

Neuro/Spine and Orthopedic Instruments

Hooks, Micro Scissors, Rhoton-Merz Retractor Set and Spetzler Headrest System

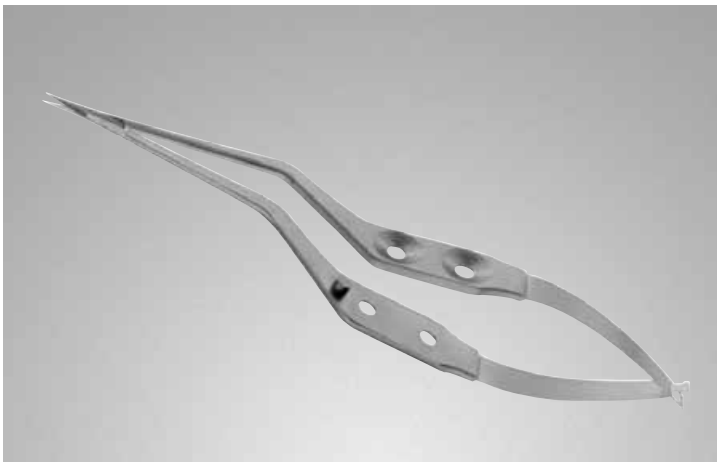

Forceps/Drills

Forceps/Forets
Zangen/Bohrer
Pinze/Trapani
Fórceps/Taladros
Fórceps/Brocas
鉗子/ドリル

RANEY Scalp Clip Applying Forceps

Opens and holds each RANEY clip for quick application.

◆ **NL10**

Overall length 6-1/4in (15.9cm).



ADSON Drill Guide and Dura Protector

NL440

Overall length 6in (15.2cm).



RANEY Scalp Hemostasis Clips

Self-clamping spring steel clips. Mirror finish.



NL20

HUDSON Brace

Standard pattern, for use with burs and drills. Mirror and Satin finish.

NL150



HUDSON Bur

NL180

Diameter 11mm.



ADSON Perforating Bur

Four square-faced blades. Speed cutting, holds sharpness well.

NL190

Diameter 14mm.



McKENZIE Perforating Twist Drill

NL200

Diameter 13mm.



HUDSON Bur

Oblong.

NL250

Diameter 14mm.



McKENZIE Enlarging Bur

◆ **NL270**

Diameter 16mm.



Pince-gouge/Scies
 Rongeur-Zangen/Sägen
 Pinza ossivora/Seghe
 Fórceps de gubias/Sierras
 Pinça saca-bocado/Serras
 骨鉗子/のこぎり

DeVILBISS Cranial Rongeur Forceps

With one extra blade.
 Overall length
 8in (20.3cm).

NL650



DAVIS Conductor

For Gigli saw. Nickle Plated.

NL750

Overall length
 8-1/4in (21cm).

BAILEY Conductor

For Gigli saw.

NL760

Overall length
 13in (33cm).



GIGLI Wire Saws

Standard type. Loops on both ends.

NL850

Overall length
 12in (30.5cm).

NL851

Overall length
 20in (50.8cm).

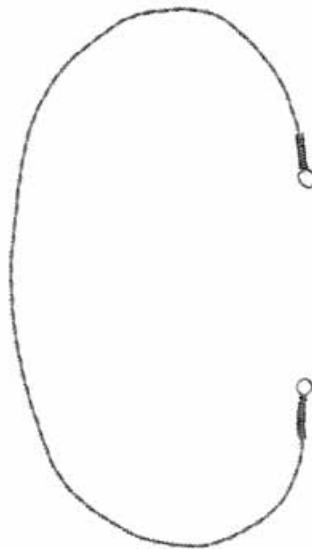

V. Mueller® GIGLI Saw

Round. Spiral surgical blade of stainless steel. Machine formed cutting edge cuts smoothly and continuously in any direction. Looped ends are carefully formed to reduce catching.

NL865

Overall length
 12in (30.5cm).

NL866

Overall length
 20in (50.8cm).

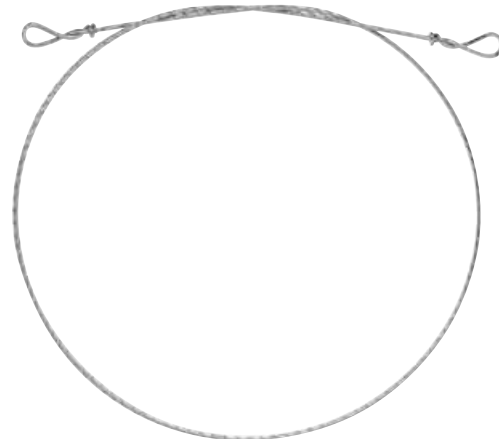

Saws/Curettes

Scies/Curettes
Sägen/Küretten
Seghe/Curette
Sierras/Curetas
Serras/Curetas
のこぎり/キュレット

Handles for GIGLI Saws

Solid T-grip handle provided with deep hook. Pair. Mirror finish.

NL880



Handles for GIGLI Saws

Loop type. 3cm x 9cm wide. 3mm wire. Pair. Mirror finish.

NL890



Chroma-Line™ Taka™ Skull Base Curettes

Overall length 7in (18cm). Straight.



Size 00000



Size 000



Size 0



Size 2

Straight

Straight	10° Angle	45° Angle	80° Angle	Cup Size	Color
U-2001	U-2016	U-2031	U-2046	00000	Silver
U-2003	U-2018	U-2033	U-2048	000	Turquoise
U-2005	U-2020	U-2035	U-2050	0	Green
U-2007	U-2022	U-2037	U-2052	2	Blue

Axial

Straight Up	Angled 10° Up	Angled 45° Up	Angled 80° Up	Cup Size	Color
U-2061	U-2076	U-2091		00000	Silver
U-2063	U-2078	U-2093	U-2108	000	Turquoise
U-2065	U-2080	U-2095		0	Green
U-2067	U-2082	U-2097	U-2112	2	Blue

Axial

Straight Down	Angled 10° Down	Angled 45° Down	Angled 80° Down	Cup Size	Color
U-2121	U-2136	U-2151		00000	Silver
U-2123	U-2138	U-2153	U-2168	000	Turquoise
U-2125	U-2140	U-2155	U-2170	0	Green
U-2127	U-2142	U-2157	U-2172	2	Blue



Straight

Axial

DAVIS-Type Brain Retractors

Overall length
7in (17.8cm).

NL1305-1

1/4in (6mm) wide.

NL1305-2

3/8in (10mm) wide.

NL1305-3

1/2in (13mm) wide.

NL1305-4

5/8in (16mm) wide.

NL1305-5

1in (25mm) wide.

**DAVIS Brain Retractors**

Flexible Silver.
Overall length
7-1/2in (19.1cm).

NL1300

1/2in (1.3cm) wide.

NL1301

5/8in (1.6cm) wide.

NL1302

3/4in (1.9cm) wide.

**CHERRY S-Shaped Brain Retractors**

Overall length
6-3/4in (17.1cm).

NL1350

10mm and 13mm wide.

NL1352

16mm and 19mm wide.

NL1354

22mm and 25mm wide.

**Silicone-Coated Brain Retractors**

Malleable. Round edges with extra silicone at the tip. Not recommended for use with lasers. Steam sterilization is recommended. Overall length 6-7/8in (17.5cm).

◆ **NL1375**

Set of four. Includes small, medium, large and extra-large retractors.

Cat. No.	Description
NL1375-001	Small. Width tapers from 6mm to 10mm wide.
NL1375-002	Medium. Width tapers from 9mm to 15mm wide.
NL1375-003	Large. Width tapers from 11mm to 20mm wide.
NL1375-004	Extra-large. Width tapers from 14mm to 25mm wide.

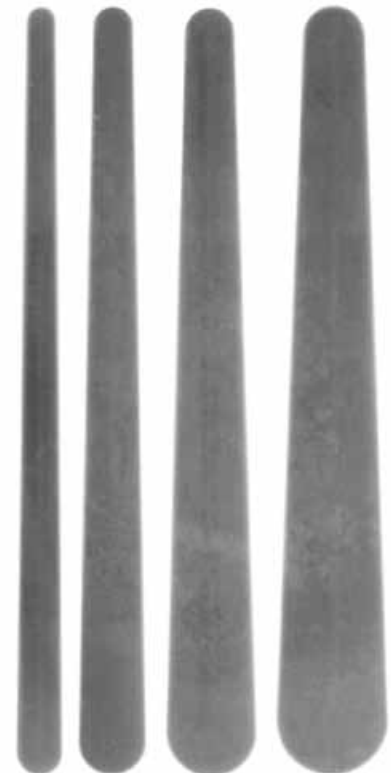

Retractors

Écarteurs
Wundspreizer/Retraktoren
Divaricatori
Separadores
Retratores
リトラクター

CUSHING Decompression Retractor

Angled. Fenestrated blade.

NL1020

Overall length
8-3/4in (22.2cm).



SACHS Vein Retractors

Angled.

NL1030

Toothed blade. Overall length
9in (22.9cm).



GIFFORD Retractor

3 x 3 blunt prongs.

AU6420

Overall length
3in (7.6cm).



ALLPORT Retractor

4 x 4 blunt prongs.

AU6400

Overall length
2-5/8in (6.8cm).



JANSEN Retractor

3 x 3 blunt prongs.

AU6410

Overall length
4in (10cm).



JANSEN Scalp Retractor

4 x 4 prongs. Total opening 3in (7.6cm).

NL900

Overall length
4-5/8in (11.7cm).



Scalp Retractor

3 x 4 sharp prongs. Total opening
3-3/4in (9.5cm).

NL955

Overall length
5-1/8in (13cm).



ADSON Cerebellum Retractor

4 x 4 prongs.

◆ **NL950**

Overall length
7-1/2in (19cm).

NL950-45

Angled 45°.
Overall length
7-1/2in (19cm).

NL950-80

Angled 80°.
Overall length
7-1/2in (19cm).



D'ERRICO-ADSON Retractor

Heavier than standard Adson, with angular shanks.

◆ **NL952**

Overall length
7-3/8in (18.7cm).



MISKIMON Cerebellar Retractor

7 sharp prongs per blade.
Blade 1-3/8in deep x 1-1/4in
(35mm x 32mm) wide.

◆ **NL960**

Overall length
8in (20.3cm).

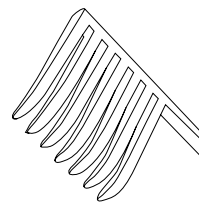

Spetzler™ Headrest System

Système de repose-tête Spetzler™
 Spetzler™ Kopfstützensystem
 Sistema poggiatesta Spetzler™
 Sistema de reposacabezas Spetzler™
 Sistema de fixação craniana Spetzler™
 Spetzler™ ヘッドレストシステム

SPETZLER Headrest System Set

Set includes the following:

Z-0200

M-1500 Clamp. (1 each)
 M-1525 Base unit. (1 each)
 M-1570 Swivel adapter. (1 each)
 Flexible arms not included with the set.



SPETZLER Skull Clamp

◆ M-1500



SPETZLER Swivel Adapter

◆ M-1570



SPETZLER Adjustable Base Unit

◆ M-1525

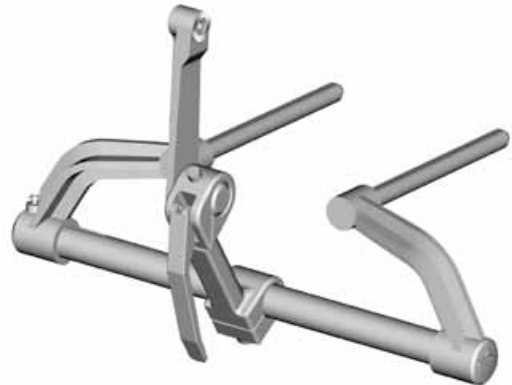

SPETZLER Skull Pins

Large.

◆ M-1535

Disposable. Sterile.
 3 pins per pack.
 12 packs per case.



SPETZLER Skull Pins

Large. Stainless Steel with silicone o-ring.

◆ M-1540

Reusable. Nonsterile.
 1 pin per pack.

M-1550

Disposable.
 Sterile. 3 pins per pack.
 12 packs per case.



SPETZLER Skull Pins

Small. Stainless Steel with silicone o-ring.

M-1545

Reusable.
 Nonsterile.
 1 pin per pack.

M-1555

Disposable. Sterile.
 3 pins per pack.
 12 packs per case.



GARDNER-WELLS Traction Tongs◆ **NL9500**

Set includes the following:

NL9501 Arch. (1 each)

NL9502 Lock nuts. (2 each)

NL9503 S-hook. (1 each)

NL9504 Test bar. (1 each)

NL9506 Spring-loaded fixation screws. (2 each)

GARDNER-WELLS Titanium Traction Tongs

Available in small, medium, and large openings. Set includes the following:

Titanium Arch. (1 each)

Titanium Lock nuts. (2 each)

Titanium S-hook. (1 each)

Titanium Test bar. (1 each)

Titanium Spring-loaded fixation screws. (2 each)

NL9510-TSmall.
Opening
7in (17.8cm).**NL9512-T**Large.
Opening
8in (20.3cm).**NL9511-T**Medium.
Opening
7-1/2in (19cm).**titanium****GARDNER-WELLS Traction Components**◆ **NL9503**

S-hook.

◆ **NL9504**

Test bar.

◆ **NL9516-T**

Titanium wrench.

NL9501

Arch only.



NL9503



NL9504

GARDNER-WELLS Lock Nuts◆ **NL9502**

Lock nuts.

NL9515-T

Titanium. Lock nuts.

**GARDNER-WELLS Fixation Screws**◆ **NL9506**Fixation screw.
Non-spring-loaded.**NL9505-S**Fixation screw.
Spring-loaded.**NL9513-T**Titanium.
Fixation screw.
Spring-loaded.**NL9514-T**Titanium.
Fixation screw.
Non-spring-loaded.

Retractors

Écarteurs
Wundspreizer/Retraktoren
Divaricatori
Separadores
Retradores
リトラクター

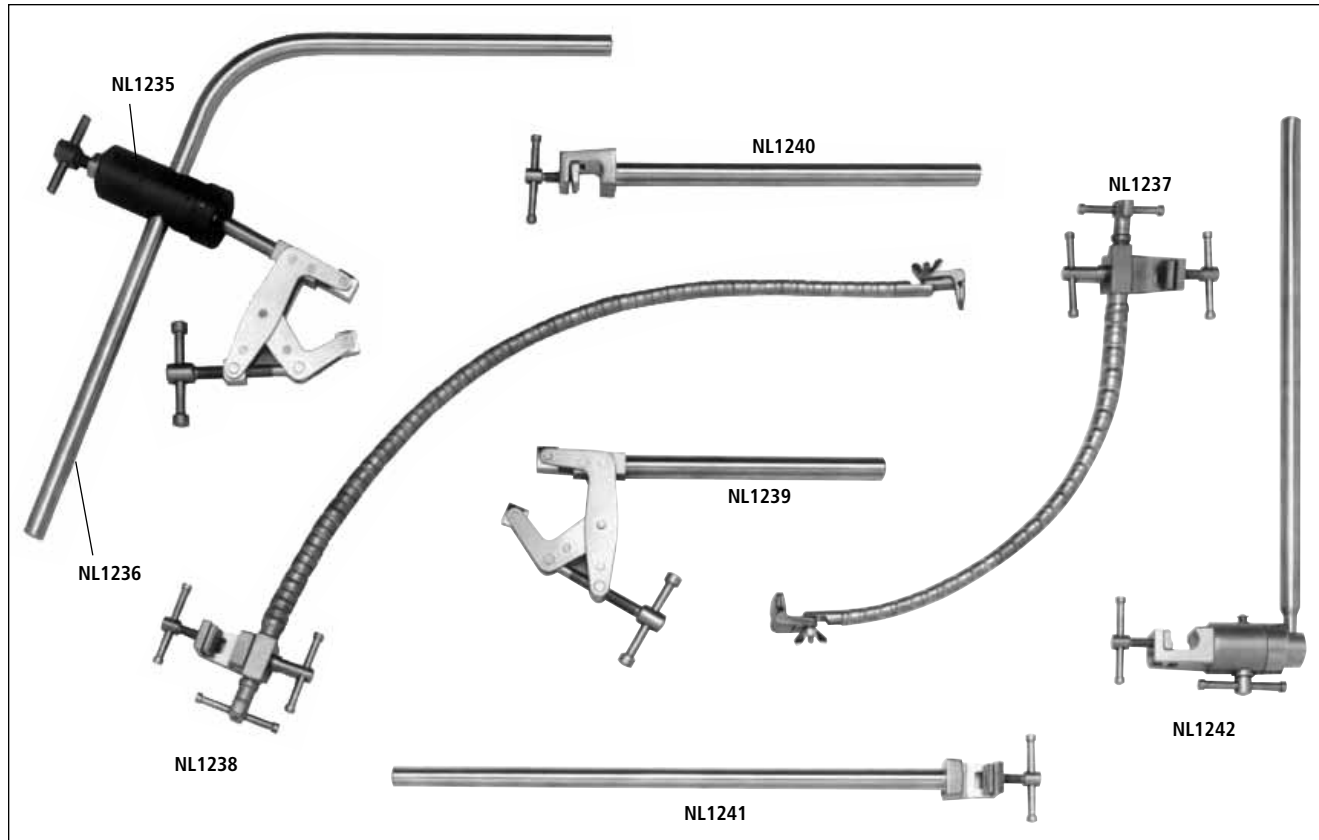

RHOTON-MERZ Brain Retractor Set

◆ NL1234

Complete set.

NL1235

Ball and Socket unit with opening to accommodate 1/2in (13mm) diameter round tubing. Clamping device to fasten to SPETZLER Head Holder.

NL1236

Holding bar, rigid, curved, 1/2in (13mm) diameter round tubing. Wall thickness 2mm, long solid plug on each end. Overall length 21in (53.3cm).

NL1237

Flexible arm for self-retaining retraction. Tapered. Length 30cm, with clamping device to fit 1/2in (13mm) round tubing.

NL1238

Flexible arm for self-retaining retraction. Tapered. Length 48cm, with clamping device to fit 1/2in (13mm) round tubing.

NL1239

Clamping unit with T-screw fitted with 1/2in (13mm) diameter round tubing. Attaches to the SPETZLER Pinion Head Holder.

NL1240

Clamping device fitted with 1/2in (13mm) diameter round tubing, 8in (20.3cm) long. Attaches to the clamping unit which attaches to the SPETZLER Head Holder.

NL1241

Clamping device fitted with 1/2in (13mm) diameter round tubing, 12in (30.5cm) long. Attaches to the clamping unit which attaches to the SPETZLER Head Holder.

NL1242

The clamping device will accommodate the 1/2in (13mm) diameter round tubing, 12in (30.5cm) long. Attaches to the clamping unit which attaches to the SPETZLER Head Holder.

RHOTON Malleable Steel Retractors

With square end tips.

◆ **NL3785-250**Tips 6mm and 10mm wide. Center 5mm.
Overall length 8-1/4in (21cm).◆ **NL3785-263**

Tips 10mm and 20mm wide. Ends taper from 20mm to 10mm and from 25mm to 20mm. Center 14mm.

◆ **NL3785-270**

Tips 2mm and 3mm wide. Center 15mm.

◆ **NL3785-271**

Tips 4mm and 6mm wide. Center 15mm.

◆ **NL3785-251**Tips 8mm and 12mm wide. Center 7mm.
Overall length 8-1/4in (21cm).◆ **NL3785-252**Tips 14mm and 18mm wide. Center 10mm.
Overall length 8-1/4in (21cm).◆ **NL3785-253**Tips 16mm and 20mm wide. Center 12mm.
Overall length 8-1/4in (21cm).◆ **NL3785-254**Tips 22mm and 26mm wide. Center 14mm.
Overall length 8-1/4in (21cm).◆ **NL3785-255**Tips 24mm and 28mm wide. Center 16mm.
Overall length 8-1/4in (21cm).◆ **NL3785-260**Tips 3mm and 5mm wide. Ends taper from 10mm to 3mm and from 15mm to 5mm.
Center 10mm.◆ **NL3785-261**Tips 5mm and 10mm wide. Ends taper from 10mm to 5mm and from 15mm to 10mm.
Center 10mm.◆ **NL3785-262**Tips 6mm and 15mm wide. Ends taper from 20mm to 6mm and from 20mm to 15mm.
Center 14mm.

NL3785-253

NL3785-261

NL3785-251

NL3785-255

NL3785-250

NL3785-252

NL3785-271

NL3785-263

NL3785-254

NL3785-262

NL3785-270

NL3785-260

**WIET Flexible Arm**

The retractor system features a short, flexible arm that's easy to manage. Once adjusted into position, it is securely locked in place with a clamping device. The arm is designed to hold retractor blades such as the JANNETTA retractor blades or RHOTON-MERZ malleable retractor blades.

○ **NL1186**Overall length
9-3/4in (24.8cm).○ **NL1186-001**

Clamping device only. Fits any self-retaining retractor with a 1/2in (13mm) maximum bar. Provides a post for mounting WIET Flexible Arm.

**LEYLA Self-Retaining Brain Retractor Set**○ **NL1277**

Includes the following:

- NL1277-002 1 Fixation Base for two Flexible Arms
- NL1275-002 2 Flexible Arms
- NL1275-003 2 Supports for Flat Brain Spatulas

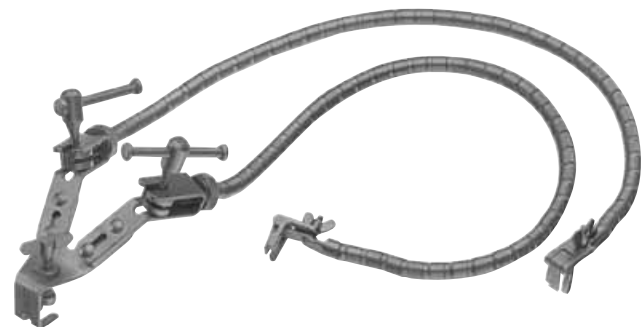

Retractors

Écarteurs
Wundspreizer/Retraktoren
Divaricatori
Separadores
Retradores
リトラクター

Fixation Base

For mounting on two flexible arms.

NL1277-002



LEYLA Flexible Arm

Flexible in all directions.

NL1275-002



V. Mueller Instrument Warranty

We warranty every medical device and accessory bearing the V. Mueller brand name to be free of functional defects in workmanship and materials when used normally for its intended use. Any V. Mueller product proving to be so defective will be replaced or repaired at no charge. Repairs or modifications performed by unauthorized personnel may void all product warranties and could affect performance and efficacy of the device.

Support for Flat Brain Spatulas

For mounting on flexible arms.

NL1275-003



Support

For round shaped instruments (suction tubes, light carriers, electrodes, etc.) with diameters up to 5.5mm.

NL1278-005



Fixation Base

For mounting on one flexible arm.

NL1275-001



Écarteurs
Wundspreizer/Retraktoren
Divaricatori
Separadores
Retratores
リトラクター

Rigid Holding Rod

Attaches to sliding rail (sizes up to 28mm) of operating tables.

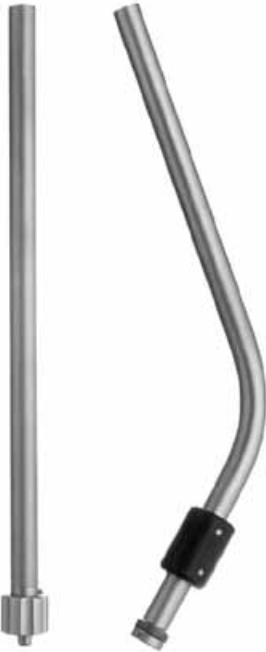
NL1279-002**Ball Joint Block**

For holding NL1279-002 rigid holding rod; attaches to sliding rail of operating tables. Sizes up to 1-1/8in (28mm). Holding rod not included.

NL1279-001**RHOTON-MERZ Rotatable Coupling Head**

Improved construction with precisely meshing teeth to secure flexible arm(s). Coupling provides maximal flexibility in selecting a position for retractor by rotating 360° on holding bar and having a head which allows retractor arms to be rotated 360° on coupling. Once proper position is selected, it can be secured firmly in position. Can be used with components and accessories for LEYLA Retractor.

NL1279-004**Coupling Head**

For fixing 1-5 flexible arms NL1275-002 for holding spatulas, suction tubes, illuminators, etc.

NL1279-003**DAVIS Brain Spatulas**

Double-ended. Overall length 8in (20.3cm).

NL1310

Ends 10mm and 13mm wide.

NL1311

Ends 22mm and 25mm wide.

**CUSHING Brain Spatula**

Tapers from 25mm to 13mm wide. Silver Plated.

NL1340

Overall length 8-1/4in (21cm).



Spatulas/Elevators/Retractors

Spatules/Élévateurs/Écarteurs
 Spatel/Heber/Wundspreizer/Rektoren
 Spatole/Elevatori/Divaricatori
 Espátulas/Elevadores/Separadores
 Espátulas/Elevadores/Retradores
 ヘラ/エレベーター/リトラクター

TAKA Brain Spatulas

Stainless Steel. Malleable.
 Overall length
 8in (20cm).

S-0810

2.2mm tip.

S-0811

3.8mm tip.

S-0812

5.8mm tip.

S-0813

7mm tip.



TAKA Super Flexible Brain Spatulas

Ebonized. Malleable.
 Overall length
 9in (22.9cm).

S-0814

2.2mm tip.

S-0815

3.8mm tip.

S-0816

5.8mm tip.

S-0817

7mm tip.



DAVIS Spatula

Semi-sharp.
 Mirror and Satin finish.

NL2760

Overall length
 7-5/8in (19.4cm).



SACHS Nerve Separator Spatula

One-piece construction.



NL2750

Overall length
 7-3/4in (19.7cm).



Spatulas

Knurled handle.

NL2770

Overall length
 6-3/4in (17cm).

NL2771

Overall length
 8-1/2in (21.6cm).



HORSLEY Dura Separator

Tempered Steel blade,
 45mm x 6.5mm wide.

NL710

Overall length
 6-3/4in (17.2cm).



CARROLL-Type Periosteal Elevator

Double-ended.
 Round blade 3mm wide.
 Flat blade 10mm wide.

NL1130

Overall length
 5-1/2in (14cm).

NL1131

5mm x 9mm blades.



MURPHY Ball Retractor

Overall length
 9in (23cm).

NL1099

2.3mm ball tip.



Élévateurs/Dissecteurs
 Heber/Dissektoren
 Elevatori/Dissettori
 Elevadores/Disecionadores
 Elevadores/Escalpelos
 エレベーター/切開器

FRAZIER Dura Elevator

One-piece construction.

NL2810

Overall length
 6-1/4in (16.0cm).

**PENFIELD Dissector No. 1**

Double-ended, broad curved dissector and sharp round spoon.

NL1090

Overall length
 7-1/2in (19.1cm).

**PENFIELD Dissector No. 2**

Double-ended, curved dissector and wax packer.

NL1091

Overall length
 7-3/8in (18.7cm).

**PENFIELD Dissector No. 3**

Double-ended, fully curved dissector and wax packer.

NL1092

Overall length
 7-1/4in (18.4cm).

**PENFIELD Dissector No. 4**

Light, slightly curved.

◆ **NL1093**

Overall length
 8-1/2in (21.6cm).

**PENFIELD Dissector No. 5**

Double-ended, slightly curved dissector ends.

NL1094

Overall length
 11-1/2in (29.2cm).

**SUNDT Ball Tip Dissector**

Matte and Mirror finish.

NL1098

Overall length
 7in (17.8cm).

**CRILE Knife and Dissector**

Double-ended.

NL2780

Overall length
 8-1/2in (21.6cm).



Couteaux/Aiguilles/Sondes/Crochets
 Messer/Nadeln/Sonden/Haken
 Bisturi/Aghi/Sonde/Uncini
 Cuchillos/Agujas/Sondas/Ganchos
 Facas/Agulhas/Sondas/Ganchos
 ナイフ/針/プローブ/フック

JACOBSON Vessel Knife

Pointed, concave blade.



CH8586

Overall length
 7-1/4in (18.4cm).



ADSON Sharp Knife



NL2600

Overall length
 8in (20.3cm).



ADSON Aneurysm Needle

Angled right.
 Tip 2mm wide.

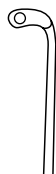

NL2700

Overall length
 9in (22.9cm).



JACOBSON Probe

Angled, ball-pointed tip.
 Mirror and Satin finish.



NL3084

Overall length
 7-1/4in (18.4cm).



JACOBSON Probe

Straight, two ball tips. Mirror
 and Satin finish.



NL3085

Overall length
 7-1/4in (18.4cm).



KILNER Sharp Hook

Hook diameter 2mm. Solid
 knurled handle.



NL2401

Overall length
 6in (15.2cm).



FRAZIER Dura Hook

Hollow handle.

NL2440

Overall length
 6in (15.2cm).



GRAHAM Blunt Hook

One-piece construction.

NL2470

Overall length
 6-1/2in (16.5cm).



Crochets
Haken
Uncini
Ganchos
Ganchos
フック

CLOWARD Dural Hook

Sharp hook.
Hook diameter 2.5mm.

NL2430

Overall length
6-7/8in (17.5cm).



KRAYENBUEHL Hook

Smooth end, with finger rest.
Overall length
7-1/4in (18.4cm).



NL3088

Small.



KRAYENBUEHL Hooks

Probe pointed tip, with finger rest. Overall length
7-3/8in (18.7cm).

NL3086

Small.

NL3087

Large.



WEARY-Type Nerve Hook

Tip diameter 0.9mm,
depth 3mm. Black finish.

NL3095

Overall length
7-3/4in (19.7cm).



ADSON Dural Hook

Hollow handle.
Sharp tip, 5mm long.

NL2400

Overall length
8in (20.3cm).



ADSON Dissecting Hook

Blunt hook, depth 5mm.

NL2710

Overall length
8in (20.3cm).



ADSON Blunt Dissecting Hook

Tip length 5mm.

NL2410

Overall length
8-1/4in (20.8cm).



SMITHWICK Nerve Hook

NL2460

Overall length
8-1/4in (21cm).



Hooks/Forceps

Crochets/Forceps
Haken/Zangen
Uncini/Pinze
Ganchos/Fórceps
Ganchos/Fórceps
フック/鉗子

DANDY Nerve Hooks

Overall length
8-1/2in (21.6cm).

NL2490

Pointed left.

NL2491

Straight.

NL2492

Pointed right.



Nerve Hook

NL2493

Overall length
9-1/2in (24.1cm).



YASARGIL Spring Hook

NL101

Large.



CAIRNS (DANDY) Hemostatic Forceps

Curved on side.

NL90

Overall length
5-1/2in (14cm).



ADSON Hemostatic Forceps



NL3500

Straight.
Overall length
8-1/2in (21.6cm).



NL3520

Straight.
Overall length
7-1/4in (18.4cm).



NL3510

Curved.
Overall length
8-1/2in (21.6cm).



◆ **NL3530**

Curved.
Overall length
7-1/4in (18.4cm).



Spinal Ligament Forceps

Serrated tips. 1 x 2 teeth.

NL91

Overall length
7-1/4in (18.4cm).



ACLAND Microvascular Clamp Applying Forceps

Straight.

NL3196

Overall length
4-3/8in (11cm).



ACLAND Single Clamps

NL3196-001

Overall length
8mm.

NL3196-002

Overall length
11mm.

NL3196-003

Overall length
14mm.

NL3196-004

Overall length
17mm.



ACLAND Double Clamps

With frame for stay sutures.

NL3197-001

Overall length
8mm.

NL3197-002

Overall length
11mm.



ACLAND Double Clamp Approximators

Movable.



With Frame	Without Frame	
Cat. No.	Cat. No.	Length
NL3198-001	NL3199-001	8mm
NL3198-002	NL3199-002	11mm
NL3198-003	NL3199-003	14mm
	NL3199-004	17mm

Spoons/Mirrors/Scissors

Cuillers/Miroirs/Ciseaux
 Löffel/Spiegel/Scheren
 Cucchiari/Specchi/Forbici
 Cucharas/Espejos/Tijeras
 Colheres/Espeelhos/Tesoura
 スプーン/鏡/鋏

CUSHING Pituitary Spoons

Silver Plated. Overall length 9-1/4in (23.5cm).



NL2900
 Small, size 1.



NL2902
 Large, size 3.



NL2901
 Medium, size 2.



APFELBAUM Micro Mirrors

Round, knurled handle, malleable shaft.
 Matte and Mirror finish. Working length
 4-1/2in (11.4cm).

NL3780

4mm diameter glass mirror.

NL3781

6mm diameter glass mirror.



STEVENSON Alligator Scissors

Delicate. Working length 5-3/8in (13.7cm).

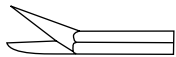

NL3720
 Sharp/Sharp.

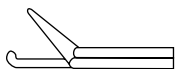

NL3722
 With 1.5mm guard on
 blunt dissector.



JANNETTA-KURZE (Modified) Dissecting Scissors

Curved to the left. Blade length 8.5mm.

NL3800-001

Working length
 5-3/8in (13.7cm).

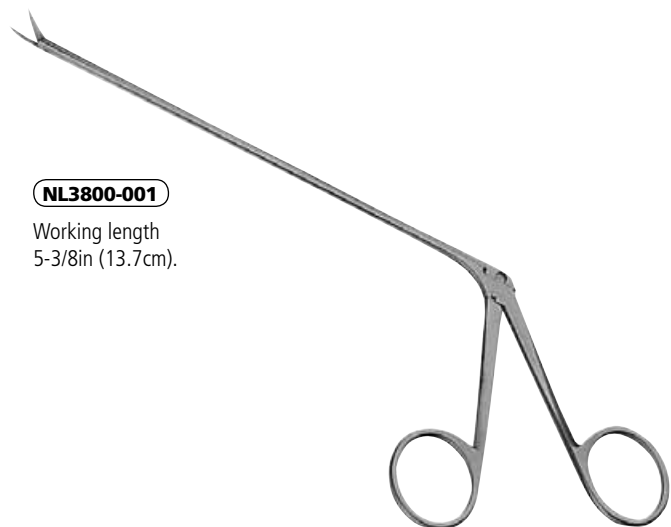

KURZE Dissecting Scissors

Blade length 9mm. Working length 5-1/2in (13.7cm).

NL3799

Straight.

NL3800

Curved to the left.



KURZE Dissecting Scissors.

Curved to right.

NL3801

Working length
5-1/2in (14cm).

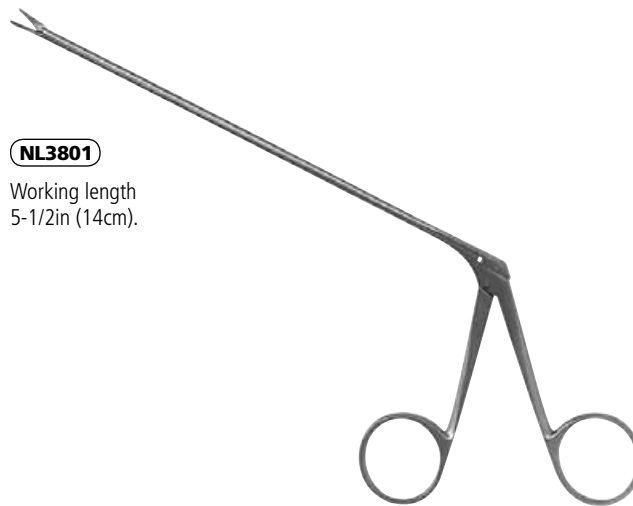

TINDALL Scissors

Blades angled up.

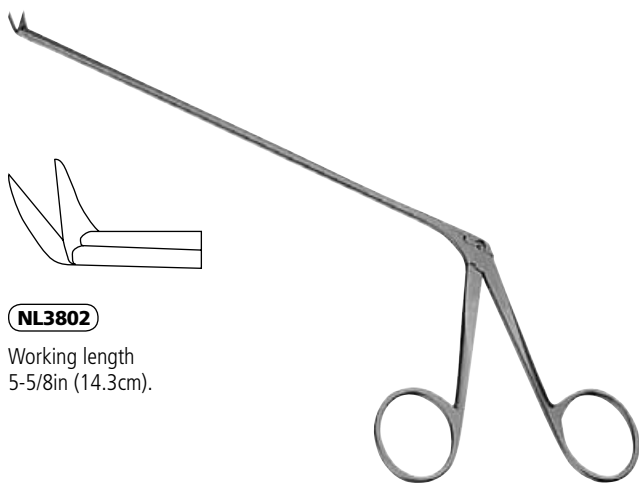

NL3802

Working length
5-5/8in (14.3cm).

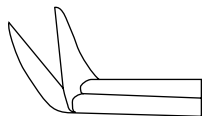

Microsurgery Scissors

Pencil-grip type handle.
Overall length
7-1/4in (18.4cm).



NL3810

Straight blades.

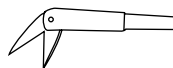

NL3811

Angled blades.



Scissors

Ciseaux
Scheren
Forbici
Tijeras
Tesoura
鋏

YASARGIL Micro Scissors

Bayonet shaped.

NL4001

Curved upward.
Blade length 11mm.
Overall length
6-1/2in (16.5cm).

NL4000

Straight.
Blade length 11.5mm.
Overall length
6-1/2in (16.5cm).

NL4002

Curved downward.
Blade length 12mm.
Overall length
8in (20.3cm).

NL4004

Curved upward.
Blade length 12mm.
Overall length
8in (20.3cm).

NL4003

Straight.
Blade length 12.5mm.
Overall length
8in (20.3cm).

NL4005

Straight.
Overall length
9in (22.9cm).



MALIS Titanium Bayonet Scissors

Working length 3-3/4in (9.5cm).
Overall length 9-1/2in (24.1cm).

NL4010-T

Straight. Regular tips.

NL4015-T

Curved. Regular tips.

NL4020-T

Curved down. Regular tips.

NL4025-T

Straight. Delicate tips.

NL4030-T

Curved up. Delicate tips.

titanium



YASARGIL Micro Scissors

Overall length 8-3/4in (22.2cm).

NL4006

Tapered tip, curved upward.
Blade length 12.5mm.

NL4007

Straight.
Blade length 16.5mm.

NL4008

Curved upward.
Blade length 16.5mm.



JANNETTA Bayonet Shaped Scissors

Very delicate curved blades, sharp points.
Blade length 9mm.
Spring handle.

NL3778

Overall length
7-1/4in (18.4cm).



TAYLOR Brain Scissors

Angled-on-side, slightly curved shanks, one probe-tipped blade. Mirror finish.

NL3010

Overall length
6in (15.2cm).

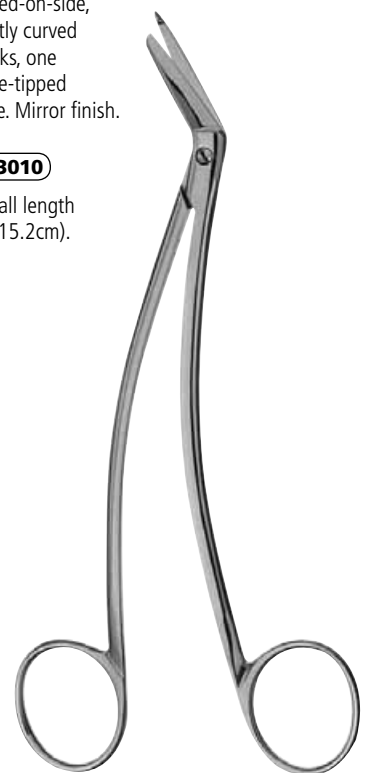

Ciseaux/Porte-aiguilles
Scheren/Nadelhalter
Forbici/Porta-ago
Tijeras/Sostenes de agujas
Tesoura/Porta-agulhas
鉏/針ホルダー

DANDY Neurosurgical Scissors

Shanks angled-on-flat.

NL3030

Overall length
6-3/4in (17.1cm).



MALIS Scissors

Semi-sharp tips.
Curved.

NL3006

Overall length
7in (17.8cm).



DeMARTEL Scissors

Sharp/Sharp. Delicate.
Curved blades, length
3cm from mid-screw.
Mirror finish.

NL3002

Overall length
7-3/4in (19.6cm).



STRULLY Dissecting Scissors

Curved blades, probe tips.

NL3020

Overall length
8-3/4in (22.2cm).



Vital® Microsurgical Needle Holders

Tungsten Carbide inserts.



NL3754

Smooth jaws.
Overall length
5in (12.7cm).



NL3750

Finely cross-serrated jaws.
3,600 teeth per square inch.
Overall length
6in (15.2cm).



NL3752

Finely cross-serrated jaws.
3,600 teeth per square inch.
Overall length
5in (12.7cm).

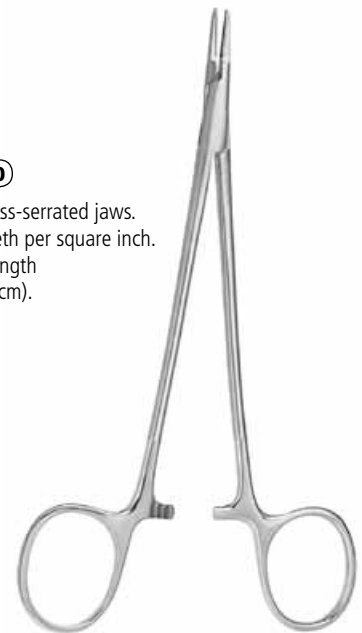

Forceps

Forceps
Zangen
Pinze
Fórceps
Fórceps
鉗子

Micro-Tubal Needle Holders



GL4411

Curved jaws.
Overall length
7in (17.8cm).



Micro Forceps

Straight, without platform.



GL4210

Overall length
6in (15.2cm).



Micro Tissue Forceps

Straight. 1 x 2 teeth.
Size 0.3mm. 6mm platform.



GL4212

Overall length
6in (15.2cm).



Micro Forceps

1cm platform.
Overall length 6in (15.2cm).



GL4213

Curved.



GL4211

Straight.



GERALD Forceps

Delicate.



◆ **NL1440**

1 x 2 teeth.
Overall length
7in (17.8cm).



◆ **NL1450**

Serrated tips.
Overall length
7in (17.8cm).



GERALD Forceps

Straight. Flat handle. Serrated tips.

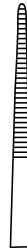

NL1445

Overall length
9-1/4in (23.5cm).



GERALD-DeBAKEY Tissue Forceps

Tips 1mm wide.



NL1451

Overall length
7in (17.8cm).

NL1452

Overall length
8in (20.3cm).



Vital® Micro GERALD Forceps

NL1457

Fine tips tapered to 1mm wide.
Overall length 7in (17.8cm).



NL1453

Delicate, extra-fine tips
tapered to 1mm wide.
Overall length 7in (17.8cm).

NL1454

Delicate, extra-fine tips
tapered to 1mm wide.
Overall length 9in (22.9cm).



CUSHING Dressing Forceps

Serrated. Semi-sharp dissecting end.



NL1480

Overall length
7in (17.8cm).

NL1481

Overall length
8in (20.3cm).



CUSHING Dressing Forceps

Bayonet. Serrated,
square dissecting tip.



◆ **NL1560**

Overall length
7-5/8in (19.4cm).



Forceps

Forceps
Zangen
Pinze
Fórcps
Fórcps
鉗子

CUSHING Tissue Forceps

1 x 2 teeth. Semi-sharp dissecting end.



NL1470

Overall length
7-1/4in (18.4cm).

NL1471

Overall length
8in (20.3cm).



CUSHING Tissue Forceps

Gutsch handle.
Overall length 7in (17.8cm).

NL1561

Serrated tips.

NL1571

1 x 2 teeth.

NL1565

Serrated tips.
1 x 2 teeth.



CUSHING Tissue Forceps

Bayonet. Serrated. 1 x 2 teeth.
Square dissecting tip.



NL1570

Overall length
7-5/8in (19.4cm).



Vital® CUSHING Tissue Forceps

Straight. Delicate jaws.
Tungsten Carbide inserts.
3,600 teeth per square inch.



NL1460

Overall length
7in (17.8cm).



Vital® CUSHING Tissue Forceps

Angled tips. Tungsten Carbide inserts.
3,600 teeth per square inch.



NL1462

Overall length
6-3/4in (17cm).



Vital® CUSHING Tissue Forceps

Bayonet. Tungsten Carbide tips and dissecting end.



NL1464

Overall length
7-1/4in (18.5cm).



ADSON Dressing Forceps

Bayonet. Fine, serrated tips.



NL1550

Overall length
7-1/8in (18.1cm).



D'ERRICO Tissue Forceps

1 x 2 teeth.



NL1500

Overall length
7-1/4in (18.4cm).



D'ERRICO Dressing Forceps

Bayonet shape. Serrated.



NL1580

Overall length
8-7/8in (22.5cm).



D'ERRICO Hypophyseal Forceps

Bayonet shaped, straight shanks.
Overall length 8-3/4in (22.2cm).



NL3610

Cupped jaws,
6.5mm x 6.5mm.

NL3611

Cupped jaws,
3mm x 3mm.

NL3612

Cupped jaws,
5mm x 5mm.



MALIS Titanium Bayonet Forceps

Working length 3-1/2in (8.9cm).
Overall length 8-3/4in (22.2cm).

NL1581-T

Straight. Delicate tips.



Looking for a specific product?

When you know the catalog number or the name of the product you need, you can use the index at the end of this book to direct you to the page on which the product is described. If you do not find the specific instruments you are looking for, please contact your local V. Mueller sales representative or Customer Support at **800.323.9088**.

Canules/Aiguilles/Forceps
 Kanülen/Nadeln/Zangen
 Cannule/Aghi/Pinze
 Cánulas/Agujas/Fórceps
 Cânulas/Agulhas/Fórceps
 カニューレ/針/鉗子

HAYNES Brain Cannulas

Graduated in centimeters.
 Diameter 13GA. Mirror finish.

NL2100

Working length
 4in (10.2cm).



CONE Ventricular Needles

Mirror finish. Working length
 3-1/2in (8.9cm).

NL2112

With 1 hole.
 Diameter 16GA.

NL2113

With 1 hole.
 Diameter 18GA.

NL2110

With 2 holes.
 Diameter 16GA.

NL2111

With 2 holes.
 Diameter 18GA.



FRAZIER Ventricular Cannulas

Graduated in centimeters.
 Diameter 12GA.
 Mirror finish.

NL2120

Working length
 2in (5.2cm).

NL2121

Working length
 2-1/8in (5.4cm).

NL2122

Working length
 3-1/2in (8.9cm).



ADSON Exploring Cannulas

Graduated in centimeters.
 Mirror finish.
 Working length
 4in (10.2cm).

NL2151

Diameter 10GA.

NL2150

Diameter 14GA.



CONE Biopsy Cannulas

Mirror finish.
 Working length
 3-1/2in (8.9cm).

NL2280

13GA.

NL2281

15GA.



Microsurgery Biopsy Forceps

Straight. Cup-shaped jaws.
 Diameter 1mm.
 Pencil-grip type handle.



NL3826

Overall length
 7-1/4in (18.4cm).

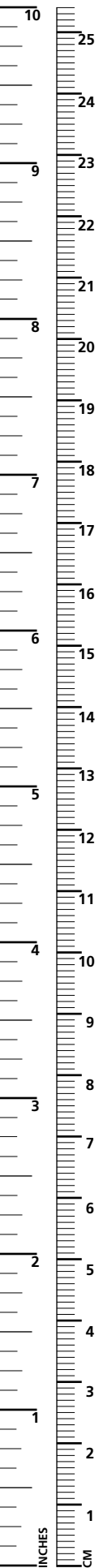

STEVENSON Grasping Forceps

Straight. 6mm jaws. Alligator type shank.



NL3700

Working length 5-1/8in (13cm).



STEVENSON Cupped Jaw Forceps

Alligator type shank. Working length 5-1/8in (13cm).



NL3704

Jaws angled to 80°, opening to the right side.

NL3708

Jaws angled to 45°, open to left side.



JANNETTA Alligator Grasping Forceps

Delicate. Working length 5-3/8in (13.7cm).



NL3698-001

Straight.

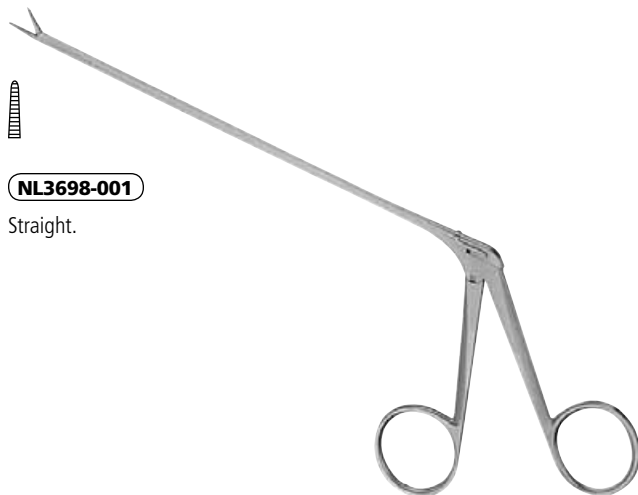

Customer Support

Our highly trained, centralized V. Mueller customer support team is available to take your calls from 7:00 a.m. to 6:00 p.m. (CST), M-F. This group is dedicated to providing a full range of support services, including:

- Order placement
- Order inquiries
- Delivery information
- Product information
- Pricing inquiries

If we can be of assistance, please call us at **800.323.9088**.

Rhoton Scissors/Needle Holders

Ciseaux Rhoton/Porte-aiguilles
 Rhoton-Scheren/Nadelhalter
 Forbici Rhoton/Porta-ago
 Tijeras Rhoton/Sostenes de agujas
 Tesoura Rhoton/Porta-agulhas
 Rhoton鉋/針ホルダー

RHOTON Micro Scissors

Blades angled 60°. Overall length 6-7/8in (17.5cm).

NL3785-047



NL3785-048

Blades curved right.

NL3785-049

Blades curved left.

RHOTON Micro Surgical Scissors

Cutting blades 5.5mm long.

NL3785-028

Straight.
 Overall length
 7-1/2in (19.1cm).

NL3785-029

Blades angled up 45°. Overall length
 7-3/8in (18.7cm).

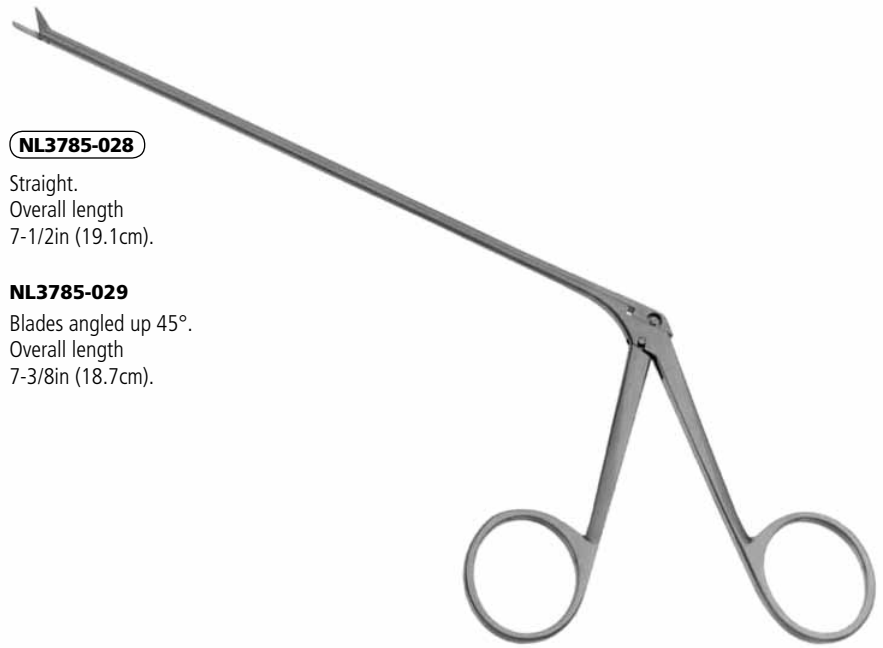

RHOTON Micro Scissors

Mirror and Satin finish.
 Overall length
 7in (17.8cm).

NL3785-030

Straight.

NL3785-031

Curved.



RHOTON Micro Needle Holders

Round handle. Overall length
 7in (17.8cm).



NL3785-036

Straight jaws.



NL3785-038

Curved jaws.



RHOTON Micro Needle Holders

With catch. Overall length
 7in (17.8cm).



NL3785-037

Straight jaws.



NL3785-039

Curved jaws.

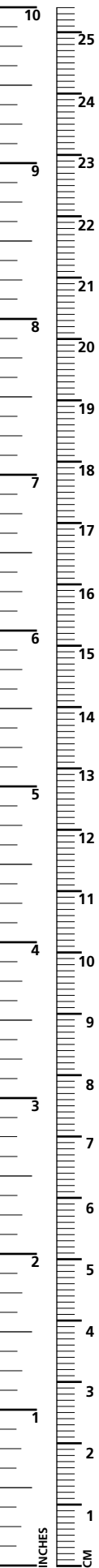

Forceps Rhoton
Rhoton-Zangen
Pinze Rhoton
Fórceps Rhoton
Fórceps Rhoton
Rhoton 鉗子

RHOTON Micro Tying Forceps

0.75mm tip. Overall length
7in (17.8cm).



NL3785-045

Straight.



NL3785-046

Curved.



RHOTON Micro Forceps

Straight. Overall length
7in (17.8cm).



NL3785-052

Extra-fine. 0.3mm tips.



NL3785-053

Fine. 0.5mm tips.



RHOTON-ADSON Dressing Forceps

Serrated.

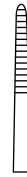

NL3785-056

Overall length
7-1/8in (18.1cm).



RHOTON-ADSON Tissue Forceps

1 x 2 teeth.



◆ **NL3785-057**

Overall length
7-1/8in (18.1cm).



RHOTON Tissue Forceps

Straight. 1 x 2 teeth.



NL3785-059

Overall length
7in (17.8cm).



RHOTON Micro Vascular Forceps

Straight. Serrated tips, 3mm wide with groove
down middle.



NL3785-058

Overall length
7-1/8in (18.1cm).



Rhoton Scissors/Needle Holders/Forceps

Ciseaux Rhoton/Porte-aiguilles/Forceps
 Rhoton-Scheren/Nadelhalter/Zangen
 Forbici Rhoton/Porta-ago/Pinze
 Tijeras Rhoton/Sostenes de agujas/Fórceps
 Tesoura Rhoton/Porta-agulhas/Fórceps
 Rhoton鉈/針ホルダー/鉗子

RHOTON Bayonet Scissors

Mirror and Satin finish.

NL3785-032

Straight 8cm shaft.
 Overall length
 8-3/8in (21.3cm).

NL3785-033

Curved 8cm shaft.
 Overall length
 8-3/8in (21.3cm).

NL3785-034

Straight 9.5cm shaft.
 Overall length
 9-1/8in (23.2cm).

NL3785-035

Curved 9.5cm shaft.
 Overall length
 9-1/8in (23.2cm).

NL3785-340

Straight extra-long
 11cm shaft.
 Overall length
 9-7/8in (25.1cm).

NL3785-350

Curved extra-long
 11cm shaft.
 Overall length
 9-7/8in (25.1cm).



RHOTON Bayonet Needle Holders



NL3785-040

Straight 8cm shaft.
 Overall length
 9-1/4in (23.5cm).

NL3785-042

Straight 6cm shaft.
 Overall length
 8-1/4in (21cm).



NL3785-041

Curved 8cm shaft.
 Overall length
 9-1/4in (23.5cm).

NL3785-043

Curved 6cm shaft.
 Overall length
 8-1/4in (21cm).



RHOTON-CUSHING Dressing Forceps

Serrated jaws, 8cm shaft.



NL3785-060

Overall length
 7-7/8in (20cm).



RHOTON-CUSHING Tissue Forceps

1 x 2 teeth. Tips 5mm.
 Shaft 8cm.



NL3785-061

Overall length
 7-7/8in (20cm).



RHOTON Grasping Forceps

Serrated ring tip,
 2.6mm.

NL3785-066

Shaft 8cm.
 Overall length
 8in (20cm).

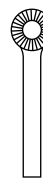

NL3785-065

Shaft 9.5cm.
 Overall length
 9in (22.9cm).



RHOTON Micro Dissecting Forceps

Bayonet. Finely serrated
 tips .75mm.

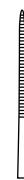

NL3785-062

Shaft length 11cm.
 Overall length
 9-3/8in (23.8cm).

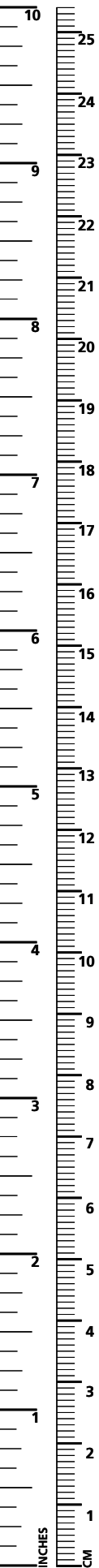

Forceps Rhoton/Emporte-pièces
 Rhoton-Zangen/Stanzen
 Pinze Rhoton/Punzoni
 Fórceps Rhoton/Sacabocados
 Fórceps Rhoton/Punções
 Rhoton 鉗子/穿孔

RHOTON Cup Forceps

Cup 0.5mm wide.
 Working length 5-3/8in (13.7cm).

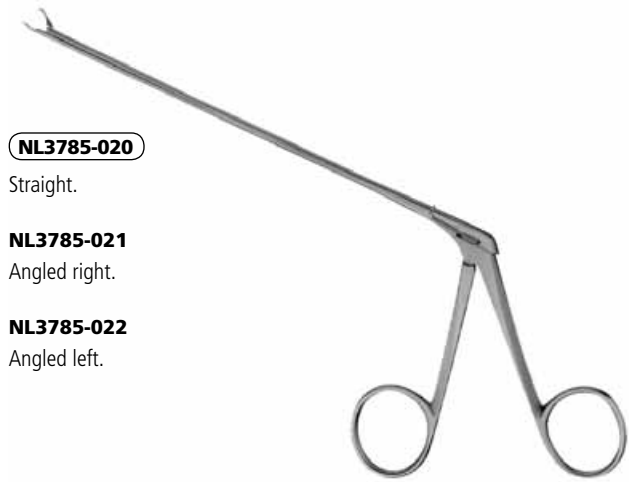

NL3785-020

Straight.

NL3785-021

Angled right.

NL3785-022

Angled left.

RHOTON Cup Forceps

Cup 1mm wide. Working length
 5-3/8in (13.7cm).

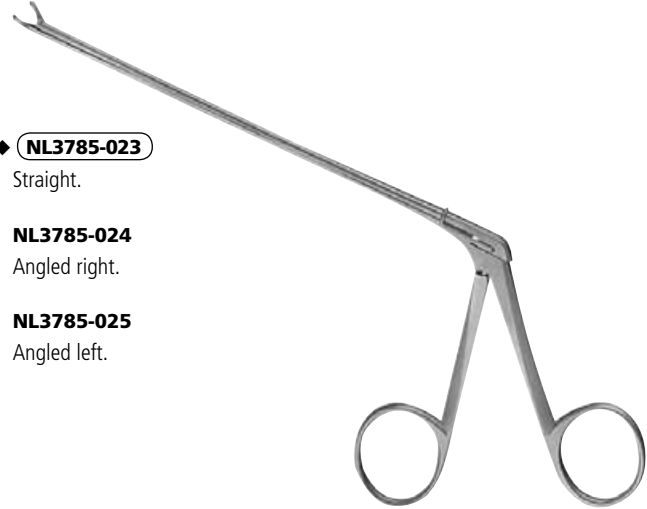

◆ **NL3785-023**

Straight.

NL3785-024

Angled right.

NL3785-025

Angled left.

RHOTON Cup Forceps

Straight. Working length
 5-3/8in (13.7cm).

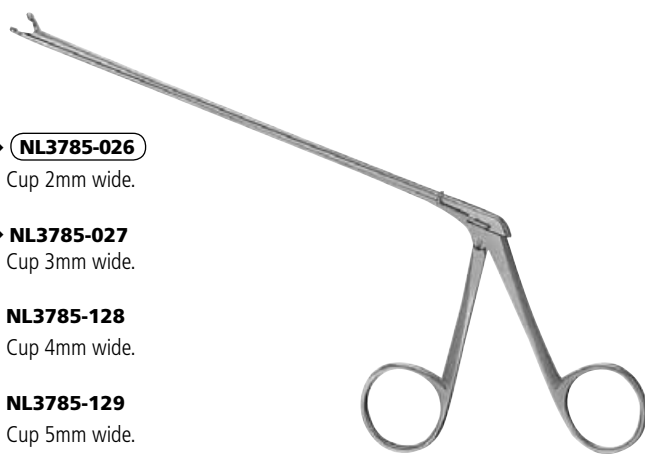

◆ **NL3785-026**

Cup 2mm wide.

◆ **NL3785-027**

Cup 3mm wide.

NL3785-128

Cup 4mm wide.

NL3785-129

Cup 5mm wide.

RHOTON Punches

Working length 8in (20.3cm).
 Overall length
 10-3/4in (27.3cm).

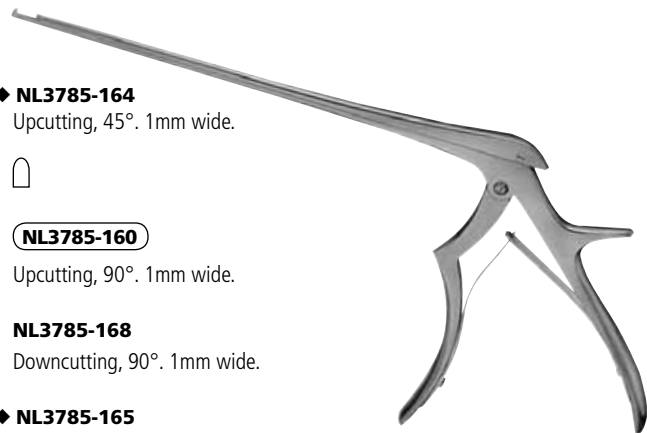

◆ **NL3785-164**

Upcutting, 45°. 1mm wide.



NL3785-160

Upcutting, 90°. 1mm wide.

NL3785-168

Downcutting, 90°. 1mm wide.

◆ **NL3785-165**

Upcutting, 45°. 2mm wide.



NL3785-161

Upcutting, 90°. 2mm wide.

NL3785-169

Downcutting, 90°. 2mm wide.

Dissecteurs Rhoton/Élévateurs/Crochets/Aiguilles/Curettes
 Rhoton-Dissektoren/Heber/Haken/Nadeln/Küretten
 Dissettori Rhoton/Elevatori/Uncini/Aghi/Curette
 Diseccionadores Rhoton/Elevadores/Ganchos/Agulhas/Curetas
 Escalpelos Rhoton/Elevadores/Ganchos/Agulhas/Curetas
 Rhoton切開器/エレベーター/フック/針/キュレット

RHOTON Microsurgical Instruments

Complete set of 20 instruments in rack.

NL3785

Includes NL3785-001 through NL3785-20.

titanium

RHOTON Round Dissectors

Overall length 7-1/2in (19.1cm).



NL3785-001

Diameter 1mm.

NL3785-001T

Titanium. Diameter 1mm.

NL3785-002

Diameter 2mm.

NL3785-002T

Titanium. Diameter 2mm.

NL3785-003

Diameter 3mm.

NL3785-003T

Titanium. Diameter 3mm.

titanium

RHOTON General Purpose Elevators

Overall length 7-1/2in (19.1cm).



NL3785-004

Curved.

NL3785-004T

Titanium. Curved.

NL3785-005

Angled.

NL3785-005T

Titanium. Angled.

titanium

RHOTON Spatula Dissectors

Overall length 7-1/2in (19.1cm).

NL3785-006

No. 6. Small.

NL3785-006T

Titanium. No. 6. Small.

NL3785-007

No. 7. Medium.

NL3785-007T

Titanium. No. 7. Medium.



NL3785-008

No. 8. Large.

NL3785-008T

Titanium. No. 8. Large.

titanium

RHOTON Hooks

Overall length 7-1/2in (19.1cm).



NL3785-009

Angled 90°. Semi-sharp.

NL3785-009T

Titanium. Angled 90°. Semi-sharp.

NL3785-010

Angled 90°. Blunt.

NL3785-010T

Titanium. Angled 90°. Blunt.

NL3785-011

Angled 45°. Semi-sharp.

NL3785-011T

Titanium. Angled 45°. Semi-sharp.

titanium

RHOTON Straight Point Needle

No. 12. Semi-sharp.

NL3785-012

Overall length 7-1/2in (19.1cm).

NL3785-012T

Titanium. Overall length 7-1/2in (19.1cm).

titanium

RHOTON Micro Curettes

Cup 2mm x 1mm wide. Overall length 7-1/2in (19.1cm).



NL3785-013

Straight.

NL3785-013T

Titanium. Straight.

NL3785-014

Angled.

NL3785-014T

Titanium. Angled.

titanium

Currettes Rhoton/Dissecteurs/Spéculum
 Rhoton-Küretten/Dissektoren/Spekula
 Curette Rhoton/Dissettori/Speculum
 Curetas Rhoton/Diseccionadores/Espéculos
 Curetas Rhoton/Escalpelos/Espéculos
 Rhoton キュレット/切開器/検鏡

RHOTON Angled Meatal Curette

Cup 2mm x 1mm wide.
 Overall length
 7-3/8in (18.7cm).

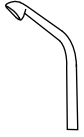

NL3785-015

Angled 130°.

RHOTON Ball Dissector

Diameter 0.8mm. Straight.
 Mirror and Satin finish.



NL3785-15

Overall length
 7-1/2in (19.1cm).

NL3785-15T

Titanium.
 Overall length
 7-1/2in (19.1cm).

RHOTON Ball Dissectors

Mirror and Satin finish.
 Overall length
 7-1/2in (19.1cm).

NL3785-16

Tip 3mm wide.
 Angled 90°.

NL3785-16T

Titanium. Tip 3mm wide.
 Angled 90°.

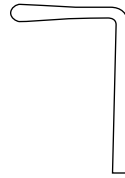

NL3785-17

Tip 5mm wide.
 Angled 90°.

NL3785-17T

Titanium. Tip 5mm wide.
 Angled 90°.



NL3785-18

Tip 4mm wide.
 Angled 40°.

NL3785-18T

Titanium. Tip 5mm wide.
 Angled 40°.

NL3785-19

Tip 8mm wide.
 Angled 40°.

NL3785-19T

Titanium. Tip 8mm wide.
 Angled 40°.

V. Mueller Instrument Detergents

To assist with the care and handling of your instruments, CareFusion offers you a full line of cleaning and decontamination products detailed in the Genesis Sterilization Containers and Instrument Processing Supplies section of this armamentarium.

RHOTON Transsphenoidal Specula

NL3785-500.

Small. Blades 3-12in (8.9cm).

NL3785-501

Rhoton Transsphenoidal Specula.
 Large. Blades 4in (101.6cm).



Rhoton Dissectors/Hooks/Curettes

Dissecteurs Rhoton/Crochets/Curettes
 Rhoton-Dissektoren/Haken/Küretten
 Dissettori Rhoton/Uncini/Curette
 Diseccionadores Rhoton/Ganchos/Curetas
 Escalpelos Rhoton/Ganchos/Curetas
 Rhoton切開器/フック/キュレット

RHOTON Knife Handle

Vertical, takes No. 11 blade.

NL3785-130

Overall length
 7-5/8in (19.4cm).



RHOTON Enucleators

Overall length
 9in (22.9cm).



NL3785-131
 Small size, right.

NL3785-132
 Small size, left.



NL3785-133
 Regular size, right.

NL3785-134
 Regular size, left.



RHOTON Round Dissector

Sharp.



NL3785-135

Overall length
 9in (22.9cm).



RHOTON Spatula Dissectors

Overall length
 9in (22.9cm).



NL3785-136

Curved up.



NL3785-137

Curved down.



RHOTON Hook
 Right angled, 3.5mm.



NL3785-138

Overall length
 9in (22.9cm).



RHOTON Vertical Ring Curettes

Blunt. Overall length
 9in (22.9cm).



NL3785-139

Diameter 6mm.

NL3785-153
 Diameter 3mm.

NL3785-154
 Diameter 9mm.

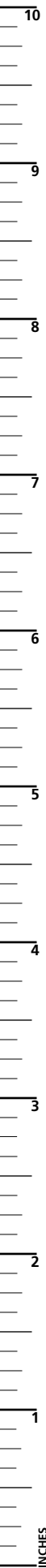

Curettes Rhoton/Ostéotomes
 Rhoton-Küretten/Osteotome
 Curette Rhoton/Osteotomi
 Curetas Rhoton/Osteótomos
 Curetas Rhoton/Osteótomos
 Rhoton キュレット/骨刀

RHOTON Horizontal Ring Curettes

Blunt. Overall length 9in (22.9cm).

NL3785-140

Diameter 6mm.

NL3785-141

Diameter 9mm.

NL3785-155

Diameter 3mm.



RHOTON Three-Prong Fork

Sharp prongs.

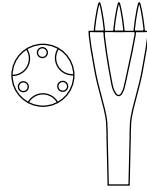

NL3785-142

Overall length 9in (22.9cm).



RHOTON Micro Curette

Angled 45°.



NL3785-143

Overall length 9in (22.9cm).



RHOTON Pituitary Curettes

Overall length 9in (22.9cm).



NL3785-144

Horizontal, angled 45°.

NL3785-145

Vertical.



RHOTON Loop Curette

Blunt. Loop faces sideways, 9mm x 5mm wide. Malleable.

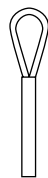

NL3785-146

Overall length 9in (22.9cm).



RHOTON Spoon Curette

Blunt. Cup faces up, 9mm x 5mm wide. Malleable. Stainless Steel.



NL3785-147

Overall length 9in (22.9cm).



RHOTON Osteotome

Especially suited for making initial opening in anterior sellar wall. 4mm wide.

NL3785-148

Overall length 7-1/2in (19.1cm).



Élévateurs Jannetta/Dissecteurs/Crochets/Couteaux
 Jannetta-Heber/Dissektoren/Haken/Messer
 Elevatori Jannetta/Dissettori/Uncini/Bisturi
 Elevadores Jannetta/Disseccionadores/Ganchos/Cuchillos
 Elevadores Jannetta/Escalpelos/Ganchos/Facas
 Jannetta 昇降器/切開器/フック/ナイフ

JANNETTA Angular Knives

Mirror and Satin finish. Overall length 7-1/2in (19.1cm).



NL3760

Small, 2mm diameter.



NL3761

Large, 2.5mm diameter.



JANNETTA Duckbill Elevator

Curved tip, 2.7mm wide. Angled shaft.



NL3762

Overall length 7-1/2in (19.1cm).



JANNETTA Angular Elevator

Tip 1.1mm wide.



NL3763

Overall length 7-1/2in (19.1cm).



JANNETTA Dissectors

Curved blade. Overall length 7-1/2in (19.1cm).

NL3764

Small. Tip 1.6mm wide.



NL3765

Large. Tip 2mm wide.



JANNETTA Right Angle Hooks

Overall length 7-1/2in (19.1cm).



NL3766

Small. Tip length 2mm.

NL3768

Medium. Tip length 3.5mm.

NL3769

Large. Tip length 4.7mm.



Custom etching

Custom etching is available on stainless steel surgical instruments on new orders as they are purchased. Ask your customer support representative at **800.323.9088** for more information.

Dissecteurs Jannetta/Forceps/Crochets/Sondes
 Jannetta-Dissektoren/Zangen/Haken/Sonden
 Dissettori Jannetta/Pinze/Uncini/Sonde
 Diseccionadores Jannetta/Fórceps/Ganchos/Sondas
 Escalpelos Jannetta/Fórceps/Ganchos/Sondas
 Jannetta切開器/鉗子/フック/プローブ

JANNETTA Probe

Small. Tip length 1.7mm.
 Angled 45°.



NL3767

Overall length
 7-1/2in (19.1cm).



JANNETTA Hook

Medium. Tip length 2.8mm.
 Angled 45°.



NL3768-001

Overall length
 7-1/2in (19.1cm).



JACOBSON-Type Probe

0.7mm diameter ball tip.
 Tip length 10mm.



NL3770

Overall length
 7-1/2in (19.1cm).



JANNETTA Double Prong Forks

Angled 30°. Overall length
 7-1/2in (19.1cm).

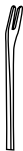

NL3771

Small. 1.3mm wide.

NL3772

Large. 2mm wide.



JANNETTA Aneurysm Neck Dissectors

Ligature carrier. Suture hole in blade.
 Overall length 7-1/2in (19.1cm).



NL3773

Right.

NL3774

Left.



JANNETTA Forceps

Bayonet. Overall length
 6-1/4in (15.9cm).



NL3776

Fine, smooth points.

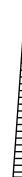

NL3777

Fine, serrated points.



Kennerdell-Maroon Retractors

Écarteurs Kennerdell-Maroon
Kennerdell-Maroon-Reraktoren
Divaricatori Kennerdell-Maroon
Separadores Kennerdell-Maroon
Retratores Kennerdell-Maroon
Kennerdell-Maroon リトラクター

KENNERDELL-MAROON Orbital Retractor Set

Self-retaining, versatile in adaptability,
designed for greater exposure.

NL1175

Includes the following:

- NL1175-001 One Retractor Frame with three posts.
 - NL1175-002 Four Round Extension Rods, length 3-3/4in (9.5cm).
 - NL1175-003 Five Universal Swivel Connectors.
 - NL1175-004 Two Blades, 50mm x 5mm wide. Malleable. Copper.
 - NL1175-005 Three Blades, 50mm x 8mm wide. Malleable. Copper.
 - NL1175-006 Three Blades, 50mm x 15mm wide. Malleable. Copper.
- Individual parts are also available as needed.



Round Extension Rod

NL1175-002

Overall length
3-3/4in (9.5cm).



Universal Swivel Connector

NL1175-003



KENNERDELL-MAROON Orbital Retractor Blades

NL1175-004

50mm x 5mm wide.

NL1175-005

50mm x 8mm wide.

NL1175-006

50mm x 15mm wide.



KENNERDELL-MAROON Dissector

Round.
Diameter 2.5mm.

NL1176-001

Mirror and Satin finish.



Ciseaux Yasargil
Yasargil-Schere
Forbici Yasargil
Tijeras Yasargil
Tesoura Yasargil
Yasargil 鉗

YASARGIL Round Tip Micro Scissors

Straight.

NL3160

Overall length
6-1/4in (15.9cm).



YASARGIL Round Tip Micro Scissors

Bayonet shape, straight blades.

NL3162-010

Working length
3-7/8in (9.8cm).
Overall length
7-1/2in (19.1cm).

NL3162-012

Working length
4-3/4in (12cm).
Overall length
8-1/4in (21cm).



YASARGIL Micro Scissors

Bayonet shaped.

NL4000

Straight.
Blade length 11.5mm.
Overall length 6-1/2in (16.5cm).

NL4001

Curved upward.
Blade length 11mm.
Overall length
6-1/2in (16.5cm).

NL4003

Straight.
Blade length 12.5mm.
Overall length 8in (20.3cm).

NL4004

Curved upward.
Blade length 12mm.
Overall length 8in (20.3cm).

NL4002

Curved downward.
Blade length 12mm.
Overall length 8in (20.3cm).



YASARGIL Micro Scissors

NL4006

Tapered tip, curved upward.
Blade length 12.5mm.
Overall length
8-3/4in (22.2cm).

NL4007

Straight.
Blade length 16.5mm.
Overall length
8-3/4in (22.2cm).

NL4008

Curved upward.
Blade length 16.5mm.
Overall length
8-3/4in (22.2cm).



YASARGIL Bayonet Scissors

NL3152

Straight blades.
Overall length
7-1/4in (18.4cm).

NL3152-002

Curved blades.
Overall length
7-1/4in (18.4cm).

NL3152-001

Extra-fine straight blades.
Overall length
8-3/4in (22.2cm).



YASARGIL Bayonet Scissors

Overall length
7-1/2in (19.1cm).

NL3062

Straight blades.

NL3065

Blades angled sideward.



Yasargil Forceps/Knives

Forceps Yasargil/Couteaux
 Yasargil-Zange/Messer
 Pinza Yasargil/Bisturi
 Fórceps Yasargil/Cuchillos
 Fórceps Yasargil/Facas
 Yasargil 鉗子/ナイフ

YASARGIL Forceps

Bayonet. Smooth jaws.



NL3138

Overall length
 7-1/2in (19.1cm).



YASARGIL Forceps

Bayonet. 1 x 2 teeth.



NL3139

Overall length
 8in (20.3cm).



YASARGIL Scoop

Bayonet shank with round handle.



NL3075

Overall length
 7-1/4in (18.4cm).



YASARGIL Arachnoid Knives

Bayonet shank with round handle.
 Mirror and Satin finish.
 Overall length
 7-1/4in (18.4cm).

NL3079

Blade curved backward.



NL3080

Blade curved forward.



YASARGIL Raspatory

Rounded blade. Slightly curved.



NL3091

Overall length
 7-1/4in (18.4cm).



YASARGIL Tissue Lifter

1mm diameter.

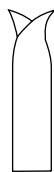

NL3093

Overall length
 7-1/4in (18.4cm).



YASARGIL Ligature Guide and Carriers

Probe pointed.
 Overall length
 7-1/4in (18.4cm).

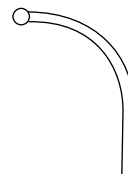

NL3106

1/2 curved.

NL3107

5/8 curved.

NL3108

3/4 curved.

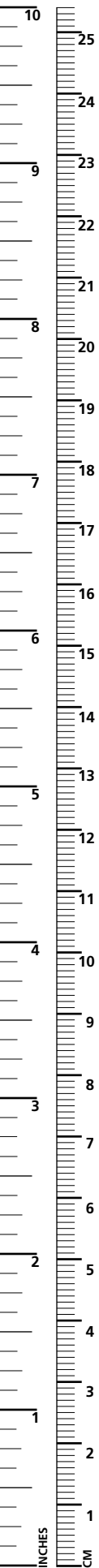

Curettes de Hardy/Instruments Marino
 Hardy-Küretten/Marino-Instrumente
 Curette Hardy/Strumenti Marino
 Curetas Hardy/Instrumentos Marino
 Curetas Hardy/Instrumentos Marino
 頑強なキュレット/Marino器具

HARDY Curettes

Bayonet. Working length 4-3/4in (12cm).
 Overall length 9-1/2in (24.1cm).

NL5395-001

Angled up, 3mm.

NL5395-002

Angled up, 5mm.

NL5395-003

Angled down, 3mm.

NL5395-004

Angled down, 5mm.

NL5395-005

Angled 90° left, 3mm.

NL5395-006

Angled 90° left, 5mm.

NL5395-007

Angled 45° right, 3mm.

NL5395-008

Angled 45° right, 5mm.

NL5395-010

Curved right, 5mm.

NL5395-009

Curved left, 5mm.



HARDY Dissector

Sharp inner edge.
 Turned downward
 on bayonet handle.



NL3853-003

Overall length
 8-1/2in (21.6cm).



**MARINO Rotatable
 Transsphenoidal
 Knife Handle**

NL5901

Working length 4-1/8in
 (10.5cm). Overall length
 9-1/8in (23.2cm)



**MARINO Rotatable
 Transsphenoidal
 Enucleator**

Working length
 5-3/8in (13.7cm).
 Overall length
 10-1/2in (26.7cm).

NL5902

Small, right.
 Tip 3mm wide.

NL5903

Small, left.
 Tip 3mm wide.

NL5904

Regular, right.
 Tip 3.8mm wide.

NL5905

Regular, left.
 Tip 3.8mm wide.



**MARINO Rotatable
 Transsphenoidal
 Round Dissector**

Sharp. Mirror and Satin finish.

NL5906

Working length
 5-3/8in (13.7cm).
 Overall length
 10-1/2in (26.7cm).



**MARINO Rotatable
 Transsphenoidal
 Spatula Dissector**

NL5907

Working length
 5-3/8in (13.7cm).
 Overall length
 10-1/2in (26.7cm).



**MARINO Rotatable
 Transsphenoidal
 Right Angle Hook**

Mirror and Satin finish.

NL5908

Working length
 5-3/8in (13.7cm).
 Overall length
 10-1/2in (26.7cm).



Instruments Marino/Pieds à coulisse
 Marino-Instrumente/Messschieber
 Strumenti Marino/Estesiometri
 Instrumentos Marino/Calibres
 Instrumentos Marino/Pinças
 Marino器具/キャリパー

MARINO Rotatable Transsphenoidal Vertical Ring Curette

Ring diameter 3mm.

NL5909

Working length
 5-3/8in (13.7cm).
 Overall length
 10-1/2in (26.7cm).



MARINO Rotatable Transsphenoidal Horizontal Ring Curette

Working length
 5-3/8in (13.7cm).
 Overall length
 10-1/2in (26.7cm).

NL5910

Ring diameter 3mm.

NL5911

Ring diameter 6mm.



MARINO Rotatable Transsphenoidal 45° Horizontal Ring Curette

Ring diameter 5mm.

NL5912

Working length
 5-3/8in (13.7cm).
 Overall length
 10-1/2in (26.7cm).



MARINO Rotatable Transsphenoidal Vertical Ring Curette

Curved shaft, 5mm.

NL5913

Working length
 5-3/8in (13.7cm).
 Overall length
 10-1/2 in (26.7cm).



WARTENBERG Pinwheel

NL4300

Overall length
 7-3/8in (18.7cm).



CASPER-Style Caliper

NL8100



Customer Support

Our highly trained, centralized V. Mueller customer support team is available to take your calls from 7:00 a.m. to 6:00 p.m. (CST), M-F. This group is dedicated to providing a full range of support services, including:

- Order placement
- Order inquiries
- Delivery information
- Product information
- Pricing inquiries

If we can be of assistance, please call us at **800.323.9088**.

Neuro/Spine and Orthopedic Instruments

Retractors, Osteotomes, Currettes and
Rongeur Forceps

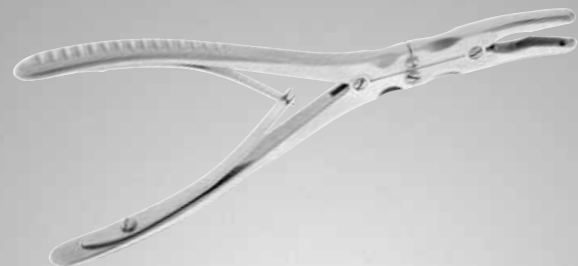
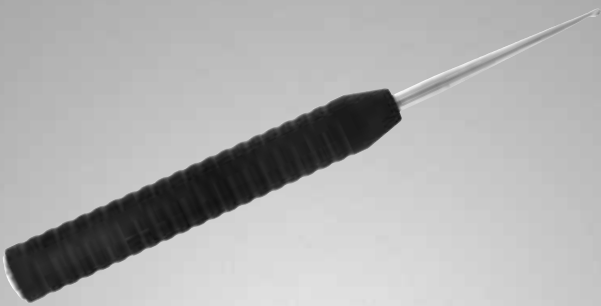

Retractors

Écarteurs
Wundspreizer/Retraktoren
Divaricatori
Separadores
Retratores
リトラクター

RAGNELL Retractor

Delicate,
double-ended.
Blades 3mm x 6.3mm
and 6.3mm x 16mm.

◆ **OS930**
Overall length
6in (15.2cm).



KLEINERT-RAGNELL Retractor

Double-ended.

◆ **OS1182**
Overall length
6in (15.2cm).



KASDEN Thin Blade Retractor

Double-ended.

OS2471
Overall length
6-1/4in (15.9cm).



BROWNE Retractors

Overall length
10-7/8in (27.5cm).

OS4148
Blades
40mm x 50mm wide.

OS4149
Blades
60mm x 65mm wide.



HAYES Hand Retractor

Distal tip 6mm wide.

OS4158
Overall length
6in (15.2cm).



HOHMANN Retractor

Blade 16mm wide.

OS4160-007
Overall length
4-3/4in (12.1cm).



HOHMANN Retractor

Blade 15mm wide.

OS4160-001
Overall length
6in (15.2cm).



HOHMANN Retractors

Short tip. Overall length
6-1/4in (15.9cm).

OS4160-002
Blade 6mm wide.

OS4160-003
Blade 8mm wide.



HOHMANN Retractor

Overall length
6-1/2in (16.5cm).

OS4160-008

Blade 15mm wide.



HOHMANN Retractors

Overall length
8-3/4in (22.2cm).

OS4160-009

Blade 8mm wide.

OS4160-010

Blade 10mm wide.



HOHMANN Retractor

Overall length
10-3/4in (27.3cm).

◆ **OS4160-011**

Blade 24mm wide.



HOHMANN Retractor

Blade 22mm wide.
Curved 120°.

OS4160-012

Overall length
16in (40.6cm).



HOHMANN Retractors

◆ **OS4160-004**
Blade 18mm wide.
Overall length
9-1/4in (23.5cm).

OS4160-005
Blade 44mm wide.
Overall length
9-1/2in (24.1cm).

OS4160-006
Blade 70mm wide.
Overall length
9-1/2in (24.1cm).



HOHMANN Retractor

Blade 40mm wide.
Curved 90°.

OS4160-013

Overall length
13in (33cm).

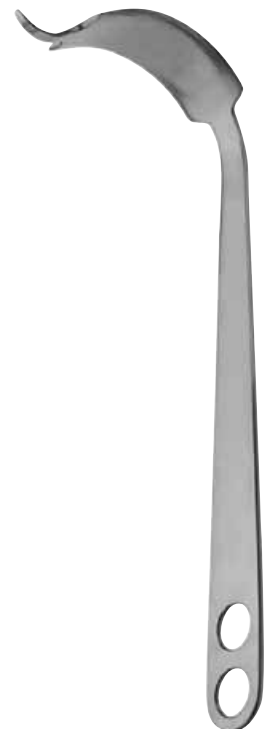

Retractors

Écarteurs
Wundspreizer/Retraktoren
Divaricatori
Separadores
Retratores
リトラクター

BRISTOW-BANKART Soft Tissue Retractor

Blade 2.1cm wide.

OS4144

Overall length
8-3/4in (22.2cm).



Pelvic Retractor

Single prong.
Blade 24mm wide.

OS4156

Overall length
10-3/4in (27.3cm).



AUFRANC Cobra Retractors

Hollow handle. Maximum blade width
1-1/4in (3.2cm).
Overall length
10in (25.4cm).



◆ **OS4141**

Smooth blunt tip.



OS4142

Smooth pointed tip.

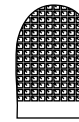

OS4143

Serrated blunt tip.



DOANE Knee Retractors

Double-ended.



◆ **OS4135**

Medium.
Blade 5.7cm and 7.5cm deep,
15.2cm long, 1.1cm wide.

OS4136

Large.
Blade 6.6cm and 8cm deep,
15.2cm long, 1.1cm wide.

MORREY Elbow Retractors

Double-ended.

OS3500

Set includes 1 each
OS3500-001 (large/medium)
and OS3500-002
(small/medium).

OS3500-001

Large/Medium.
Overall length
12.5in (31cm).

OS3500-002

Small/Medium.
Overall length
11in (27.5cm).



BRISTOW-BANKART Humeral Retractor



OS4140

Blade 2.5cm wide, 10.2cm deep.

Écarteurs
Wundspreizer/Retraktoren
Divaricatori
Separadores
Retratores
リトラクター

Ligament Retractors

OS4152-29

Medium.
Overall length
11-1/2in (29cm).

OS4152-38

Long.
Overall length
15in (38cm).



CHANDLER Retractors

Overall
length
8-1/2in
(21.5cm).

OS4153-16

Blade 15.9mm wide.

OS4153-19

Blade 19.1mm wide.



Humeral Head Retractor

Blade 18mm wide.

OS4145

Overall length
8-1/2in (21.6cm).



MURPHY-LANE Bone Skid

OS4030

Overall length
12in (30.5cm).



BENNETT Bone Elevators and Retractors

Overall
length
9-3/4in
(24.8cm).

OS4130-001

Small blade.
Blade 1-3/4in
(44mm) wide.

OS4130-002

Large blade.
Blade 2-1/2in
(64mm) wide.



BLOUNT Retractor

Overall length 10-1/2in (26.7cm).

OS926

Double prong.
Blade 44mm wide.



BLOUNT Retractor

Overall length
10-1/2in (26.7cm).

OS927

Single prong.
Blade 37mm wide.



BLOUNT Knee Retractor

Overall length 7in (17.8cm).

OS928

6mm tip.



Retractors

Écarteurs
Wundspreizer/Retraktoren
Divaricatori
Separadores
Retratores
リトラクター

SMILLIE Knee Retractor

Overall length 5-1/2in (14cm).

OS4040

Straight.
Blade 19mm x 30mm wide.

OS4041

Straight.
Blade 19mm x 45mm wide.

OS4042

Straight.
Blade 19mm x 60mm wide.

OS4043

Curved.
Blade 13mm x 18mm wide.

OS4044

Reverse curve.
Blade 13mm x 55mm wide.



Angulated T-Handle Retractors

5in (12.7cm) deep blade.

OS4070

Shaft length 7in (17.8cm).

OS4075

Shaft length 11in (27.9cm).



T-Handle Bone Hook

Overall length 7in (17.8cm).

OS4081

Sharp.



FUKUDA-STYLE Shoulder Retractors

Overall length
7in (17.8cm).
Blade 32mm x
81mm wide.

OS4146-32

Straight.

OS4146-38

Slight curve.

OS4147-32

Full curve.

OS4147-38

Reverse curve.



Capsule Retractors

Overall length 10in (25.4cm).

OS4151-1

1 prong. 20mm wide.

OS4151-2

2 prongs. 20mm wide.

OS4151-3

3 prongs. 22mm wide.



Looking for a specific product?

When you know the catalog number or the name of the product you need, you can use the index at the end of this book to direct you to the page on which the product is described. If you do not find the specific instruments you are looking for, please contact your local V. Mueller sales representative or Customer Support at **800.323.9088**.

Écarteurs
Wundspreizer/Retraktoren
Divaricatori
Separadores
Retradores
リトラクター

SOFIELD Retractor

Double-ended. Mirror and Satin finish.

OS925

Set of 6 with clip.

Includes 1 each of the following sizes:

Part No.	Description
OS925-001	Blade length 6.3cm x 1.3cm and 3.8cm x 1.3cm.
OS925-002	Blade length 7cm x 1.3cm and 4.4cm x 1.3cm.
OS925-003	Blade length 8.3cm x 1.6cm and 5.1cm x 1.6cm.
OS925-004	Blade length 8.9cm x 1.6cm and 5.7cm x 1.6cm.
OS925-005	Blade length 10.2cm x 1.9cm and 7cm x 1.9cm.
OS925-006	Blade length 11.4cm x 1.9cm and 7.6cm x 1.9cm.

**CLOWARD-Style Muscle Retractor**

Short blade.

NL5105

Overall length 7-3/4in (19.7cm).
6.4mm x 9.5mm.

**CLOWARD-Style Blade Retractors**

Overall length 7in (17.8cm).

NL5103-13C

Blade 13mm x 70mm wide.

NL510313NL

Without lip. Blade 13mm x 70mm wide.

NL5103-18C

Blade 18mm x 75mm wide.

NL510318NL

Without lip. Blade 18mm x 75mm wide.

NL5103-20C

Blade 20mm wide x 75mm wide.

NL510320NL

Without lip. Blade 20mm x 75mm wide.

NL5103-23C

Blade 23mm wide x 75mm wide.

**CLOWARD-Style Blade Retractors**

Overall length 7-1/2in (19.1cm).

NL5104-13

Blade 13mm x 70mm wide.

NL510418NL

Without lip. Blade 18mm x 75mm wide.

NL510420NL

Without lip. Blade 20mm x 75mm wide.

NL5104-23

Blade 23mm x 75mm wide.

NL5103-23NL

Without lip. Blade 23mm x 75mm wide.



Retractors

Écarteurs
Wundspreizer/Retraktoren
Divaricatori
Separadores
Retratores
リトラクター

HIBBS Retractors

Overall length 9-1/8in (23.2cm).

NL5100

Blade 1in x 3in (2.5cm x 7.6cm) wide.

NL5101

Blade 3/4in x 2in (1.9cm x 5.1cm) wide.

NL5102

Blade 1/2in x 1in (1.3cm x 2.5cm) wide.

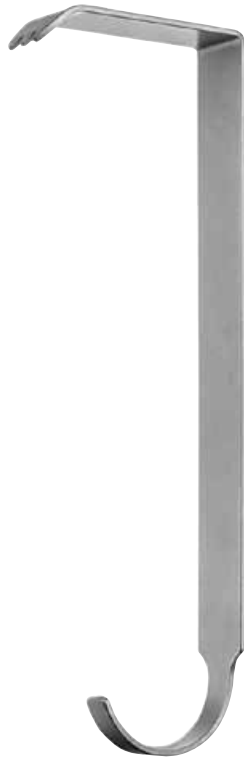

MEYERDING Retractors

Sharp-toothed edge holds tissue for fullest exposure.

NL5130

Blade 2in x 3-1/2in
(5.1cm x 8.9cm) wide.
Overall length
9-1/2in (24.1cm).

◆ NL5131

Blade 1in x 3in
(2.5cm x 7.6cm) wide.
Overall length
9-1/4in (23.5cm).

NL5132

Blade 5/8in x 2in
(1.6cm x 5.1cm) wide.
Overall length
8-1/2in (21.6cm).



COLLIS TAYLOR Retractors

Regular width. 3.2cm wide. Overall length 7-1/4in (18.4cm).

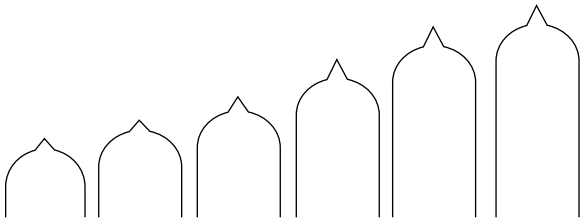

NL9401

Set of 6 blade lengths with sterilizing case.
Includes 1 each of the following:

Part No.	Description
NL9401-001	Blade length 1-1/2in (3.8cm).
NL9401-002	Blade length 2in (5.2cm).
NL9401-003	Blade length 2-1/2in (6.5cm).
NL9401-004	Blade length 3in (7.6cm).
NL9401-005	Blade length 3-1/2in (8.9cm).
NL9401-006	Blade length 4in (10.2cm).
NL9404	Sterilizing case.

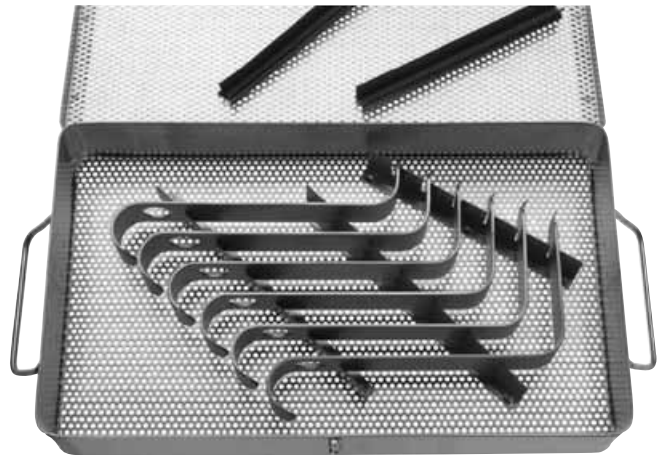

COLLIS TAYLOR Retractors

Micro width. 3.1cm wide. Overall length 7-1/4in (18.4cm).

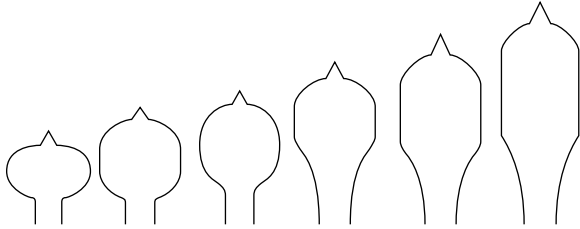
**NL9402**Set of 6 blade lengths with sterilizing case.
Includes 1 each of the following:

Part No.	Description
NL9402-001	Blade length 1-1/2in (3.8cm).
NL9402-002	Blade length 2in (5.1cm).
NL9402-003	Blade length 2-1/2in (6.4cm).
NL9402-004	Blade length 3in (7.6cm).
NL9402-005	Blade length 3-1/2in (8.9cm).
NL9402-006	Blade length 4in (10.2cm).
NL9404	Sterilizing Case.

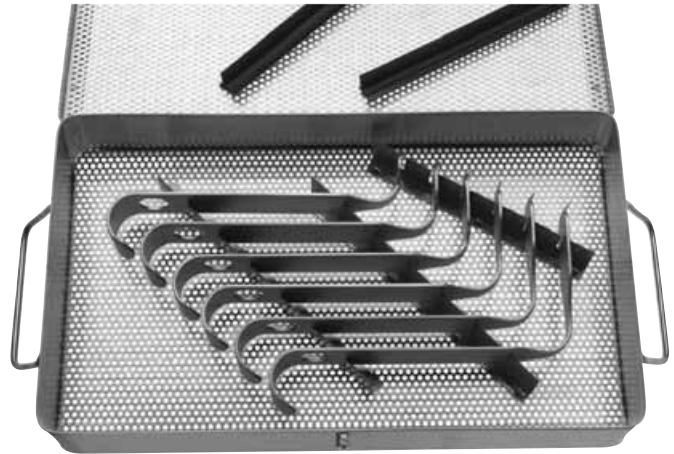
**COLLIS TAYLOR Retractors**

Narrow width. 2.2cm wide. Overall length 7-1/4in (18.4cm).

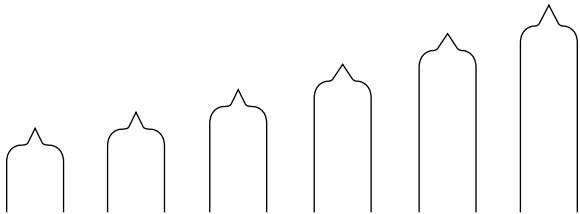
**NL9403**Set of 6 blade lengths with sterilizing case.
Includes 1 each of the following:

Part No.	Description
NL9403-001	Blade length 1-1/2in (3.8cm).
NL9403-002	Blade length 2in (5.1cm).
NL9403-003	Blade length 2-1/2in (6.4cm).
NL9403-004	Blade length 3in (7.6cm).
NL9403-005	Blade length 3-1/2in (8.9cm).
NL9403-006	Blade length 4in (10.2cm).
NL9405	Sterilizing case.

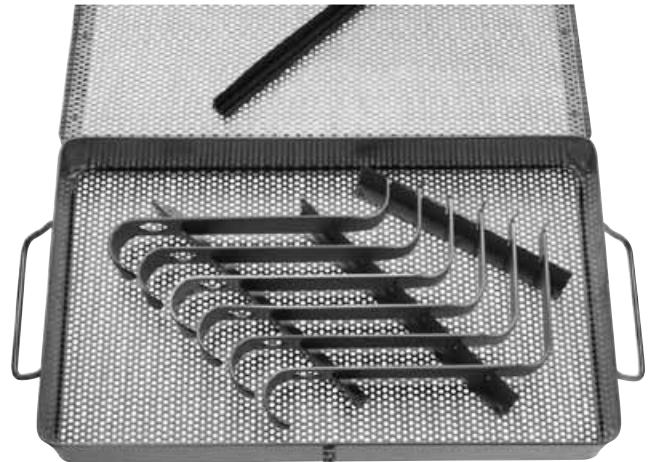

Retractors

Écarteurs
Wundspreizer/Retraktoren
Divaricatori
Separadores
Retratores
リトラクター

SELETZ-GELPI Retractor

Modified, with long curve in shanks.
Ratchet lock.

◆ **NL5380**

Overall length
7in (17.8cm).



ZELPI-Type Retractors

Angled 90°. 5in (12.7cm) maximum spread.
Overall length 10-1/4in (26cm).

NL5381-3

3in (7.6cm) deep arms.

NL5381-4

4in (10.2cm) deep arms.

NL5381-5

5in (12.7cm) deep arms.



BECKMAN Retractors

Hinged arms. 3 x 4 prongs.

SU3191

Blunt.
Overall length
5-1/2in (14cm).

SU3192

Blunt.
Overall length
6-1/2in (16.5cm).

SU3194

Sharp.
Overall length
5-1/2in (14cm).

SU3196

Sharp.
Overall length
8-1/2in (21.6cm).



V. Mueller Instrument Detergents

To assist with the care and handling of your instruments, CareFusion offers you a full line of cleaning and decontamination products detailed in the Genesis Sterilization Containers and Instrument Processing Supplies section of this armamentarium.

Écarteurs/Larmes d'écarteur
 Wundspreizer/Retraktoren/Wundspreizerblätter
 Divaricatori/Lame divaricatore
 Separadores/Cuchillas de separadores
 Retratores/Láminas de retrator
 リトラクター/リトラクターのブレード

Initial Incision Retractor Set

OS6001

Set includes two 2in (5cm) blades, frame, and 3lb weight with chain.
 OS6010-012 Short blades. (2 each)
 OS6000-001 Frame. (1 each)
 OS6000-002 3lb weight on chain. (1 each)

Large Initial Self-Retaining Retractor

OS6000

Frame 7-1/2in x 10-1/2in (19cm x 26.5cm).
 Adjustable blades 2.5cm x 2.5cm.
 Weight 3 lb.

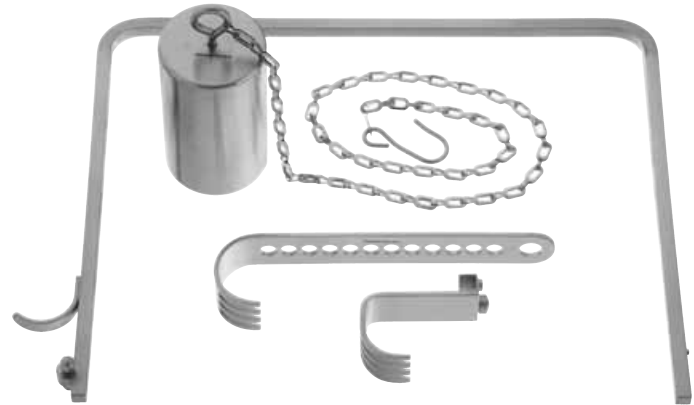

Deep Initial Incision Retractor Set

OS6002

Set includes two 4in (10.2cm) blades, frame, and 3lb weight with chain.
 OS6010-017 Long blades. (2 each)
 OS6000-001 Frame. (1 each)
 OS6000-002 3lb weight on chain. (1 each)

Incision Retractor Set Components

OS6000-001

Frame only. 7-1/2in x 10-1/2in (19cm x 26.5cm).

OS6000-002

3lb weight on chain.

OS6000-003

Chain.

Incision Retractor Blade Set

OS6000-004

Deep blades.
 Includes two
 4in (10.2cm) blades.

OS6000-005

Includes two
 2in (5.12cm) blades.

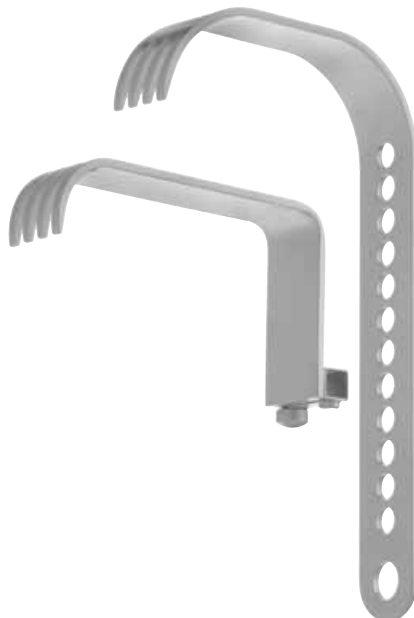

Short Incision Blades

Single blade only.

OS6010-010

1in x 1in (2.5cm x 2.5cm).

OS6010-011

1in x 1-1/2in (2.5cm x 3.8cm).

OS6010-012

1in x 2in (2.5cm x 5.0cm).

OS6010-013

1in x 2-1/4in (2.5cm x 5.7cm).

OS6010-014

1in x 2-1/2in (2.5cm x 6.3cm).

OS6010-016

1in x 3in (2.5cm x 7.5cm).

OS6010-017

1in x 4in (2.5cm x 10.0cm).

OS6010-019

1in x 5in (2.5cm x 12.7cm).



Retractor Blades/Hooks

Larmes d'écarteur/Crochets
Wundspreizerblätter/Haken
Lame divaricatore/Uncini
Cuchillas de separadores/Ganchos
Lâminas de retrator/Ganchos
リトラクターのブレード/フック

Long Incision Blades

Single blade only.

OS6020-010

1 in x 1 in (2.5cm x 2.5cm).

OS6020-011

1 in x 1-1/2 in (2.5cm x 3.8cm).

OS6020-012

1 in x 2 in (2.5cm x 5.0cm).

OS6020-013

1 in x 2-1/4 in (2.5cm x 5.7cm).

OS6020-014

1 in x 2-1/2 in (2.5cm x 6.3cm).

OS6020-016

1 in x 3 in (2.5cm x 7.5cm).

OS6020-017

1 in x 4 in (2.5cm x 10.0cm).

OS6020-018

1 in x 4-1/2 in (2.5cm x 11.4cm).

OS6020-019

1 in x 5 in (2.5cm x 12.7cm).

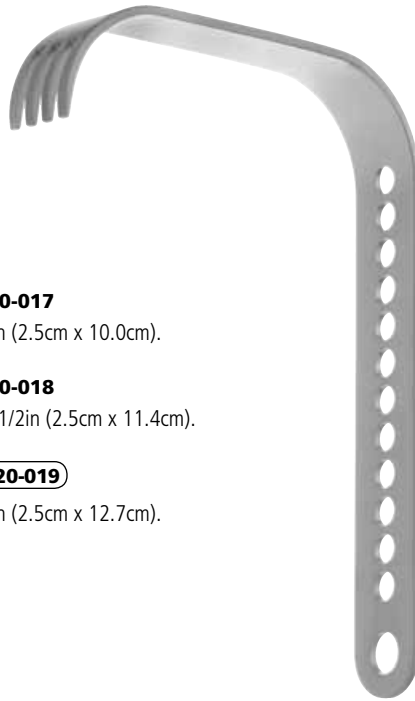

BOYES-GOODFELLOW Hook

Modified points.

OS5500

Overall length
8-1/4 in (21cm).



Customer Support

Our highly trained, centralized V. Mueller customer support team is available to take your calls from 7:00 a.m. to 6:00 p.m. (CST), M-F. This group is dedicated to providing a full range of support services, including:

- Order placement
- Order inquiries
- Delivery information
- Product information
- Pricing inquiries

If we can be of assistance, please call us at **800.323.9088**.

Crochets/Mains de plomb/Forceps
 Haken/Lead Hands/Zangen
 Uncini/Stecche per la mano/Pinze
 Ganchos/Manos de plomo/Fórceps
 Ganchos/Suportes manuais/Fórceps
 フック/リードハンド/鉗子

Bone Hooks

Heavy model.
 Overall length 9in (22.9cm).

OS4080-001

Sharp.
 Hook diameter 3/4in (1.9cm).

OS4080-002

Blunt.
 Hook diameter 3/4in (1.9cm).

OS4080-004

Sharp.
 Hook diameter 1in (2.5cm).

OS4080-003

Sharp.
 Hook diameter
 1-3/16in (3cm).



GILLIES Bone and Zygoma Hook

Diameter 9mm.

RH2736

Overall length
 7-3/8in (18.7cm).



Lead Hands

Malleable.

OS5002

Small.

◆ **OS5003**
 Large.



Lead Hand

Malleable.
 Made with Tin.

◆ **OS5004**

Overall length
 12in (30.5cm).



LEWIN Spinal Perforating Forceps

Jaws extend from shanks in curve.

◆ **NL6960**

Overall length
 7in (17.8cm).



CHANDLER Spinal Perforating Forceps

Jaws extend in line with shanks.

NL6970

Overall length
 7in (17.8cm).



Bone Holding Forceps

Daviers porte-os
Knochenhaltezange
Pinze portaossa
Fórceps de sostén del hueso
Pinça para fixação óssea
骨固定鉗子

KERN Bone Holding Forceps

OS910-008

With folding ratchet.
Small. Overall length
5-1/2in (14cm).

OS910-006

With folding ratchet.
Overall length
8-1/2in (21.6cm).

OS910-009

Without ratchet.
Overall length
5-3/4in (14.6cm).

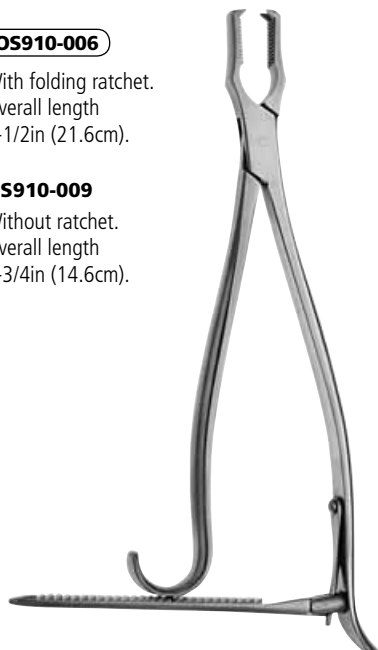

LANE Bone Holding Forceps

OS910-003

With ratchet.
Overall length
13in (33cm).

OS910-003H

With ratchet.
Heavy model.
Overall length
13in (33cm).

OS910-004

With ratchet.
Overall length
17in (43.2cm).

OS910-001

Without ratchet.
Light model.
Overall length
13in (33cm).

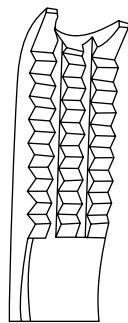

OS910-001H

Without ratchet.
Heavy model.
Overall length
13in (33cm).

OS910-002

Without ratchet.
Overall length
17in (43.2cm).



LAMBOTTE Bone Holding Forceps

Adjustable.

OS915

Overall length
8-1/2in (21.6cm).



FARABEU-F-LAMBOTTE Bone Holding Forceps

Adjustable.

OS4835

Overall length
10in (25.4cm).



BISHOP Bone Holding Forceps

Adjustable.

OS4830

Overall length
9in (23cm).



Daviers porte-os/Clamps
Knochenhaltezeange/Klemmen
Pinze portaossa/Morse
Fórceps de sostén del hueso/Pinzas
Pinça para fixação óssea/Pinças
骨固定鉗子/クランプ

Bone Forceps

Self-centering. Extra-small serrated jaw, length 10mm.

OS910-010

Size 0.
Overall length
6-3/4in (17.1cm).



ULRICH Bone Holding Forceps

Quick-speed positive locking nut for easy adjustment.

OS910-012

Small size.
Overall length
8-3/4in (22.2cm).

OS910-013

Medium size.
Overall length
9-1/2in (24.1cm).



ULRICH Small Bone Holding Forceps

Self-retaining. Dual locking nuts prevent further closing of jaws after tightening. Narrow, straight style.

OS910-025

Overall length
7-1/4in (18.4cm).



ULRICH Bone Holding Forceps

1 serrated jaw swiveled, the other a double prong.

OS910-027

Overall length
9-1/2in (24.1cm).



LOWMAN Bone Holding Clamps

1 x 2 prong jaws.

◆ **OS910-030**

Small size.
Overall length
4-3/4in (12.1cm).

OS910-031

Medium size.
Overall length
7in (17.8cm).

OS910-034

Large size.
Overall length
8-1/4in (20.8cm).



For more than 115 years, the V. Mueller® name has been known worldwide as a leading developer, manufacturer and provider of high-quality surgical instruments. As part of CareFusion, V. Mueller® instrumentation continues to offer innovative surgical instruments, including a broad selection of laparoscopic instruments to satisfy your minimally invasive surgical instrument needs.

Bone Holding Forceps/Clamps

Daviers porte-os/Clamps
Knochenhaltezeuge/Klemmen
Pinze portaossa/Morse
Fórceps de sostén del hueso/Pinzas
Pinça para fixação óssea/Pinças
骨固定鉗子/クランプ

LAMBERT-LOWMAN Bone Clamp

2 x 2 jaws, 1-3/8in (3.5cm) wide.

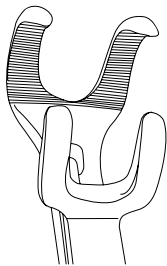

OS910-038

Overall length
8in (20.3cm).



DINGMAN Bone Holding Forceps

Overall length
7-1/4in (18.4cm).

OS4800

Small,
narrow jaws.

OS4802

Large jaws.



DINGMAN Bone Holding Forceps

Large jaws.
Slot in 1 jaw
0.3cm wide.

OS4803

Overall length
7-1/4in (18.4cm).



LANGENBECK Bone Holding Forceps

2 x 2 teeth.

OS4825

Overall length
8-1/4in (21cm).



FERGUSON Bone Holding Forceps

OS4820

Overall length
8-1/4in (21cm).



Daviers porte-os/Clamps
Knochenhaltezeange/Klemmen
Pinze portaossa/Morse
Fórceps de sostén del hueso/Pinças
Pinça para fixação óssea/Pinças
骨固定鉗子/クランプ

FARABEUF Bone Holding Forceps

Adjustable.

OS4840-002

Overall length
10-1/2in (26.7cm).



VERBRUGGE Bone Holding Forceps

Ratchet.

OS910-060

Overall length
6-3/4in (17.1cm).



VERBRUGGE Bone Holding Forceps

Speed lock.

OS910-050

Overall length
6in (15.2cm).

OS910-051

Overall length
9-1/2in (24.1cm).

◆ **OS910-053**

Overall length
10in (25.4cm).

OS910-054

Overall length
11in (27.9cm).



VERBRUGGE Bone Holding Forceps

Long ratchet.

OS910-040

Overall length
10in (25.4cm).

OS910-041

Overall length
10-1/2in (26.7cm).

OS910-042

Overall length
11in (27.9cm).

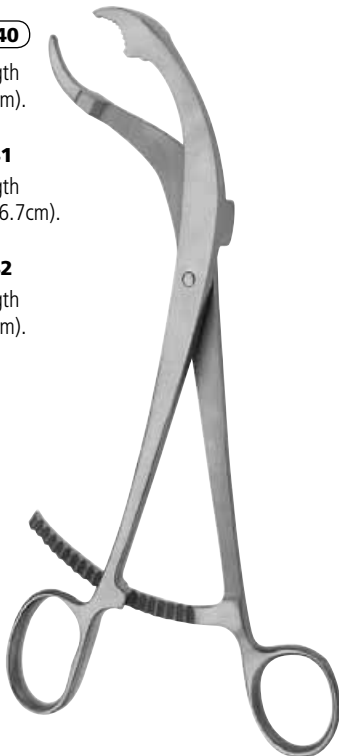

LOCKE Phalangeal Forceps

1 x 2 teeth. Serrated.



OS4805

Overall length
6in (15.2cm).



Small Bone Clamp

Slight curve.

OS4828

Overall length
6-1/2in (16.5cm).



Forceps

Forceps
Zangen
Pinze
Fórcps
Fórcps
鉗子

Fibula Forceps

Speed lock.

OS913

Overall length
8-1/4in (21cm).



PATELLA Forceps

Speed lock.

OS4827

Overall length
7-1/4in (18.4cm).



Reduction Forceps

OS911-003

Ratchet.
Serrated jaw.
Overall length
5-1/2in (14cm).

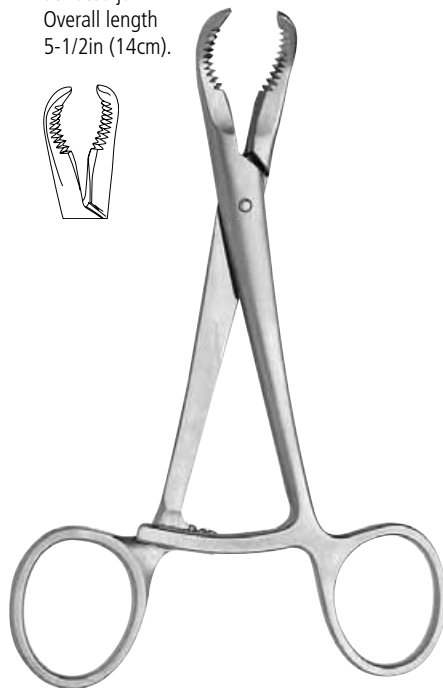

Bone Reduction Forceps

OS911-009

Ratchet.
Pointed jaw with step.
Overall length
6-3/4in (17.1cm).

OS911-006

Ratchet.
Pointed jaw.
Overall length
8in (20.3cm).

OS911-005

Speed lock.
Pointed jaw.
Overall length
8in (20.3cm).



Bone Reduction Forceps

Ratchet. Serrated with pointed jaw.

OS912-001

Overall length
5in (12.7cm).

OS912-002

Overall length
5-1/2in (14cm).



Bone Reduction Forceps

Ratchet. Pointed jaw.

OS911-007

Overall length
7in (17.8cm).



Forceps/Élévateurs
Zangen/Heber
Pinze/Elevatori
Fórceps/Elevadores
Fórceps/Elevadores
鉗子/エレベーター

Bone Reduction Forceps

◆ **OS911-010**

Ratchet. Pointed jaw.
Overall length
8in (20.3cm).



Reduction Forceps

OS911-012

Small serrated jaw.
Overall length
7in (17.8cm).



◆ **OS911-013**

Large serrated jaw.
Overall length
9in (23cm).

Pelvic Reduction Forceps

OS920

1 x 2 jaws.
Overall length
16in (40.6cm).



Pelvic Reduction Forceps

OS921

Overall length
10in (25.4cm).



OS922

Overall length
16in (40.6cm).

Pelvic Reduction Forceps

Asymmetric.

OS923

Overall length
16in (40.6cm).



Metatarsal Elevators

Overall length 6-1/2in (16.5cm).

OS1088-011

Blade 11mm wide.

OS1088-013

Blade 13mm wide.

OS1088-015

Blade 15mm wide.

OS1088-017

Blade 17mm wide.



Elevators

Élévateurs
Heber
Elevatori
Elevadores
Elevadores
エレベーター

MOLT Elevator

Double-ended.
Slightly curved,
round end.

OS1086-001

Overall length
7in (17.8cm).



CUSHING Elevator

Small. Blunt blade,
6mm wide.

NL1073

Overall length
7-1/4in (18.4cm).



CUSHING Elevator

Narrow. Sharp blade,
8mm wide.

NL1074

Overall length
7-3/4in (19.7cm).



CUSHING Elevators

Wide, sharp end.
Overall length
7-1/2in (19.1cm).

NL1060

Round edge.
Overall length
7-1/2in (19.1cm).



NL1062

Round edge
on "S" curved shank.
Overall length
7-1/2in (19.1cm).

NL1064

Square edge.
Overall length
7-1/2in (19.1cm).

CUSHING Elevator

Wide, sharp.
Blade 15mm wide.

NL1075

Overall length
7-1/2in (19.1cm).



CUSHING Staphylorrhaphy Elevator

Blade 6mm wide.

NL1072

Overall length
8in (20.3cm).



WOODSON Dural Separator and Packer

Double-ended.
Blade 13mm x
3mm wide.

NL2820

Overall length
6-3/4in (17.1cm).



WOODSON Elevator and Spatula

Double-ended.

NL2840

Overall length
7in (17.8cm).

NL2845

With groove.
Overall length
7in (17.8cm).



NL2830

Overall length
10in (25.4cm).

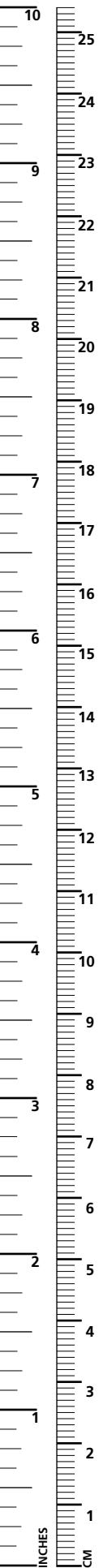

Excavator and Packer

Double-ended.

OS1085

Overall length
5-3/4in (14.6cm).



KEY Periosteal Elevators

OS1079-001

1/8in (3.1mm) wide.
Overall length 6-3/4in (17.1cm).

◆ **OS1079-002**

1/4in (6.3mm) wide.
Overall length 6-7/8in (17.5cm).

OS1079-003

3/8in (9.5mm) wide.
Overall length 7-1/4in (18.4cm).

◆ **OS1079-004**

1/2in (12.7mm) wide.
Overall length 7-1/4in (18.4cm).

OS1079-005

5/8in (15.8mm) wide.
Overall length 7-3/4in (19.7cm).

OS1079-006

3/4in (19mm) wide.
Overall length 8in (20.3cm).

OS1079-007

1in (25.4mm) wide.
Overall length 8-1/4in (21cm).



ADSON Periosteal Elevator

Sharp, square edge.



NL1100

Overall length
6-1/2in (16.5cm).



ADSON Periosteal Elevator

Curved, blunt end.



NL1101

Overall length
6-1/2in (16.5cm).



ADSON Periosteal Elevator

Straight, with rounded semi-sharp edge.



NL1103

Overall length
6-1/2in (16.5cm).



ADSON Periosteal Elevator

Curved end, semi-sharp.



NL1102

Overall length
6-1/2in (16.5cm).



Elevators

Élévateurs
Heber
Elevatori
Elevadores
Elevadores
エレベーター

LOVE-ADSON Periosteal Elevator

Semi-sharp blade,
5mm wide.



NL1120

Overall length
6-1/2in (16.5cm).



CAMPBELL Periosteal Elevator

Slightly curved blade,
16mm wide.
Mirror and Satin finish.

NL1150

Overall length
7-1/2in (19cm).



LANGENBECK Periosteal Elevator

Slightly curved.
17mm wide.

OS4000

Overall length
7-1/2in (19cm).



LANGENBECK Periosteal Elevator

Narrow. 6mm wide.

OS4001

Overall length
8-1/4in (21cm).



HOEN Periosteal Elevators

NL1085

7mm wide.
Overall length
6-1/4in (15.9cm).

NL1086

15mm wide.
Overall length
7-1/4in (18.4cm).

NL1087

20mm wide.
Overall length
7-1/2in (19.1cm).



FARABEUF Periosteal Elevator

Double-ended:
1 straight, 1 curved.

OS4050

Overall length
7-1/2in (19.1cm).



SAYRE Double-Ended Elevators

Overall length
6-1/2in (16.5cm).

OS4010

Sharp.

OS4011

Blunt.



CLOWARD-Style Periosteal Elevators

Overall length
7-3/4in (19.7cm).

NL1081

Angled 90°.

NL1080-5

No. 1. Blade
5mm wide.

NL1080-6

No. 2. Blade
6mm wide.

NL1080-8

No. 3. Blade
8mm wide.

NL1080-8C

No. 3C. Blade
8mm wide.

NL1080-12

No. 4. Blade
12mm wide.



Dissecteurs/Élévateurs
Dissektoren/Heber
Dissettori/Elevatori
Disseccionadores/Elevadores
Escalpelos/Elevadores
切開器/エレベーター

LEWIN Dissector

OS4060

Overall length
7-1/2in (19cm).



CHANDLER Bone Elevators

OS4150-001

Small.
Overall length
7-1/4in (18.4cm).

OS4150-002

Medium.
Overall length
8in (20.3cm).

OS4150-003

Large.
Overall length
9-1/4in (23.5cm).

OS4150-004

Extra-large.
Overall length
10in (25.4cm).



CREGO Elevators

Overall length
8in (20.3cm).

OS1084-001

Size 1.
Blade 6.5mm wide.

OS1084-002

Size 2.
Blade 7.1mm wide.

OS1084-003

Size 3.
Blade 14.6mm wide.



COBB Spinal Elevators

Hex handle. Overall length
9-1/2in (24cm).



NL7100-036

Blade 3/4in x 3/8in
(19mm x 10mm) wide.

NL7100-037

Blade 7/8in x 1/2in
(22mm x 13mm) wide.

NL7100-038

Blade 1-1/4in x 3/4in
(32mm x 19mm) wide.



COBB Elevators

Hex handle.
Overall length
9-1/2in (24cm).

NL7101-010

Blade 10mm wide.

◆ **NL7101-013**

Blade 13mm wide.

NL7101-019

Blade 19mm wide.

NL7101-025

Blade 25mm wide.

NL7101-032

Blade 32mm wide.



COBB Spinal Elevators

Hollow handle.
Overall length
9-1/2in (24.1cm).

NL7102-10H

Blade 3/8in
(10mm) wide.

NL7102-13H

Blade 1/2in
(13mm) wide.

NL7102-19H

Blade 3/4in
(19mm) wide.



COBB-Type Elevators

Semi-sharp blade.
Overall length
10-1/2in (26.7cm).

NL9707-001

13mm wide.

NL9707-002

19mm wide.



COBB (DAWSON-YUHL) Elevators

Overall length 11in (28cm).

NL7110-013

Blade 13mm wide.

◆ **NL7110-019**

Blade 19mm wide.

◆ **NL7110-025**

Blade 25mm wide.

NL7110-032

Blade 32mm wide.



Elevators

Élévateurs
Heber
Elevatori
Elevadores
Elevadores
エレベーター

DAWSON-YUHL Periosteal Elevator

Curved. Tip 6mm wide.

NL7100-016

Overall length
11in (27.9cm).



COBB Periosteal Elevator

Curved. Tip 13mm wide.

NL7100-017

Overall length
11in (28cm).



COBB Periosteal Elevators

Curved. Overall length
12in (30.5cm).

OS4343-001

7mm wide.

OS4343-002

10mm wide.

OS4343-003

17mm wide.



COBB-Type Elevators

Overall length
14in (35.5cm).

OS4344-001

Blade 16mm wide.

OS4344-002

Blade 19mm wide.

OS4344-003

Blade 25mm wide.



Jumbo Grip Elevators

Extra large.
Overall length
13-1/4in (33.7cm).

NL7112-010

Blade 10mm wide.

NL7112-015

Blade 15mm wide.

NL7112-020

Blade 20mm wide.

NL7112-025

Blade 25mm wide.

NL7112-030

Blade 30mm wide.

NL7112-035

Blade 35mm wide.



Jumbo Grip Elevators

Extra large.
Working length
6in (15.2cm).
Overall length
15in (38cm).

NL7114-009

Blade 9mm wide.

NL7114-013

Blade 13mm wide.

NL7114-019

Blade 19mm wide.

NL7114-025

Blade 25mm wide.

NL7114-032

Blade 32mm wide.



Periosteal Elevators

Phenolic handle.

OS1090-001Slight curve. Straight edge.
Blade 3mm. Overall length
7-1/4in (18.4cm).**OS1090-004**Slight curve. Round edge.
Blade 6mm. Overall length
7-1/4in (18.4cm).**OS1090-002**Slight curve. Straight edge.
Blade 6mm. Overall length
7-1/4in (18.4cm).**OS1090-006**Strong curve. Round edge.
Blade 14mm. Overall length
7-3/4in (19.7cm).**OS1090-008**Strong curve. Straight edge.
Blade 13mm. Overall length
7-1/2in (19cm).**Periosteal Elevators**

Straight. Phenolic handle.

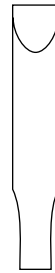
**OS1090-003**Straight edge.
Blade 6mm.
Overall length
7-1/4in (18.4cm).**OS1090-005**Round edge.
Blade 14mm.
Overall length
7-3/4in (19.7cm).**OS1090-007**Straight edge.
Blade 13mm.
Overall length
7-1/4in (18.4cm).**OS1090-009**Round edge.
Blade 20mm.
Overall length
7-3/4in (19.7cm).**SPRATT Mastoid Curettes**

Oval cup. Overall length 6-1/2in (16.5cm).

**AU6600**

Size 000. Cup 3.2mm wide.

◆ **AU6601**

Size 00. Cup 3.4mm wide.

◆ **AU6602**

Size 0. Cup 3.7mm wide.

◆ **AU6603**

Size 1. Cup 4.7mm wide.

◆ **AU6604**

Size 2. Cup 5.7mm wide.

**AU6605**

Size 3. Cup 7mm wide.

**AU6606**

Size 4. Cup 8.4mm wide.

**AU6607**

Size 5. Cup 8.9mm wide.

**AU6608**

Size 6. Cup 10.2mm wide.

**HIBBS Curettes****NL6752**Small cup.
Overall length
8in (20.3cm).**NL6757**Small cup.
Overall length
10in (25.4cm).**NL6751**Medium cup.
Overall length
8in (20.3cm).**NL6750**Large cup.
Overall length
8in (20.3cm).

Curettes

Curettes
Küretten
Curette
Curetas
キュレット

EPSTEIN Curettes

Overall length 8in (20.3cm).



OS998-001

Size 000. Cup 2.6mm wide.



OS998-002

Size 00. Cup 2.9mm wide.



OS998-003

Size 0. Cup 3.4mm wide.



PAPARELLA Curette

Straight shaft. Overall length 9-7/8in (25.2cm).



AU13820

Size 00.

Oval cup 6mm x 4mm wide. Angled 45°.



Size 0000
3mm

Size 000
3.2mm

Size 00
3.4mm

Size 0
3.7mm

Size 1
4.7mm

Size 2
5.7mm

Size 3
7mm

Size 4
8.4mm

Size 5
8.9mm

Size 6
10.2mm

BRUNS Curettes

Overall length 9in (22.9cm).

Straight	Angled Forward	Reverse Angled	Size	Cup Size
	NL6760		0000	3mm
OS993-001	NL6760-001	OS994-001	000	3.2mm
OS993-002	NL6760-002	OS994-002	00	3.4mm
OS993-003	NL6760-003	OS994-003	0	3.7mm
OS993-004	NL6760-004	OS994-004	1	4.7mm
OS993-005	NL6760-005	OS994-005	2	5.7mm
OS993-006	NL6760-006	OS994-006	3	7mm
OS993-007	NL6760-007	OS994-007	4	8.4mm
OS993-008	NL6760-008	OS994-008	5	8.9mm
OS993-009	NL6760-009	OS994-009	6	10.2mm



BRUNS Curettes

Reverse angled 90°. Overall length 8in (20.3cm).

OS909-100

Size 0.

OS909-002

Size 2.



BRUNS Curettes

Overall length 8in (20.3cm).

Straight	Angled	Reverse Angled	Size
OS992-500	NL6759-500	OS908-500	00000
OS992-400	NL6759-400	OS908-400	0000
OS992-300	NL6759-300	OS908-300	000
OS992-200	NL6759-200	OS908-200	00
OS992-100	NL6759-100	OS908-100	0
OS992-001	NL6759-001	OS908-001	1
OS992-002	NL6759-002	OS908-002	2
OS992-003	NL6759-003	OS908-003	3
OS992-004	NL6759-004	OS908-004	4
OS992-005	NL6759-005	OS908-005	5
OS992-006	NL6759-006	OS908-006	6



BRUNS Curettes

Overall length 12in (30.5cm).

Straight	Angled	Reverse Angled	Size
OS903-500	NL6764-500	OS918-500	00000
OS903-400	NL6764-400	OS918-400	0000
OS903-300	NL6764-300	OS918-300	000
OS903-200	NL6764-200	OS918-200	00
OS903-100	NL6764-100	OS918-100	0
OS903-001	NL6764-001	OS918-001	1
OS903-002	NL6764-002	OS918-002	2
OS903-003	NL6764-003	OS918-003	3
OS903-004	NL6764-004	OS918-004	4
OS903-005	NL6764-005	OS918-005	5
OS903-006	NL6764-006		6



BRUNS Curettes

Angled, knurled handle. Overall length 11in (27.9cm).

Part No.	Size
OS907-300	000
OS907-200	00
OS907-100	0
OS907-001	1
OS907-002	2
OS907-003	3
OS907-004	4
OS907-005	5
OS907-006	6



Curettes

Curettes
Küretten
Curette
Curetas
Curetas
キュレット

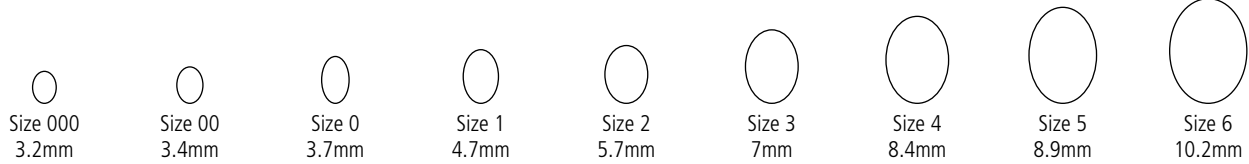

BRUNS Curettes

Straight. Hexagonal handle.
Overall length 9in (22.9cm).

Part No.	Size	Cup Size
OS997-001	000	3.2mm
OS997-002	00	3.4mm
OS997-003	0	3.7mm
OS997-004	1	4.7mm
OS997-005	2	5.7mm
OS997-006	3	7mm
OS997-007	4	8.4mm
OS997-008	5	8.9mm
OS997-009	6	10.2mm



Due to changing surgical trends, some products described in this catalog may be discontinued. Your V. Mueller sales representative may be able to suggest a suitable substitute if one is available.

Bone Curettes

Straight. Mirror finish.
Overall length 9in (22.9cm).

OS995-1

Bone curettes. Set of 9 sizes.
With rack (OS994).

Part No.	Size	Cup Size
OS995-001	000	3.2mm
OS995-002	00	3.4mm
OS995-003	0	3.7mm
OS995-004	1	4.7mm
OS995-005	2	5.7mm
OS995-006	3	7mm
OS995-007	4	8.4mm
OS995-008	5	8.9mm
OS995-009	6	10.2mm



Bone Curettes

Straight. Mirror finish.
Overall length 11-1/2in (29.2cm).

Part No.	Size	Cup Size
OS996-001	000	3.4mm
OS996-002	00	3.4mm
OS996-003	0	3.7mm
OS996-004	1	4.7mm
OS996-005	2	5.7mm
OS996-006	3	7mm
OS996-007	4	8.4mm
OS996-008	5	8.9mm
OS996-009	6	10.2mm



Curette Sterilization and Storage Rack

Y-0101

For 9in and 10in (25.4cm) curettes.



MOE Bone Curettes

Straight.
Overall length 10in (25.4cm).

Part No.	Size	Cup Size
OS988-002	00	3.4mm
OS988-003	0	3.7mm
OS988-004	1	4.7mm
OS988-005	2	5.7mm
OS988-006	3	7mm
OS988-007	4	8.4mm
OS988-008	5	8.9mm



COBB (DAWSON-YUHL) Curettes

Overall length 11in (28cm).

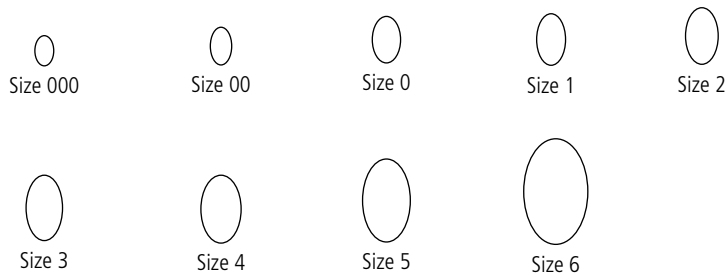

Straight	Angled Forward	Size	Cup Size
NL7105-001	NL7106-001	000	2.3mm
NL7105-002	NL7106-002	00	2.9mm
NL7105-003	NL7106-003	0	3.5mm
NL7105-004	NL7106-004	1	4mm
NL7105-005	NL7106-005	2	4.4mm
NL7105-006	NL7106-006	3	4.8mm
NL7105-007	NL7106-007	4	5mm
NL7105-008	NL7106-008	5	6.25mm
NL7105-009	NL7106-009	6	8mm

COBB Curettes

Overall length 10in (25.4cm).

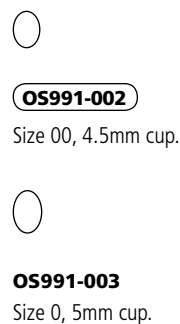

NEURO/SPINE
AND ORTHOPEDIC

Curettes

Curettes
Küretten
Curette
Curetas
Curetas
キュレット

DAWSON-YUHL Curette

Bent backwards. Cup 4mm x 8mm.



NL7100-010

Overall length
11in (27.9cm).



Jumbo Grip Cup Curettes

Extra large. Working length 4-3/4in (12.1cm).
Overall length 13-1/4in (33.7cm).

Straight	Angled	Reverse Angled	Size	Cup Size
OS990-300	NL6761-300	OS999-300	3-0	
OS990-200	NL6761-200	OS999-200	2-0	
OS990-100	NL6761-100	OS999-100	1-0	
OS990-001	NL6761-001	OS999-001	1	
OS990-002	NL6761-002	OS999-002	2	7mm
OS990-003	NL6761-003	OS999-003	3	9mm
OS990-004	NL6761-004	OS999-004	4	11mm
OS990-005	NL6761-005	OS999-005	5	13mm
OS990-006	NL6761-006	OS999-006	6	15mm
OS990-007	NL6761-007	OS999-007	7	17mm



COLLIS® Cup Curette

Overall length 11in (28cm).



NL9318-001

Size 0.



Jumbo Grip Curettes

Extra large. Overall length 15in (38cm).

Straight	Angled	Reverse Angled	Size	Cup Size
OS986-300	NL6762-300	OS987-300	3-0	
OS986-200	NL6762-200	OS987-200	2-0	
OS986-100	NL6762-100	OS987-100	1-0	
OS986-001	NL6762-001	OS987-001	1	
OS986-002	NL6762-002	OS987-002	2	7mm
OS986-003	NL6762-003	OS987-003	3	9mm
OS986-004	NL6762-004	OS987-004	4	11mm
OS986-005	NL6762-005	OS987-005	5	13mm
OS986-006	NL6762-006	OS987-006	6	15mm
OS986-007	NL6762-007	OS987-007	7	17mm



LAMBOTTE Mini Osteotomes

Straight. Overall length 5in (12.7cm).

Straight	Curved	Blade Width
OS1062-002	OS1063-002	2mm
OS1062-004	OS1063-004	4mm
OS1062-006	OS1063-006	6mm
OS1062-008	OS1063-008	8mm
OS1062-010	OS1063-010	10mm
OS1062-012	OS1063-012	12mm
OS1062-014	OS1063-014	14mm
OS1062-015	OS1063-015	15mm
OS1062-018		18mm
OS1062-019		19mm
OS1062-020		20mm



LAMBOTTE Osteotomes

Straight.
Overall length
6-3/4in (17.1cm).

OS1057-004
Blade 4mm wide.

OS1057-006
Blade 6mm wide.

OS1057-008
Blade 8mm wide.

OS1057-010
Blade 10mm wide.

OS1057-012
Blade 12mm wide.



LAMBOTTE Osteotome

Curved.
Overall length
6-3/4in (17cm).

OS1058-010
Blade 3/8in
(10mm) wide.



Small Osteotomes

Overall length 7-1/4in (18.5cm).

OS1059
Set includes 8 osteotomes
and 1 mallet.

OS1059-002
Straight. Blade 22mm wide.

OS1059-003
Straight. Blade 16mm wide.

OS1059-004
Straight. Blade 12mm wide.

OS1059-005
Straight. Blade 10mm wide.

OS1059-006
Straight. Blade 8mm wide.

OS1059-007
Curved. Blade 7mm wide.

OS1059-008
Straight. Blade 6mm wide.

OS1059-009
Straight. Blade 4mm wide.

OS1059-010
Mallet. Head diameter
1in (2.5cm). Weight 8oz.



LAMBOTTE Osteotomes

Straight. Overall length 9in (23cm).

◆ **OS1060**
Set of 6.

◆ **OS1060-006**
Blade 1/4in (6mm) wide.

OS1060-013
Blade 1/2in (13mm) wide.

OS1060-019
Blade 3/4in (19mm) wide.

OS1060-025
Blade 1in (25mm) wide.

OS1060-032
Blade 1-1/4in (32mm) wide.

OS1060-038
Blade 1-1/2in (38mm) wide.



LAMBOTTE Osteotomes

Curved. Overall length 9in (23cm).

◆ **OS1061**
Set of 6.

OS1061-006
Blade 1/4in (6mm) wide.

OS1061-013
Blade 1/2in (13mm) wide.

OS1061-019
Blade 3/4in (19mm) wide.

OS1061-025
Blade 1in (25mm) wide.

OS1061-032
Blade 1-1/4in (32mm) wide.

OS1061-038
Blade 1-1/2in (38mm) wide.



Osteotomes

Ostéotomes
Osteotome
Osteotomi
Osteótomos
Osteótomos
骨刀

Osteotome Sterilization and Storage Rack

For 9in (23cm) LAMBOTTE osteotomes.
Holds 12.

◆ **OS1065**



HOKE Osteotomes

Overall length 6in (15.2cm).

Straight	Curved	Blade Width
OS4280-005	OS4281-005	1/8in (3mm)
OS4280-006	OS4281-006	3/16in (5mm)
OS4280-001	OS4281-001	1/4in (6mm)
OS4280-009	OS4281-009	5/16in (9mm)
OS4280-002	OS4281-002	3/8in (10mm)
OS4280-003	OS4281-003	1/2in (13mm)
OS4280-004	OS4281-004	5/8in (16mm)



U.S. ARMY-Type Osteotomes

Overall length
6-1/2in (16.5cm).

OS4270-001

Blade 6mm wide.

OS4270-002

Blade 12mm wide.

OS4270-003

Blade 18mm wide.



CHERRY Osteotome

Curved. Blade 4mm wide.

NL6575-004

Overall length
7-3/4in (19.7cm).



CHERRY Osteotomes

Straight. 1-piece construction
on octagonal handle.

Overall length
8in (20.3cm).

NL6570-003

Blade 3mm wide.

NL6570-004

Blade 4mm wide.

NL6570-005

Blade 5mm wide.

NL6570-006

Blade 6mm wide.

NL6570-007

Blade 7mm wide.



STILLE-Type Osteotomes

Overall length
8in (20.3cm).

OS4230-001

Blade 10mm wide.

OS4230-002

Blade 12mm wide.

OS4230-003

Blade 15mm wide.

OS4230-004

Blade 20mm wide.



SMITH-PETERSON Osteotomes

Overall length 8-1/4in (21cm).

Straight	Curved	Blade Width
OS4173	OS4182	1/4in (6mm)
OS4174	OS4183	3/8in (9.5mm)
OS4175	OS4184	1/2in (13mm)
OS4176	OS4185	5/8in (16mm)
OS4177	OS4186	3/4in (19mm)
OS4178	OS4188	1in (25mm)
	OS4189	1-1/2in (38mm)



SMITH-PETERSEN Storage Rack

Holds 7. Storage Racks.

OS4940

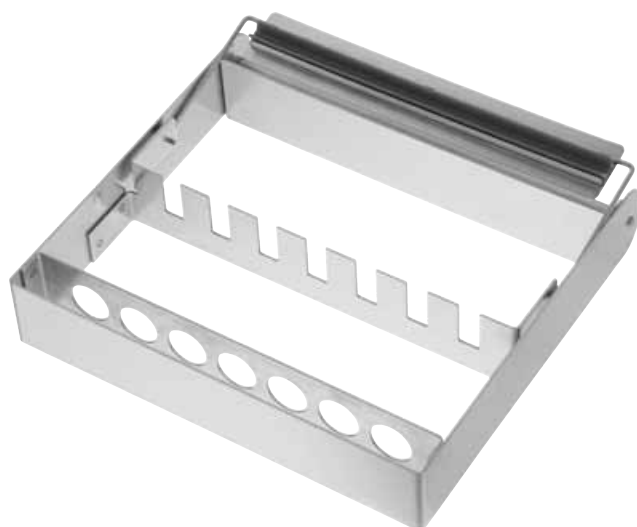

Instrument sizes, particularly overall lengths, are specified in this catalog as accurately as possible. Slight variations may occur due to metal crafting and finishing operations. Refer to the introductory pages for clarification on measurements. We reserve the right to modify products and/or services depicted herein without customer notice.

Osteotomes/Chisels

Ostéotomes/Ciseaux
 Osteotome/Meißel
 Osteotomi/Scalpelli
 Osteótomos/Cinceles
 Osteótomos/Cinzéis
 骨刀/のみ

HIBBS Osteotomes

Overall length 9-1/2in (24.1cm).

Straight	Curved	Blade Width
OS4295-001	OS4295-011	1/4in (6mm)
OS4295-002	OS4295-012	3/8in (9.5mm)
OS4295-003	OS4295-013	1/2in (13mm)
OS4295-004	OS4295-014	5/8in (16mm)
OS4295-005	OS4295-015	3/4in (19mm)
OS4295-006	OS4295-016	7/8in (22mm)
OS4295-007	OS4295-017	1in (25mm)
OS4295-008	OS4295-018	1-1/8in (28mm)
OS4295-009	OS4295-019	1-1/4in (32mm)
OS4295-010	OS4295-020	1-1/2in (38mm)



COBB Osteotomes

Overall length 11in (27.9cm).

Straight	Curved	Blade Width
OS4330-006	OS4331-006	1/4in (6mm)
OS4330-010	OS4331-010	3/8in (9.5mm)
OS4330-013	OS4331-013	1/2in (13mm)
OS4330-016	OS4331-016	5/8in (16mm)
OS4330-019	OS4331-019	3/4in (19mm)
OS4330-025	OS4331-025	1in (25mm)
OS4330-032	OS4331-032	1-1/4in (32mm)



DAWSON-YUHL Osteotomes

Overall length
 11in (27.9cm).

NL7100-014
 Tip 6.5mm wide.

NL7100-015
 Tip 12mm wide.



HIBBS Chisel Elevator

Overall length
 7-1/4in (18.5cm).

NL6660
 5/8in (18mm) wide.



STILLE-Type Bone Chisels

Overall length
 8in (20.3cm).

OS4220-001
 10mm wide.

OS4220-002
 12mm wide.



Ciseaux/Jauges
 Meißel/Hohlmeißel
 Scalpelli/Scalpelli cavi
 Cinceles/Gubias
 Cinzéis/Verrumas
 のみ/たがね

HIBBS Bone Chisels

Overall length 9-1/2in (24.1cm).

Straight	Curved	Blade Width
OS4290-001	OS4290-011	1/4in (6mm)
OS4290-002	OS4290-012	3/8in (9.5mm)
OS4290-003	OS4290-013	1/2in (13mm)
OS4290-004	OS4290-014	5/8in (16mm)
OS4290-005	OS4290-015	3/4in (19mm)
OS4290-006	OS4290-016	7/8in (22mm)
OS4290-007	OS4290-017	1in (25mm)
OS4290-008	OS4290-018	1-1/8in (28mm)
OS4290-009	OS4290-019	1-1/4in (32mm)
OS4290-010	OS4290-020	1-1/2in (38mm)



STILLE-Type Bone Gouges

Overall length 8in (20.3cm).

OS4310-002

12mm wide.

OS4310-003

15mm wide.



Swan Neck Gouge

Hex handle.

OS4346

Overall length 9in (22.9cm).



SMITH-PETERSON Gouges

Overall length 8in (20.3cm).

Straight	Curved	Blade Width
J-0400	J-0407	1/4in (6mm)
J-0401	J-0408	3/8in (10mm)
J-0402	J-0409	1/2in (13mm)
J-0403	J-0410	5/8in (16mm)
J-0404	J-0411	3/4in (19mm)
J-0405	J-0412	1in (25mm)
J-0406	J-0413	1-1/4in (32mm)



HIBBS Gouges

Overall length 9-1/2in (24.1cm).

Straight	Curved	Blade Width
OS4360-001	OS4360-011	1/4in (6mm)
OS4360-002	OS4360-012	3/8in (10mm)
OS4360-003	OS4360-013	1/2in (12mm)
OS4360-004	OS4360-014	5/8in (16mm)
OS4360-005	OS4360-015	3/4in (19mm)
OS4360-006	OS4360-016	7/8in (22mm)
OS4360-007	OS4360-017	1in (25mm)
OS4360-008	OS4360-018	1-1/8in (29mm)
OS4360-009	OS4360-019	1-1/4in (32mm)
OS4360-010	OS4360-020	1-1/2in (38mm)



Gouges/Mallets

Jauges /Maillets
Hohlmeißel/Schlägel
Scalpelli cavi/Magli
Gubias/Mazos
Verrumas/Malhetes
たがね/木槌

MOE Gouges

Straight.
Overall length
10in (25.4cm).

OS4340-003

Wide.

OS4340-004

Narrow.



COBB Gouge

Modified style, straight.

OS4340-001

Overall length
10-5/8in (27cm).



COBB Gouge

Bayonet shaped.

OS4340-002

Overall length
10-5/8in (27cm).



DAWSON-YUHL Gouge

NL7100-011

Straight.
Tip 7mm wide.
Overall length
11in (27.9cm).



DAWSON-YUHL Gouge

NL7100-012

Bayonet.
Tip 7mm wide.
Overall length
11in (27.9cm).



Mallet

Used generally with Osteotomes OS1059-series.
Head diameter 1in (2.5cm). 1 side stainless steel,
the other side nylon. Weight 8 oz (227g).

◆ **OS1059-010**

Overall length
7-1/4in (18.5cm).



CRANE Mallet

Short handle. Face 1-3/16in (3cm) diameter.
Weight 8 oz (227g).

NL7020

Overall length
6-1/4in (15.9cm).



Maillets
Schlägel
Magli
Mazos
Malhetes
木槌

GERZOG Mallet

Lead filled head.
Head diameter
1in (2.5cm). Weight
14 oz (397.3g).

OS1512

Overall length
7-1/4 (18.6cm).

**HEATH Mallet**

Heavyweight. Head diameter 40mm.
Weight 1 lb, 13 oz (822.7g).

◆ **OS1523**

Overall length
7-1/4in (18.4cm).

**Orthopaedic Mallets**◆ **OS1518**

Head 1-3/16in (3cm)
diameter. Weight
1 lb (454g).
Overall length
7-3/16in (18.3cm).

◆ **OS1519**

Head 1-1/2in (3.8cm)
diameter. Weight
2 lb (908g).
Overall length
7-9/16in (19.3cm).

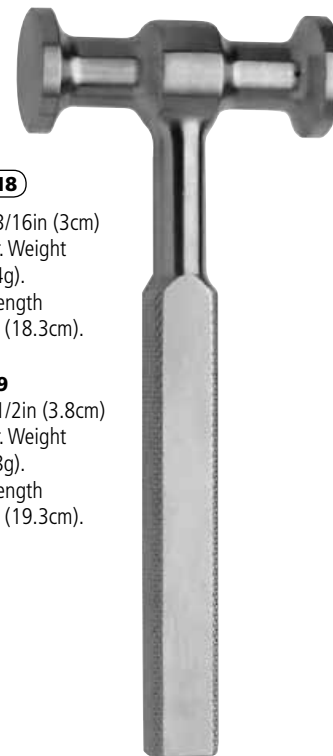
**KIRK Mallet**

Stainless steel head.
Head diameter
1-1/2in (3.8cm).
Head weight
26 oz (737.8g).

OS1513

Overall length
7-3/4in (19.7cm).

**LUCAE Bone Mallet**

Face 1-1/8in (2.8cm) diameter.
Weight 11oz (311.3g).
Mirror and Satin finish.

NL7000

Overall length
8in (20.3cm).

**MEAD Mallets**

Head diameter 1in (26mm).
Weight 11oz (312g).
Mirror Finish.

OS1520

Overall length
7-1/2in (19.1cm).

OS1521

Nylon replacement
caps only.



Mallets/Bone Tamps

Maillets/Ballonnets gonflables de cimentation osseuse
 Schlägel/Knochenstößel
 Magli/Dispositivi di compressione ossea
 Mazos/Impactores óseos
 Malhetes/Calcadores ósseos
 木槌/ボーンランプ

BERGMAN Mallet

Weight 11 oz (312g).
 Aluminum alloy handle.

OS1517

Overall length
 9-1/2in (24.1cm).



PHENOLIC Handle Mallets

Overall length
 11in (27.9cm).

OS1525

Head diameter 33mm.
 Weight 1 lb 11 oz (766.1g).

OS1526

Head diameter 45mm.
 Weight 2 lb 9 oz (1163.4g).



Toronto Bone Mallets

Surface diameter 2-1/4in x 1-7/8in
 (5.7cm x 4.8cm).
 Overall length 8in (20.3cm).

OS1528

24oz.

OS1527

30oz.



CLOWARD-Style Mallets

NL7049

19mm face.
 Overall length
 7-1/2in (19cm).

NL7040

25mm face.
 Overall length
 9in (22.9cm).



CLOWARD-Style Depth Gauge

NL5245

Large.

NL5246

Small.



CLOWARD-Style Bone Impactor

Double-ended.

NL9112

Overall length
 8-3/4in (22.2cm).



Bone Tamps

Cross-serrated tip.
 Overall length
 6-1/4in (15.9cm).

OS1610-002

Tip diameter 2mm.

OS1610-003

Tip diameter 3mm.

OS1610-004

Tip diameter 4mm.

OS1610-005

Tip diameter 5mm.



OS1610-006

Tip diameter 6mm.

OS1610-008

Tip diameter 8mm.

OS1610-010

Tip diameter 10mm.



Impacteurs/Rugines
 Impaktoren/Raspeln
 Dispositivi d'urto/Raschietti
 Impactadores/Raspadores
 Impactadores/Raladores
 インパクト/石目やすり

Bone Impactors

With replaceable nylon caps.
 Head diameter 20mm.
 Aluminum.

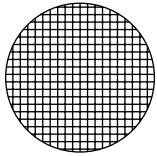

OS1612

Overall length
 6-1/2in (16.5cm).

OS1612-001

Nylon replacement caps
 for Bone Impactor OS1612.



MOE Impactors

Overall length
 10in (25.4cm).

OS4341-001

Small.

OS4341-002

Large.



DAWSON-YUHL Impactor

Tip 12.5mm wide.

NL7100-019

Overall length
 11in (27.9cm).



MILLER Rasp

Double-ended.

OS4464-002

Overall length
 7-1/4in (18.4cm).



FOMAN Rasp

Double-ended.
 Double-sided.
 Fine and
 coarse teeth.
 Convex and
 flat blades,
 8mm wide.

◆ **RH2010-003**

Overall length
 8-1/2in (21.6cm).

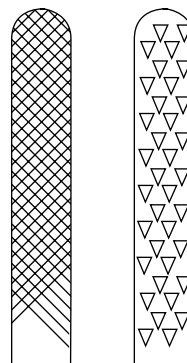
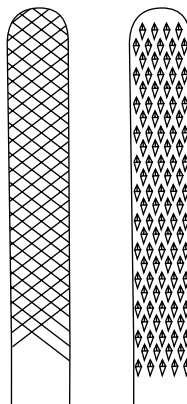

PUTTI Bone Rasp

Double-ended,
 with flat,
 tapering blades;
 1 blade curved on flat.

◆ **OS4450**

Overall length
 10-1/2in (26.7cm).



Rugines/Limes/Scies/Couteaux
 Raspeln/Feilen/Sägen/Messer
 Raschietti/Lime/Seghe/Bisturi
 Raspadores/Limas/Sierras/Cuchillos
 Raladores/Limas/Serras/Facas
 石目やすり/やすり/のこぎり/ナイフ

PUTTI Bone Rasp

Double-ended,
 with 2 tapering blades;
 1 flat, 1 conical.

OS4455

Overall length
 11-3/4in (29.8cm).



Bone File

Bayonet shank.
 Blade 3-1/2in x 1/2in
 (8.9cm x 1.3cm) wide.

OS4462

Overall length
 9in (22.9cm).



CHARRIERE Amputating Saw

Chrome
 plated blade,
 8in (20.3cm).

OS5930

Overall length
 11-1/2in (29.2cm).



SATTERLEE Bone Saw

OS5931



LISTON Amputation Knives

OS5932-17
 Blade length
 6-3/4in (17.2cm).

OS5932-20

Blade length
 8in (20.3cm).



SWEET Amputation Shield

OS5800

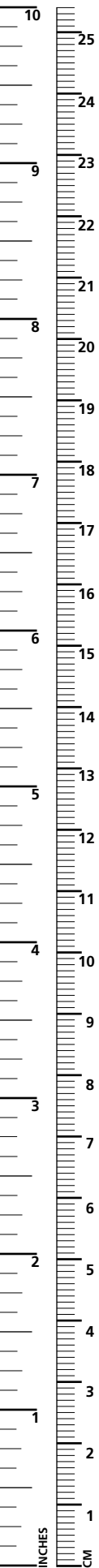
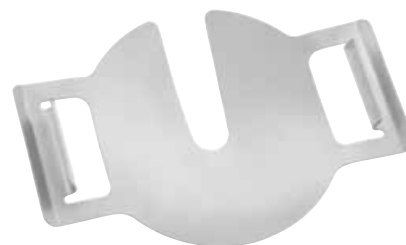

Pinces coupe-os
Knochensplitterzange
Pinze di taglio ossa
Fórceps de corte del hueso
Pinça para corte ósseo
骨切斷鉗子

LISTON Bone Cutting Forceps

Straight jaws.

OS4640

Overall length
5-1/2in (14cm).



LISTON Bone Cutting Forceps

Curved jaws.

OS4650

Overall length
5-1/2in (14cm).



LITTAUER-LISTON Bone Cutting Forceps

Light, for small bones.

◆ **OS4610**

Overall length
5-3/4in (14.6cm).



HORSLEY Bone Cutting Forceps

Straight.

OS4620

Overall length
7-3/4in (19.7cm).



KLEINERT-KUTZ Bone Cutting Forceps

Double-action.
Overall length
5-1/2in (14cm).

◆ **OS4723-001**

Straight blades.

OS4723-002

Curved blades.



Bone Cutting Forceps

Pointed jaw, length
3/4in (2cm).

◆ **OS4730**

Overall length
5-3/4in (14.6cm).



Bone Cutting Forceps/Rongeurs

Pincas coupe-os/Pincas-gouges
Knochensplitterzange/Rongeure
Pinze di taglio ossa/Pinze ossivore
Fórceps de corte del hueso/Gubias
Pinça para corte ósseo/Saca-bocados
骨切斷鉗子/骨鉗子

Bone Cutting Forceps

Double-action.
Overall length
7-1/4in (18.4cm).

◆ **OS4735**

Straight.

OS4735-001

Angled up.



RUSKIN Bone Splitting Forceps

Double-action.
Overall length
7-3/8in (18.7cm).

◆ **CH470**

Straight blades.

CH471

Angled blades.



HORSLEY Bone Cutting Forceps

Double-action with double bend.

◆ **OS4720**

Overall length
10in (25.4cm).



LISTON-STILLE-Type Bone Cutting Forceps

Double-action bone
cutting forceps.
Overall length
10-1/2in (26.7cm).

◆ **OS4700**

Straight.

◆ **OS4710**

Curved.

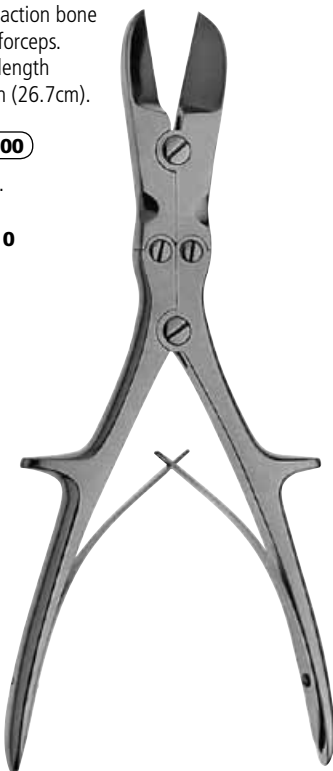

Micro Tissue Rongeurs

Extra delicate. 2mm x 5mm bite.
Overall length 7in (17.8cm).

AU6786-001

Curved.

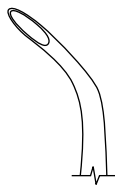

AU6786-002

Strong curve.



Custom etching

Custom etching is available on stainless steel surgical instruments on new orders as they are purchased. Ask your customer support representative at **800.323.9088** for more information.

Pince-gouge
 Rongeur-Zangen
 Pinza ossivora
 Fórceps de gubias
 Pinça saca-bocado
 骨鉗子

FRIEDMANN Taper Jaw Rongeur Forceps

Half-curved. Cup 12mm x 3mm wide.



OS1116

Overall length
 5in (12.7cm).



FRIEDMAN Micro Rongeurs

1.3mm x 5mm bite.
 Overall length
 5-1/2in (14cm).

AU11355-01

Straight.



◆ **AU11355-02**

Curved.

AU11355-03

Angled 90°.



ANDREWS-HARTMANN Rongeur Forceps

Slightly curved.



AU6700

Overall length
 5-5/8in (14.4cm).



SHEARER Chicken-Bill Rongeur Forceps

Small jaws.

MO640

Overall length
 5-3/4in (14.5cm).



Rongeur Forceps

Pince-gouge
Rongeur-Zangen
Pinza ossivora
Fórceps de gubias
Pinça saca-bocado
骨鉗子

Bone Joint Rongeurs

Ring handled.

AU6785

Strong curve. Jaws 1mm wide.
Overall length 5in (12.7cm).

AU6795-012

Slight curve. Jaws 1.2mm wide.
Overall length 5-3/4in (14.6cm).

AU6795-020

Slight curve. Jaws 2mm wide.
Overall length 5-3/4in (14.6cm).

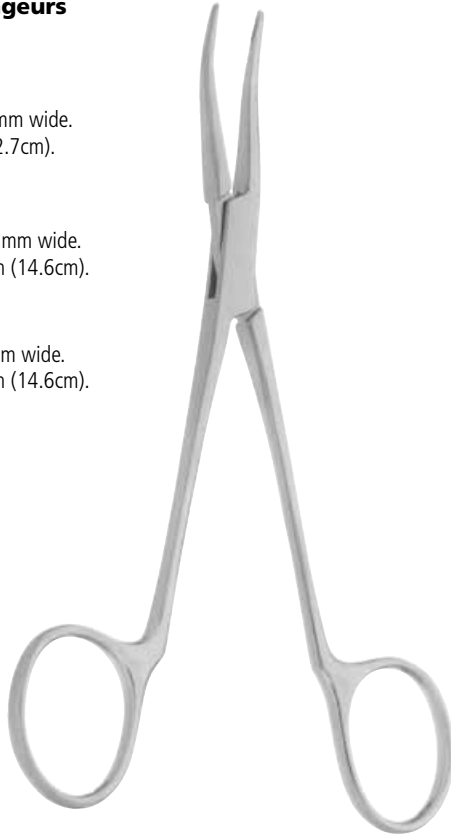

LEMPERT Rongeur Forceps

Light model with slender jaws.



AU11370

Jaws 7mm x 2.5mm wide.
Overall length
7-1/2in (19cm).



AU11372

Jaws 10mm x 2mm wide.
Overall length
6-1/2in (16.5cm).



AU11374

Jaws 10mm x 3mm wide.
Overall length
9in (22.9cm).



LUER Rongeur Forceps

Cup-shaped jaws, 13mm x 8mm wide.
Overall length 7in (17.8cm).

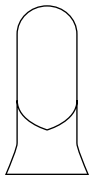

NL530

Straight.

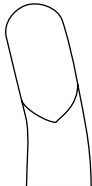

NL535

Curved.



CUSHING Cranial Rongeur Forceps

Curved jaws, 11mm x 8.5mm wide.



NL520

Overall length
7-1/4in (18.4cm).



Pince-gouge
 Rongeur-Zangen
 Pinza ossivora
 Fórceps de gubias
 Pinça saca-bocado
 骨鉗子

ADSON Cranial Rongeur

Straight. Cup-shaped jaws,
 15mm x 7.5mm wide.

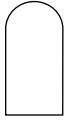

◆ **NL500**

Overall length
 8-1/4in (21cm).

NL501

Toothed jaws.
 Overall length
 8in (20.3cm).



ADSON Cranial Rongeur Forceps

Angular cup-shaped jaws,
 14mm x 7.7mm wide.

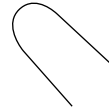

◆ **NL540**

Overall length
 8-1/4in (21cm).

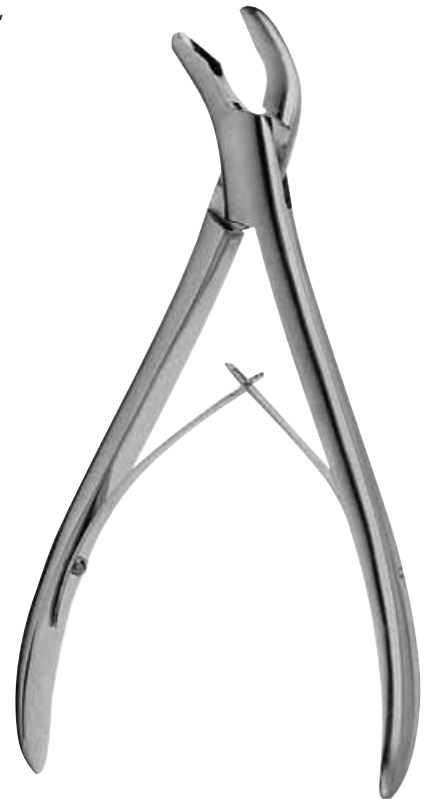

BACON Cranial Rongeur Forceps

Angular cup-shaped jaws,
 14mm x 6.8mm wide.

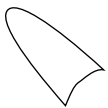

◆ **NL550**

Overall length
 8-1/4in (21cm).



McINDOE Rongeur Forceps

Double-action, slightly curved.
 Overall length 6in (15.2cm).



◆ **OS1115-001**

Jaws 3mm wide.



OS1115-002

Jaws 5mm wide.



Rongeur Forceps

Pince-gouge
Rongeur-Zangen
Pinza ossivora
Fórceps de gubias
Pinça saca-bocado
骨鉗子

KLEINERT-KUTZ Rongeur Forceps

Overall length 6in (15.2cm).



◆ **OS1115-003**

Jaws 3mm wide, small size.



OS1115-004

Jaws 4mm wide, large size.



ZAUFEL-JANSEN Bone Rongeurs

Curved. Overall length 7in (17.8cm).

OS1115-006

Jaws 5mm wide.



STOOKEY Ronguer

Overall length 7-1/2in (19cm).

NL634

Angled. 3mm bite.



SMITH-PETERSEN Rongeurs

OS4740

Straight. 3mm bite.
Overall length 7-1/2in (19cm).

OS4745

Slight curve. 3mm bite.
Overall length 7-1/2in (19cm).

OS4750

Full curve. 3mm bite.
Overall length 7-1/2in (19cm).

OS4900

Straight. 3mm bite.
Overall length 9-1/2in (24.1cm).

OS4915

Slight curve. 3mm bite.
Overall length 9-1/2in (24.1cm).

OS4920

Full curve. 3mm bite.
Overall length 9-1/2in (24.1cm).

OS4930

Straight. 7mm bite.
Overall length 9in (23cm).



Pince-gouge
 Rongeur-Zangen
 Pinza ossivora
 Fórceps de gubias
 Pinça saca-bocado
 骨鉗子

FULTON Laminectomy Rongeurs

Double-action. Bite 5mm wide.

OS4980

Straight.
 Overall length 7-1/2in (19cm).

OS4985

Curved.
 Overall length 7-1/2in (19cm).

OS4990

Straight.
 Overall length 9-1/2in (24cm).

OS4995

Curved.
 Overall length 9-1/2in (24cm).



KLEINERT-KUTZ Rongeur

Curved. 2mm x 13mm bite.



OS1115-005

Overall length
 6in (15.2cm).



RUSKIN Mini Rongeurs

Bite 15mm x 3mm wide.
 Overall length
 6in (15.2cm).

AU6784-001

Straight.

AU6784-002

Curved.



RUSKIN Rongeur Forceps

Double-action. Overall length 7-1/2in (19cm).



◆ **AU6780**

Slightly curved jaws.
 5mm wide.

AU6780-001

Straight jaws.
 5mm wide.



AU6781

Slightly curved jaws.
 6mm wide.



○ Instrument pictured

◆ Most widely used patterns

Rongeur Forceps

Pince-gouge
Rongeur-Zangen
Pinza ossivora
Fórceps de gubias
Pinça saca-bocado
骨鉗子

RUSKIN Rongeur Forceps

Duckbill, curved pattern.
Cup 6mm x 16mm.

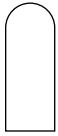

OS1013-005

Overall length
7in (17.8cm).



STILLE-LUER-Type Rongeur Forceps

Double-action. Jaws 10mm wide.
Overall length 8-1/2in (21.6cm).

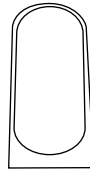

◆ **NL610**

Straight jaws.

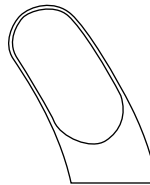

◆ **NL620**

Curved jaws.



STILLE-Type Rongeur Forceps

Double-action. Jaws angled to the side.
Overall length 9in (22.9cm).

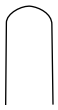

◆ **NL600**

Jaws 6mm wide.



◆ **NL615**

Jaws 3mm wide.



LEKSELL Rongeur Forceps

Double-action. Regular curve.



◆ **NL630**

Jaws 16mm x 8mm wide. Overall length
8-1/2in (21.6cm).



◆ **NL631**

Jaws 16mm x 5mm wide. Overall length
8-1/2in (21.6cm).



◆ **NL632**

Jaws 16mm x 3mm wide. Overall length
9-3/4in (24.8cm).

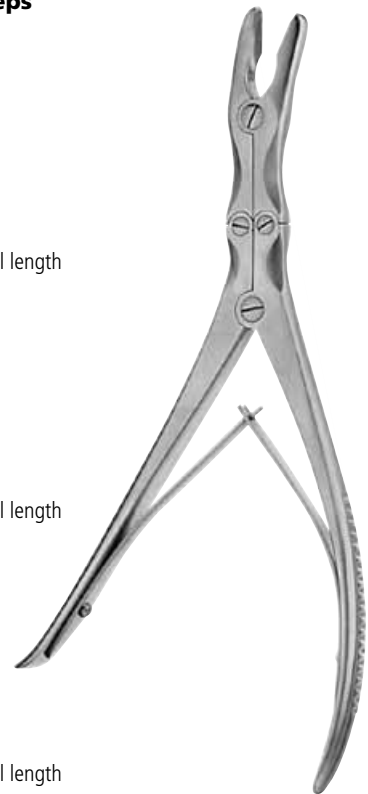

Pince-gouge
 Rongeur-Zangen
 Pinza ossivora
 Fórceps de gubias
 Pinça saca-bocado
 骨鉗子

LEKSELL Rongeur Forceps

Double-action. Fully curved.



◆ **NL630-001**

Jaws 13mm x 7mm wide. Overall length 8-1/2in (21.6cm).



NL631-001

Jaws 16mm x 5mm wide. Overall length 9-5/8in (24.5cm).



NL633

Jaws 13mm x 3mm wide. Overall length 9-1/4in (23.5cm).

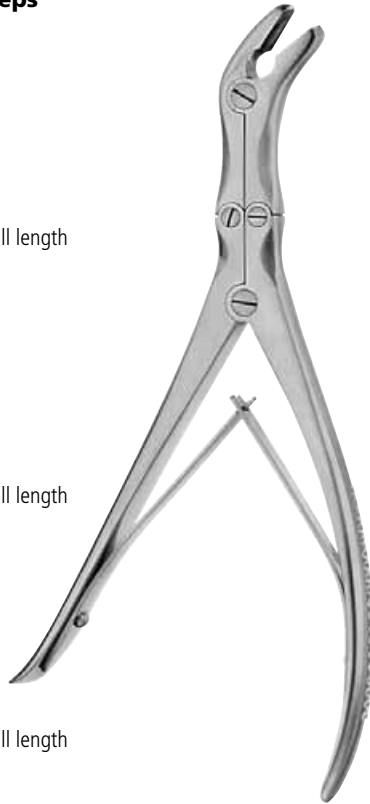

ECHLIN Rongeur Forceps

Double-action. Duckbill pattern, narrow, angular jaws. Overall length 9in (22.9cm).



OS1110

Jaws 2mm x 10mm.

OS1112

Jaws 3mm x 10mm.



DAWSON-YUHL Rongeur Forceps

LEMPERT-type. Straight. Jaws 4mm.



NL7100-042

Overall length 11in (27.9cm).



DAWSON-YUHL-LEKSELL Rongeur Forceps

Angular cup-shaped jaws. Overall length 11-1/2in (29.2cm).

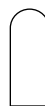

NL7100-040

Jaws 5mm x 13mm.



NL7100-041

Jaws 2mm x 13mm.

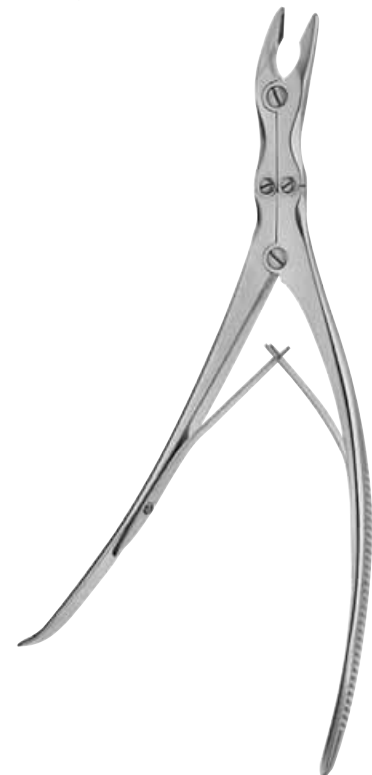

○ Instrument pictured

◆ Most widely used patterns

Forceps/Pliers

Forceps/Pinces
Zangen/Zangen
Pinze/Pinze
Fórceps/Alicates
Fórceps/Alicates
鉗子/ペンチ

Wire Pulling Forceps

Capacity 1mm.



OS3085

Overall length
6-1/2in (16.5cm).



Needle Nose Pliers

Overall length 5-1/2in (14cm).

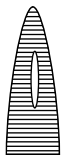

OS3071

Delicate. Tip 1mm wide.

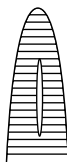

OS3072

Tip 2mm wide.



Long Jaw Needle Nose Pliers

Tip 2mm wide. Jaw length 5.7cm.



OS3075

Overall length
6in (15.2cm).



Flat Nose Pliers

Tip 4mm wide.

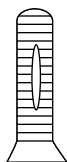

OS3073

Overall length
5-1/2in (14cm).



Flat Nose Pliers

Overall length
7in (17.8cm).

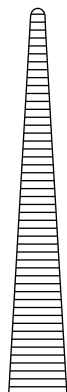

OS3074

Delicate.
Tip 2mm wide.
Jaw length 5.1cm.



Flat Nose K-Wire Pliers

Overall length 6-3/4in (17.1cm).



OS3080-002

Tip 5mm wide.

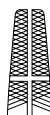

OS3080-001

Tip 6mm wide.
Side grooved.



Utility Pliers

Slip joint. Tip 10mm wide.

◆ **OS3070**

Overall length
7-3/4in (19.7cm).



Parallel Pliers

Maximum opening 13mm.
Jaw 10mm wide.

OS3077

Overall length
7-1/2in (19.1cm).



Pliers/Wire Cutters

Pincas/Coupe-fils
Zangen/Drahtschneider
Pinze/Tagliafili
Alicates/Cortaalambres
Alicates/Cortadores de fios
ペンチ/ワイヤカッター

Needle Nose Locking Pliers

Tip 5mm wide. Jaw length 5.7cm.

OS3091-001

Overall length
9-3/4in (24.8cm).



Heavy Duty Locking Pliers

Jaw 9mm wide.

◆ **OS3090-002**

Overall length
8in (20.3cm).



VITAL® Pin Pulling Pliers

Tip 3mm wide. Tungsten Carbide inserts.

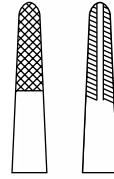

OS3082

Overall length
5-3/4in (14.6cm).



VITAL® Wire Extraction Pliers

Double-action. Overall length
7-1/2in (19.1cm). Tungsten Carbide inserts.

OS3081-001

Jaws 2mm wide.



OS3081-002

Jaws 4mm wide.

OS3081-003

Jaws 6mm wide.



Needle Nose Pliers/Wire Cutter

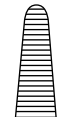

◆ **OS901**

Overall length
6-3/8in (16.2cm).



VITAL® Heavy-Duty Pliers/Wire Cutter

Overall length
8-1/2in (21.6cm).

OS3076



Coupe-fils
Drahtschneider
Tagliafili
Cortaalambres
Cortadores de fios
ワイヤカッター

VITAL® Wire Cutter

Capacity 1.6mm.

◆ **OS3065**

Overall length
8in (20.3cm).



VITAL® Wire Cutters

Double-action. Side cutting. Angled.

◆ **OS3052-001**

Capacity 1.6mm.
Overall length
6-1/2in (16.5cm).

◆ **OS3052-002**

Capacity 2.4mm.
Overall length
9in (22.9cm).



VITAL® Wire Cutter

Side cutting.
Capacity 2.4mm.

◆ **OS3051**

Overall length
9in (22.9cm).



VITAL® Wire Cutter

Double-action. Front and side cutting.
Capacity 1.6mm.

◆ **OS3040**

Overall length
6-3/4in (17.1cm).



VITAL® Flush Wire/Cable Cutter

Double action. Front and side cutting.
Capacity 1.6mm.

◆ **OS3041**

Overall length
6-3/4in (17.1cm).



VITAL® Wire Cutter

End cutting. Capacity 1.6mm.
Tungsten Carbide inserts.

◆ **OS3046**

Overall length
5-3/4in (14.6cm).



Wire Cutters

Coupe-fils
Drahtschneider
Tagliafili
Cortaalambres
Cortadores de fios
ワイヤカッター

VITAL® Wire Cutter

Capacity 2.4mm.

OS3045

End cutting.
Overall length
8-1/2in (21.6cm).



VITAL® Cable Cutter

Capacity 2mm.

OS3020

Overall length
7in (17.8cm).

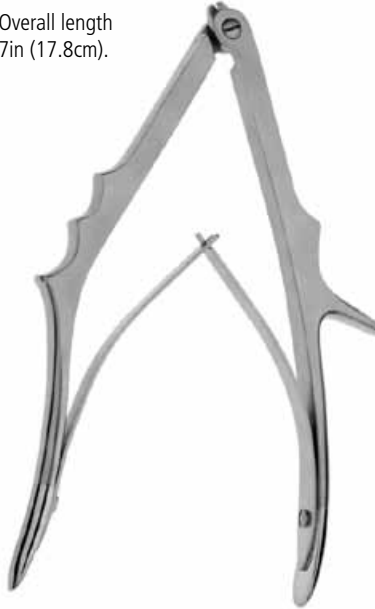

VITAL® Advanced Wire Cutters

Tungsten Carbide blades and rubber jaws.

OS3031

Overall length
7in (18cm).
Left handed.
For drill wires
up to 2.2mm.

OS3032

Overall length
7in (18cm).
Right-handed.
For drill wires
up to 2.2mm.

OS3033

Overall length
9in (23cm).
For drill wires
up to 3mm.



VITAL® Advanced Front and Side Cutters

Tungsten Carbide blades and rubber jaws. For
drill wires up to 1.6mm.

OS3034

Overall length
7in (18cm).



VITAL® Advanced Cable Cutters

Tungsten Carbide blades. For cables 1-2mm.

OS3036

Overall length
7in (18cm).



VITAL® Advanced Extraction Forceps

Tungsten Carbide jaws.

OS3037

Overall length
7in (18cm).
Jaw size 3mm.

OS3038

Jaw size 6mm.



Vital® Advanced Wire Cutters Replacement Parts

OS3031-001

One pair tungsten carbide replacement blades.
 Two pairs of screws. Allen key. For OS3031 and OS3032.

OS3031-002

One pair rubber replacement jaws. For OS3031 and OS3032.

OS3033-001

One pair tungsten carbide replacement blades.
 Two pairs of screws. Allen key. For OS3033.

OS3034-001

One pair tungsten carbide replacement blades.
 Two pairs of screws. Allen key. For OS3034.

OS3036-001

One pair tungsten carbide replacement blades.
 One pairs of screws. Allen key. For OS3036.

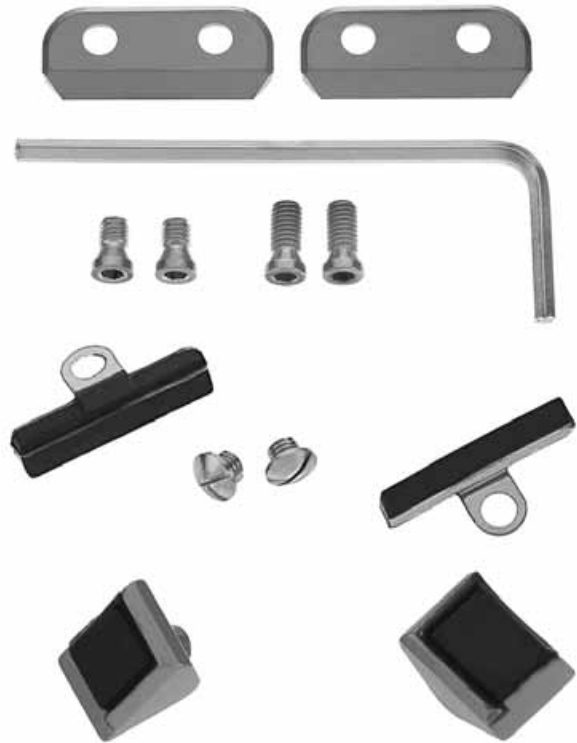

MARTIN Diamond Wire Cutter

OS3062

1.25mm capacity.
 Overall length
 6-1/2in (16.5cm).



Cannulated Pin Cutter

End cutting. Capacity 1.6mm.

OS3048

Overall length
 7-1/4in (18.4cm).



○ Instrument pictured

◆ Most widely used patterns

Wire Cutters/Probes

Coupe-fils/Sondes
Drahtschneider/Sonden
Tagliafili/Sonde
Cortaalambres/Sondas
Cortadores de fios/Sondas
ワイヤカッター/プローブ

Pin Cutters

End cutting.

OS3035-001

Capacity 3mm.
Overall length
10-1/4in (26cm).

OS3035-002

Capacity 4.7mm.
Overall length
14-3/4in (37.5cm).

OS3035-003

Capacity 6.3mm.
Overall length
22in (55.9cm).



Pin Cutter

Side cutting. Capacity 6.3mm.
Overall length 22-3/8in (56.8cm).

OS3030

OS3030-001

Removable handles.



BUNNELL Dissecting Probe

Angled.

OS5505

Overall length
5-1/2in (14cm).



BUNNELL Tendon Passers and Forwarding Probes

Polished finish.

OS5515

Overall length
7-3/8in (18.7cm).

OS5520

Overall length
8-7/8in (22.5cm).



Tendon Passers/Forceps

Dispositifs passe-tendon/Forceps
Sehnendurchzugsonden/Zangen
Passatendini/Pinze
Pasadores de tendones/Fórceps
Passadores de tendões/Fórceps
腱パッサー/鉗子

Tendon Passers

Overall length 6in (15.2cm).



◆ **OS5510**

Straight pointed tip.

OS5511

Curved pointed tip.



Tendon Braiding Forceps

Small size. Delicate, sharp point.
Single-pin tooth. Overall length
4-3/4in (12cm).

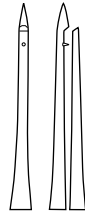

OS5512

Straight.

OS5513

Curved.



KLEINERT-KUTZ Tendon Retriever

Small size.



OS5524

Overall length
8-1/4in (21cm).



CAROLL Tendon Pulling Forceps

Curved. Serrated.



◆ **OS5521**

Overall length
5-1/2in (14cm).



BRAND Tendon Forceps

Angled.



OS5526-003

Overall length
7-1/2in (19cm).



BRAND Tendon Tunneling or Passing Forceps

Curved. Alligator-type.

OS5526-001

Overall length
6in (15.2cm).



OS5526-002

Overall length
9-1/4in (23.5cm).



Forceps/Tendon Strippers/Clamps

Forceps/Tringles de tendon/Clamps
Zangen/Sehnenstripper/Klemmen
Pinze/Scollatendini/Morse
Fórceps/Instrumentos para tendones/Pinzas
Fórceps/Separadores de tendões/Pinças
鉗子/腱剝離器/クランプ

Tendon Forceps

Straight, slender, with
2 x 3 delicate teeth.
Double-action.



OS5522

Overall length
8in (20.3cm).



BUNNELL Tendon Strippers

Overall length
6in (15.2cm).

OS5525-001

Size 1, tip 3mm wide.

OS5525-002

Size 2, tip 4mm wide.

OS5525-003

Size 3, tip 5mm wide.

OS5525-004

Size 4, tip 6mm wide.

OS5525-005

Size 5, tip 7mm wide.



Tendon Strippers

Flexible shaft.
Overall length
8-3/4in (22cm).

OS5610

4mm diameter.

OS5611

4.5mm diameter.

OS5612

5.5mm diameter.

OS5613

6mm diameter.

OS5614

7mm diameter.



Tendon Strippers

Autoclavable handle.

OS5622

3mm inner diameter.
Overall length
11in (28.5cm).

OS5603

6mm inner diameter.
Overall length
14in (35cm).

OS5607

6mm inner diameter.
Overall length
24in (60cm).

OS5600

3mm inner diameter.
Overall length
14in (35cm).

OS5604

3mm inner diameter.
Overall length
24in (60cm).

OS5601

4mm inner diameter.
Overall length
14in (35cm).

OS5605

4mm inner diameter.
Overall length
24in (60cm).

OS5620

5mm inner diameter.
Overall length
11in (28.5cm).

OS5602

5mm inner diameter.
Overall length
14in (35cm).

OS5621

5mm inner diameter.
Overall length
20in (50cm).

OS5606

5mm inner diameter.
Overall length
24in (60cm).



Meniscus Clamp

Curved shank.
1 x 2 teeth at tips of jaws.

◆ **OS5274**

Overall length
7-1/8in (18.1cm).



Clamps /Couteaux/Ciseaux
Klemmen/Messer/Scheren
Morse/Bisturi/Forbici
Pinzas /Cuchillos/Tijeras
Pinças/Facas/Tesoura
クランプ/ナイフ/鉏

MENISCUS Clamps (Slocum-Style)

Serrated. Overall length 5-3/8in (13.7cm).

OS5275-001

Straight.

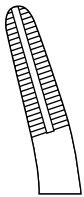

OS5275-002

Angled.



SMILLIE Meniscus Knives

Overall length 6-3/4in (17.1cm).

OS5211-001

Straight, chisel-type blade.

OS5211-002

Curved blade No. 1.

OS5211-003

Curved blade No. 2.

OS5212-001

Straight.

OS5212-002

Curved left.

OS5212-003

Curved right.

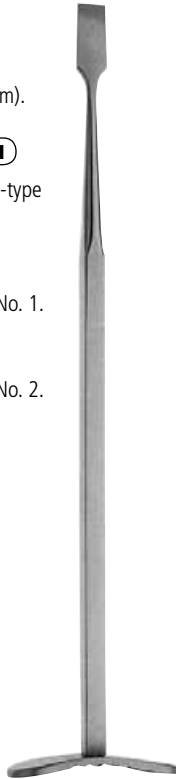

DOWNING Cartilage Knife

Aluminum handle.

OS5200

Overall length 9-3/8in (23.8cm).



MARTIN Cartilage Scissors

Curved, serrated blades, 5.3cm from mid-screw.

OS5241

Overall length 8in (20.3cm).

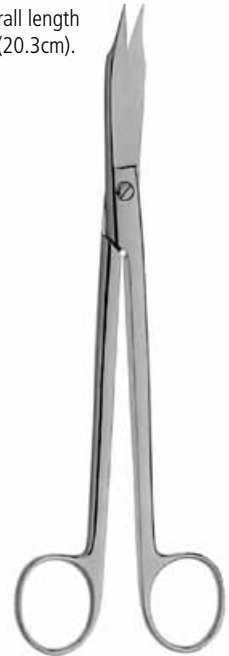

CRAIG Vertebral Body Biopsy Instrument Sets

The cannula hub is tapered to fit a Luer syringe. Matte and Mirror finish.



OS5000

Set includes:

Part No.	Description	Set Qty.
OS5000-001	CRAIG worm hook. Overall length 8-1/2in (21.6cm).	1
OS5000-002	CRAIG toothed cutters. Overall length 7-3/8in (18.7cm).	2
OS5000-003	CRAIG calibrated blunt trocars. Overall length 10in (25.4cm)	2
OS5000-004	CRAIG stylet pusher. Overall length 8-3/8in (21.3cm).	1
OS5000-005	CRAIG calibrated cannula. Overall length 5-3/8in (13.7cm).	1
OS5000-006	CRAIG needle and guard. 20GA.	1
OS5000-007	CRAIG needle and guard. 22GA.	1
OS5000-008	CRAIG socket wrench.	1
OS5000-009	CRAIG storage rack.	1

Individual components can be purchased separately

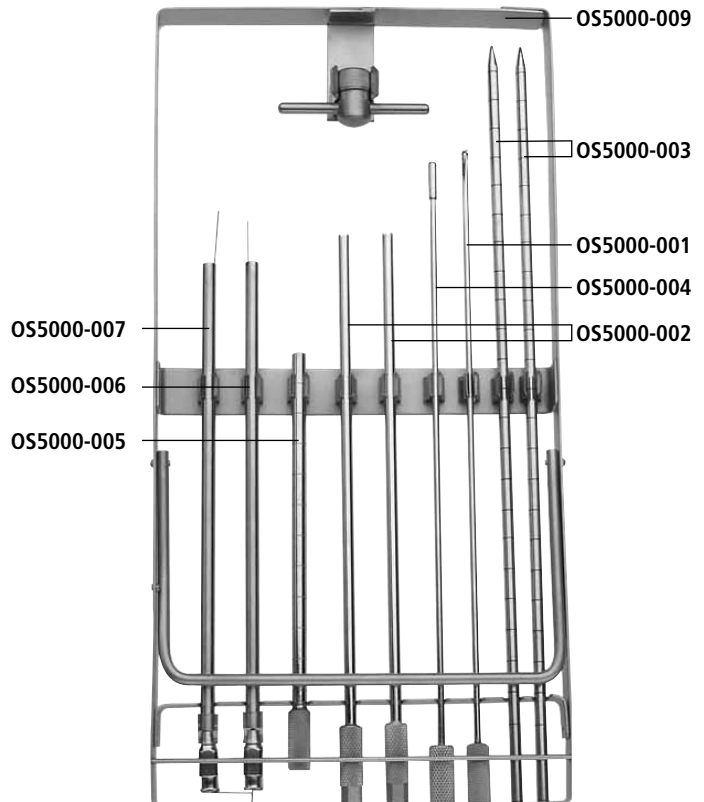

Trephines/Forceps/Scissors

Tréphines/Forceps/Ciseaux
 Trepanfräsen/Zangen/Scheren
 Fresa dentale/Pinze/Forbici
 Trepanadores/Fórceps/Tijeras
 Buris/Fórceps/Tesoura
 トレフィン/鉗子/鋏

MICHELE Trephines

Working length
 6-1/4in (15.9cm).
 Matte and Mirror finish.

OS5020-001

Small.
 Diameter 4.8mm.

OS5020-002

Medium.
 Diameter 5.5mm.

OS5020-003

Large.
 Diameter 7.9mm.

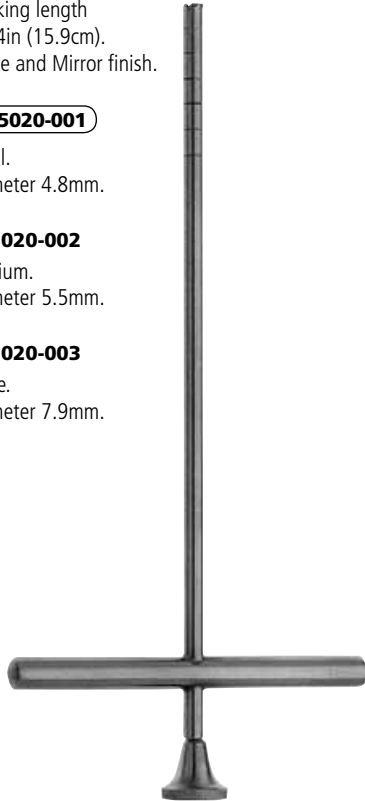

POLLEY-BICKEL Biopsy Trephine Set

Mirror and Satin finish.

OS5050



Ingrown Nail Forceps

Anvil-type.

◆ **OS3001**

Overall length
 5in (12.7cm).

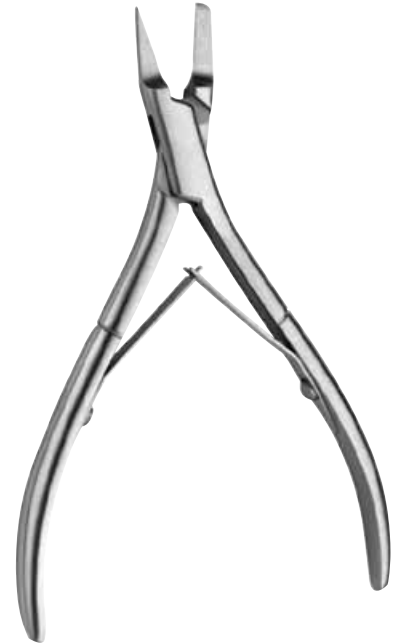

Platypus Nail Removing Forceps

Jaw 7mm wide.



OS3002

Overall length
 5-1/2in (14cm).



HERCULES Plaster Shears

OS6100

Overall length
 7-1/2in (19.1cm).



Utility Plaster Shears

Serrated.

OS6074

Overall length
 8in (20.3cm).



Ciseaux/Divers
 Scheren/Verschiedenes
 Forbici/Varie
 Tijeras/Varios
 Tesoura/Diversos
 鉋/その他

Heavy Duty Plaster Shears

OS6076

Esmarch-type.
 Probe point,
 angled on side.
 Overall length
 9in (22.9cm).



BRUNS Shears

Serrated.

OS6075

Overall length
 9-1/2in (24.1cm).



WALTON Cast Spreader

Serrated.

OS6085

Overall length
 9in (22.9cm).



HENNIG Cast Spreader

OS6060

Overall length
 10-7/8in (27.6cm).



Small Cast Remover



OS6081

Overall length
 7in (17.8cm).

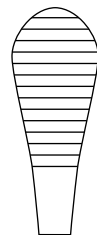

WOLFF-BOEHLER Cast Remover

OS6080

Overall length
 8in (20.3cm).



Calipers/Pin Vise/Drills

Pieds à coulisse/Porte-foret/Forets
Messschieber/Feilkloben/Bohrer
Estesiometri/Morsa per punte/Trapani
Calibres/Prensa de tornillo/Taladros
Pinças/Perfuradora manual/Brocas
キャリパー/ピン万力/ドリル

TOWNLEY Femur Caliper

◆ **OS2700**

Working length
4in (10cm).



STARRETT Pin Vise

For driving fine twist drills.
Has swivel finger rest on
proximal end for easier drilling.

◆ **OS5530**

Overall length
3in (7.6cm).



Customer Support

Our highly trained, centralized V. Mueller customer support team is available to take your calls from 7:00 a.m. to 6:00 p.m. (CST), M-F. This group is dedicated to providing a full range of support services, including:

- Order placement
- Order inquiries
- Delivery information
- Product information
- Pricing inquiries

If we can be of assistance, please call us at **800.323.9088**.

BUNNELL Hand Drill

Canulated to accommodate wires and small diameter drills.
Lightweight, with gears completely enclosed. JACOBS chuck key fits in handle.

◆ **OS5545**

5/32in (3.95mm).



Universal Rod Bender

◆ **OS3095**

Overall length
11-1/2in (29.2cm).



Quick Coupling Drill Bits

OS7000-011

Diameter 1.1mm.
Overall length 2-3/8in (6cm).

OS7000-015

Diameter 1.5mm.
Overall length 3-3/8in (8.5cm).

OS7000-020

Diameter 2.0mm.
Overall length 3-7/8in (10cm).

OS7000-025

Diameter 2.5mm.
Overall length 4-3/8in (11cm).

OS7000-027

Diameter 2.7mm.
Overall length 3-7/8in (10cm).

OS7000-033

Diameter 3.2mm.
Extra large thread.
Overall length 7-5/8in (19.5cm).

OS7000-032

Diameter 3.2mm.
Overall length 5-3/4in (14.5cm).

OS7000-035

Diameter 3.5mm.
Overall length 3-7/8in (10cm).

OS7000-036

Diameter 3.5mm.
Overall length 6-3/4in (17cm).

OS7000-045

Diameter 4.5mm.
Overall length 5-3/4in (14.5cm).

OS7000-060

Diameter 6.0mm.
Extra large thread.
Overall length 7-5/8in (19.5cm).



To learn how the IMPRESS system can help improve process performance, reduce immediate-use steam sterilization, decrease case delays, and improve patient care by monitoring instrument flow within your facility, contact your V. Mueller sales representative.

JACOBS Drill Bits

OS7010-011

Diameter 1.1mm.
Overall length 1-3/4in (4.5cm).

OS7010-027

Diameter 2.7mm.
Overall length 3-3/8in (8.5cm).

OS7010-015

Diameter 1.5mm.
Overall length 2-3/4in (7cm).

OS7010-020

Diameter 2mm.
Overall length 3-7/8in (10cm).

OS7010-025

Diameter 2.5mm.
Overall length 3-3/4in (9.5cm).

OS7010-033

Diameter 3.2mm.
Overall length 5-1/8in (13cm).

OS7010-032

Diameter 3.2mm.
Overall length 7-1/8in (18cm).

OS7010-035

Diameter 3.5mm.
Overall length 3-3/4in (9.5cm).

OS7010-036

Diameter 3.5mm.
Extra large thread.
Overall length 7-1/8in (18cm).

OS7010-045

Diameter 4.5mm.
Extra large thread.
Overall length 7-1/8in (18cm).

OS7010-060

Diameter 6mm.
Extra large thread.
Overall length 7-5/8in (19.5cm).



Fluted Drill Bits

Overall length 9in (23cm).

OS7020-025

Diameter 2.5mm.

OS7020-032

Diameter 3.2mm.

OS7020-045

Diameter 4.5mm.

Rulers/Corkscrew

Règles/Tire-bouchon
Lineale/Korkenzieher
Righe/Filo a spirale
Reglas/Sacacorchos
Régua/Ancoras em espiral
定規/コルクスクリュー

Screwdrivers

OS1791

Single slot.
Overall length 6-3/4in (17cm).

OS1775

Single slot.
Overall length 10in (25.4cm).

OS1779

Philips.
Overall length 10in (25.4cm).



K-Wire Ruler and Pin Gauge

OS2725

Overall length 6in (15.2cm).

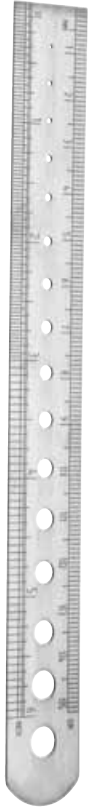

Flexible Ruler

Overall length 12in (30.5cm).

OS2730

13mm wide.



Metric Ruler

Deeply etched with accurate scales.

OP2720

Length 6in (15cm).



T-Handle Corkscrew

OS1544

Overall length 7-1/2in (19cm).





OS6200

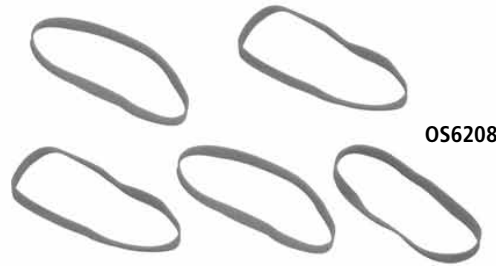

OS6208



OS6204

OS6203



OS6201



OS6205



OS6207

OS6206

TUPPER-Type Hand Table

Set includes 1 each of the following:

OS6220

Part No.	Description
OS6200	TUPPER-type hand table. Supports enough weight to withstand all passive torsion force of the supinated or pronated forearm. Numerous notches around the table's perimeter anchor the ball chains. 7 pairs of the slots for Sliding Hooks OS6207, 1 for each digit, arm and wrist. Faces 2 ways, for both left and right hand procedures.
OS6201	Elevated chain holders. Placed anywhere around Hand Table OS6200. Act as elevated anchor points for chains wherever clearance or an elevated pull above the flexed finger is necessary. 2 per package.
OS6202	Chain holder hooks. Allows 1 chain to serve as an anchor point for another chain. Aids in proximal retraction along the axis of the limb. 2 per package.
OS6205	Ball chains without hooks. Secures arm and wrist. Chains are attached to the table edge at each end. 2 per package.
OS6206	Tendon hooks. Facilitates the traumatic retraction of tendons and wound edges when attached to the hooks of OS6203 or OS6204. 4 per package.
OS6207	Sliding hooks. For rubber bands. Provide anchor points for Rubber Bands OS6208 when placed at any point along the slots.
OS6208	Rubber bands. Pulls digits downward at any point along their length. 5 per package.
OS6209	Carrying case. For table OS6200 and accessories. Stainless steel.
Ball Chains With Hooks	
For wound edge and fingertip retraction. Chains have an interval of 6cm and can be placed in the table edge, elevated chain holders or chain holder hooks.	
OS6204	Length 8-1/4in (21cm). 4 per package.
OS6203	Length 12-1/2in (32cm). 2 per package.

Optional accessory. Not included in set OS6220.

OS6210 Oval box. For accessories OS6201 through OS6208. 130mm x 8mm wide.

Bankart-Kolbel-Type Instruments

Instruments de type Bankart-Kolbel
 Bankart-Kölbel-Instrumente
 Strumenti tipo Bankart-Kolbel
 Instrumentos tipo Bankart-Kolbel
 Instrumentos do tipo Bankart-Kolbel
 Bankart-Kolbelタイプの器具

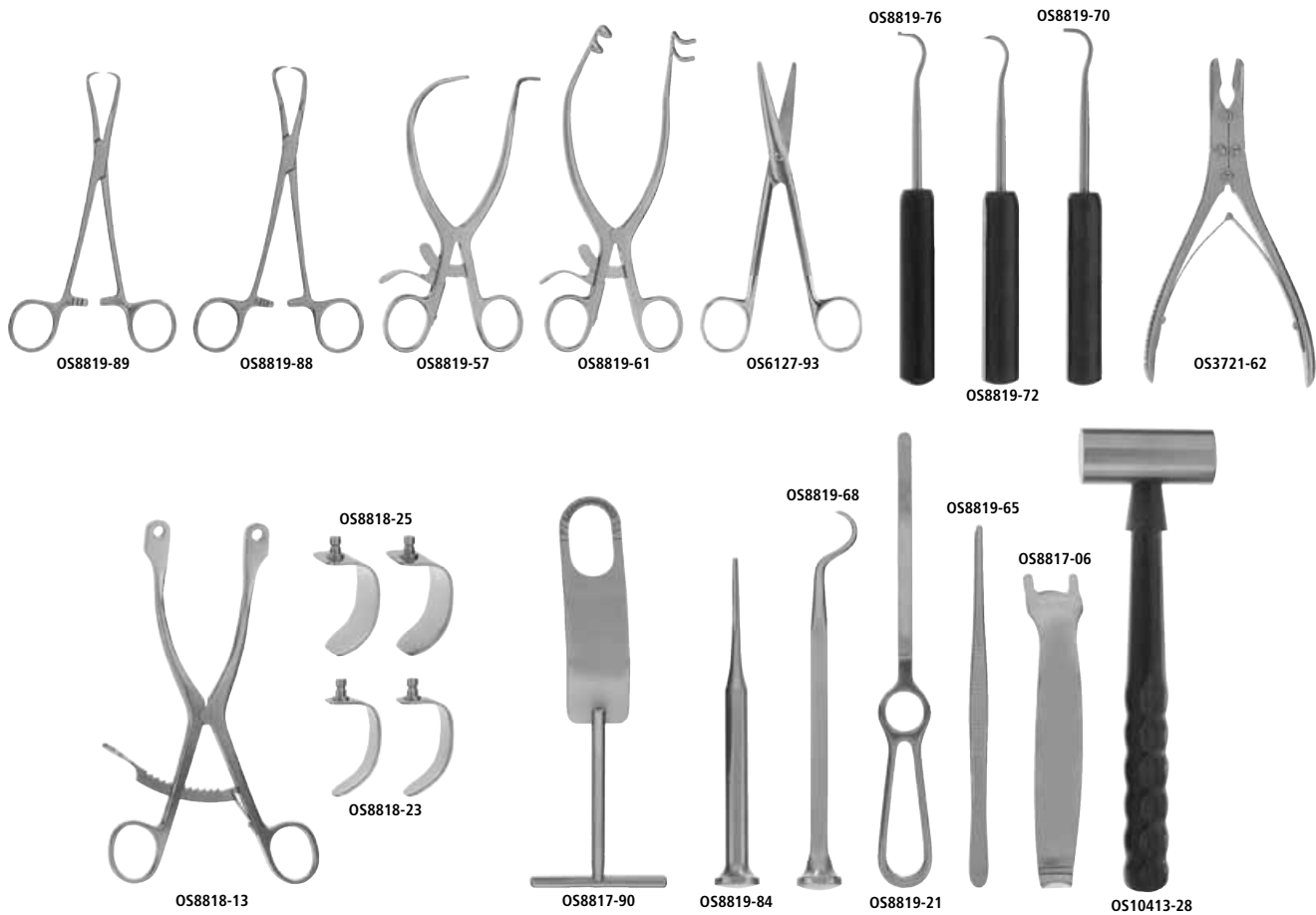

BANKART-KOLBEL-Type Standard Shoulder Repair Set

Components can be ordered separately. Set includes 1 each of the following:

OS1400

Part No.	Description
OS8819-84	Penetrating gouge. 3mm. Overall length 8-1/4in (21cm).
OS2931-15	RICHARDSON-type retractor. Blade 55mm x 22mm. Overall length 9-1/2in (24cm).
OS8819-61	Capsule spreader. Angled 90°. Overall length 6-1/8in (15.5cm).
OS8819-65	KOLBEL-type tissue forceps. Serrated. 1 x 2 teeth. Overall length 8-1/4in (21cm).
OS8819-68	Percussion awl. With metal handle. Overall length 8-5/8in (22.1cm).
OS8819-72	Penetrating awl. With phenolic handle. Overall length 7-1/4in (18.4cm).
OS8819-76	Crochet hook suture passer. Overall length 7-1/4in (18.4cm).
OS8819-70	Hollow lumen suture passer. Overall length 7-1/4in (18.4cm).
OS8819-88	Glenoid perforation forceps. Light angle. Overall length 6-3/4in (17.1cm).
OS8819-89	Glenoid perforation forceps. Strong angle. Overall length 6-3/4in (17.1cm).
OS8817-06	Humeral head retractor. Overall length 7in (17.8cm).

Part No.	Description
OS8819-31	KOLBEL-type glenoid lever. 15mm wide. Overall length 12in (30.5cm).
OS8819-33	KOLBEL-type glenoid lever. 20mm wide. Overall length 12in (30.5cm).
OS8817-93	Skid lever. Double-ended. Overall length 11in (27.9cm).
OS8819-57	KOLBEL-type soft tissue retractor. Angled. 2 x 2 prongs. Overall length 7in (17.8cm).
OS8818-13	KOLBEL-type retractor frame. Ring-handled. Overall length 8in (20.3cm).
OS8818-21	KOLBEL-type retractor blades. Pair. Blades 36mm x 36mm wide.
OS8818-23	KOLBEL-type retractor blades. Pair. Blades 53mm x 36mm wide.
OS8818-25	KOLBEL-type retractor blades. Pair. 68mm x 36mm wide.
OS8818-27	KOLBEL-type retractor blades. Pair. 85mm x 36mm wide.
OS10413-28	Mallet. Head 25mm. Overall length 9-1/2in (24.1cm).
OS3721-62	Bone nibbling rongeur. 5mm. Overall length 7-1/2in (19.1cm).
OS6127-93	Capsule and tendon scissors. Overall length 6-3/4in (17.1cm).

Instruments de type Bankart-Kolbel
 Bankart-Kölbel-Instrumente
 Strumenti tipo Bankart-Kolbel
 Instrumentos tipo Bankart-Kolbel
 Instrumentos do tipo Bankart-Kolbel
 Bankart-Kolbelタイプの器具

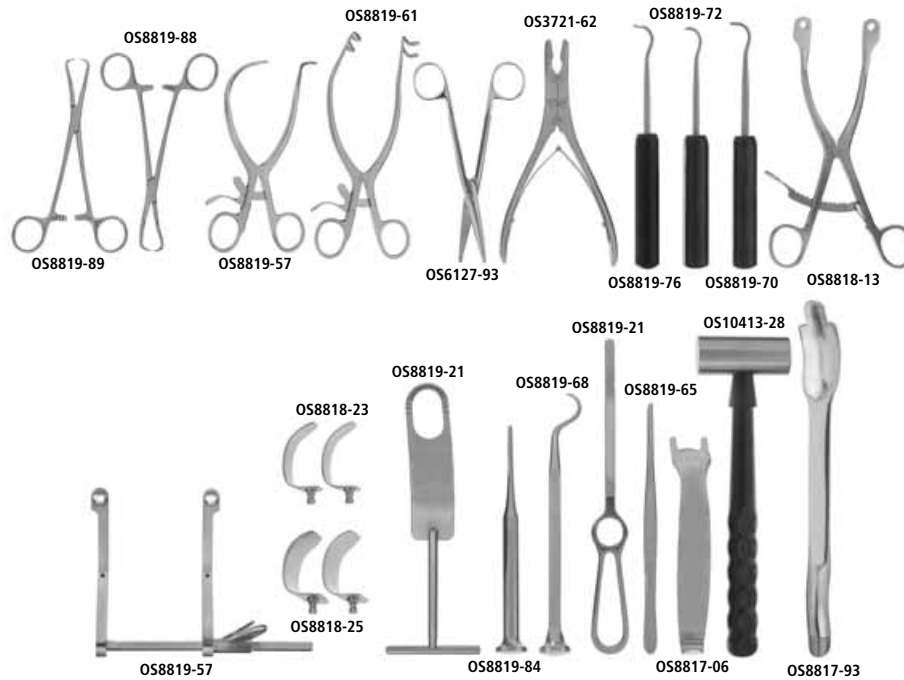

BANKART/KOLBEL-Type Expanded Repair Set

Components can be purchased separately. Set includes 1 each of the following:

OS1450

Part No.	Description
OS8819-84	Penetrating gouge. 3mm. Overall length 8-1/4in (21cm).
OS2931-15	RICHARDSON-type retractor. Blade 55mm x 22mm. Overall length 9-1/2in (24cm).
OS8819-61	Capsule spreader. Angled 90°. Overall length 6-1/8in (15.5cm).
OS8819-65	KOLBEL-type tissue forceps. Serrated. 1 x 2 teeth. Overall length 8-1/4in (21cm).
OS8819-68	Percussion awl. With metal handle. Overall length 8-5/8in (22.1cm).
OS8819-72	Penetrating awl. With phenolic handle. Overall length 7-1/4in (18.4cm).
OS8819-76	Crochet hook suture passer. Overall length 7-1/4in (18.4cm).
OS8819-70	Hollow lumen suture passer. Overall length 7-1/4in (18.4cm).
OS8819-88	Glenoid perforation forceps. Light angle. Overall length 6-3/4in (17.1cm).
OS8819-89	Glenoid perforation forceps. Strong angle. Overall length 6-3/4in (17.1cm).
OS8817-06	Humeral head retractor. Overall length 7in (17.8cm).
OS8819-31	KOLBEL-type glenoid lever. 15mm wide. Overall length 12in (30.5cm).
OS8819-33	KOLBEL-type glenoid lever. 20mm wide. Overall length 12in (30.5cm).
OS8817-93	Skid lever. Double-ended. Overall length 11in (27.9cm).
OS8819-57	KOLBEL-type soft tissue retractor. Angled. 2 x 2 prongs. Overall length 7in (17.8cm).
OS8818-13	KOLBEL-type retractor frame. Ring handled. Overall length 8in (20.3cm).
OS8818-21	KOLBEL-type retractor blades. Pair. Blades 36mm x 36mm wide.
OS8818-23	KOLBEL-type retractor blades. Pair. Blades 53mm x 36mm wide.

Part No.	Description
OS8818-25	KOLBEL-type retractor blades. Pair. Blades 68mm x 36mm wide.
OS8818-27	KOLBEL-type retractor blades. Pair. Blades 85mm x 36mm wide.
OS8818-15	KOLBEL-type retractor blades. Pair. Blades 36mm x 20mm wide.
OS8818-16	KOLBEL-type retractor blades. Pair. Blades 53mm x 20mm wide.
OS8818-17	KOLBEL-type retractor blades. Pair. Blades 68mm x 20mm wide.
OS8818-18	KOLBEL-type retractor blades. Pair. Blades 85mm x 20mm wide.
OS8818-12	KOLBEL-type retractor frame. Crank-style.
OS8819-21	DARRACH-type acromonial lever. 9mm x 260mm wide.
OS8819-23	DARRACH-type acromonial lever. 12mm x 260mm wide.
OS8819-25	DARRACH-type acromonial lever. 18mm x 260mm wide.
OS8819-27	DARRACH-type acromonial lever. 25mm x 260mm wide.
OS8817-90	KUJAT-FUKUDA-type humeral head retractor. Overall length 9in (22.9cm).
OS10413-28	Mallet. Head 25mm. Overall length 9-1/2in (24.1cm).
OS3721-62	Bone nibbling rongeur. 5mm. Overall length 7-1/2in (19.1cm).
OS6127-93	Capsule and tendon scissors. Overall length 6-3/4in (17.1cm).

Optional component for OS1400 and OS1450 (not included in set):

OS8149-56 Chisel system. With handle and three blades.

○ Instrument pictured

◆ Most widely used patterns

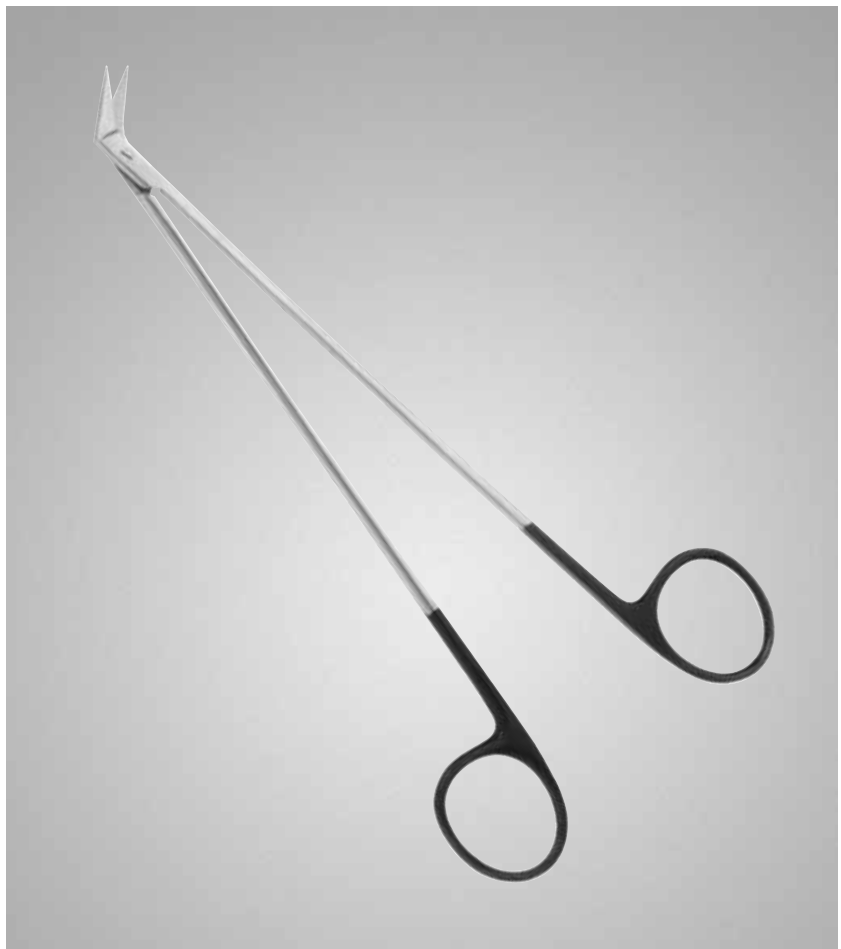
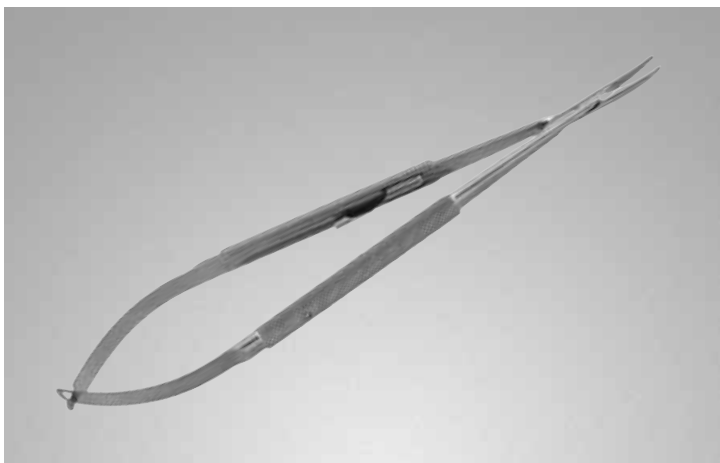
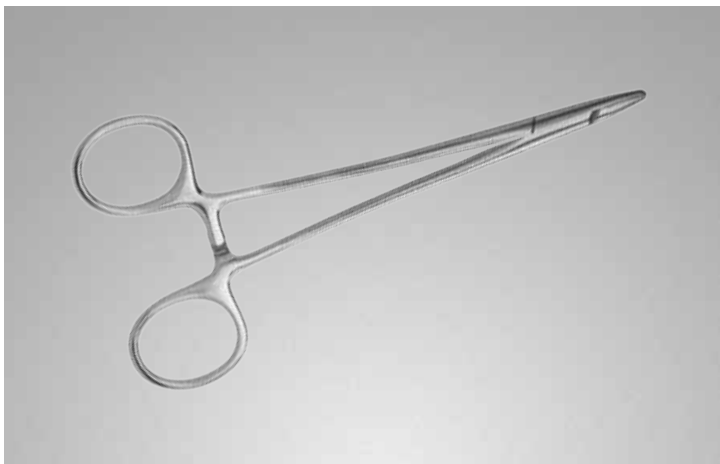
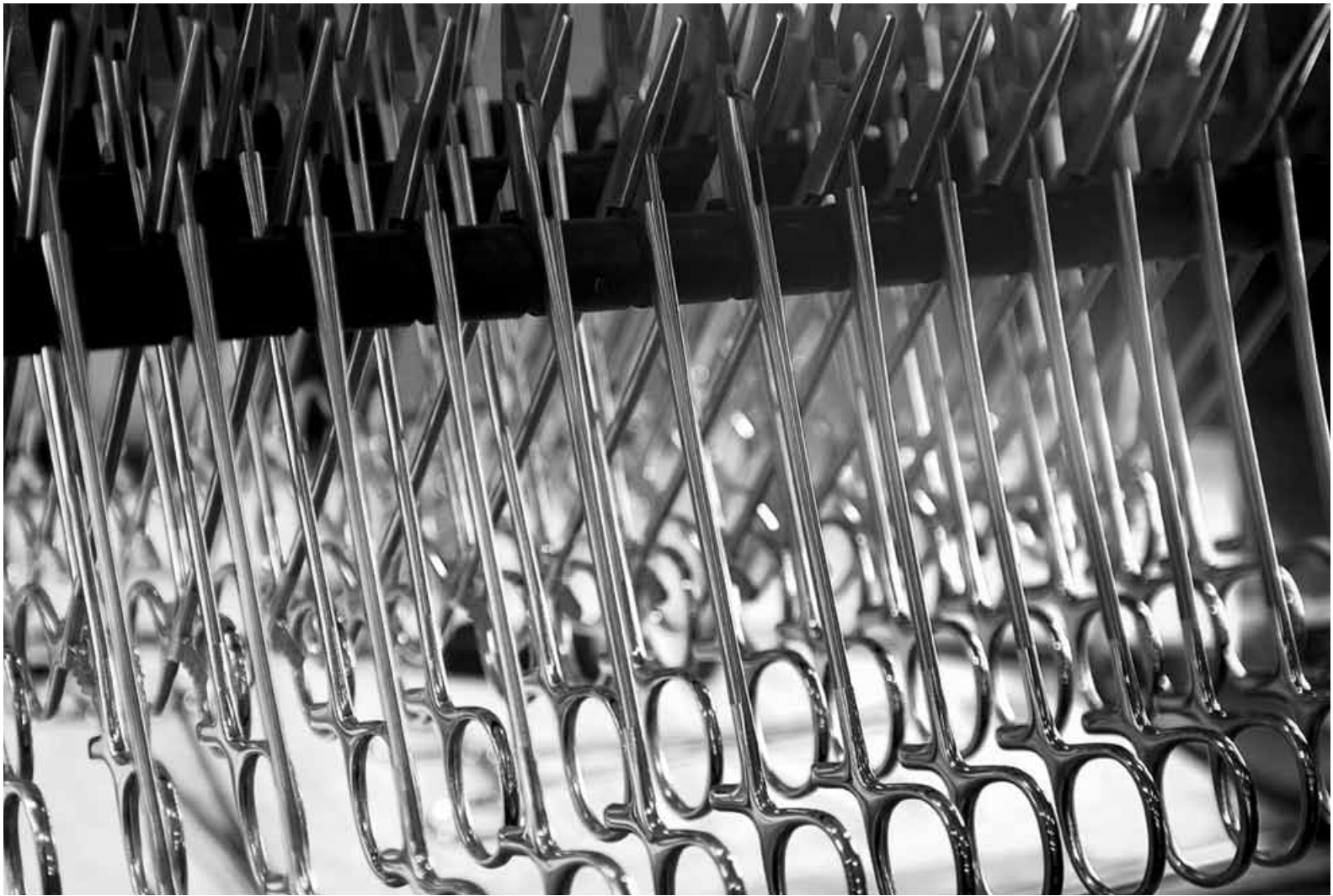

Neuro/Spine and Orthopedic Instruments

Curettes, Kerrison Ronguers, Shadow-Line
and McCulloch Retraction Sets

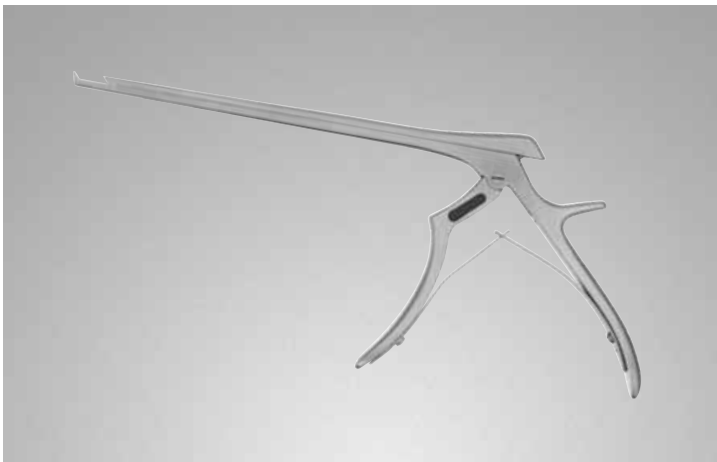

Retractors

Écarteurs
Wundspreizer/Retraktoren
Divaricatori
Separadores
Retradores
リトラクター

MEYERDING Retractors

Overall length
7-7/8in (20cm).

NL5385

Blades
2-3/8in x 1in
(6cm x 2.5cm).

NL5386

Blades
2-1/8in x 1in
(5.4cm x 2.5cm).

NL5387

Blades
1-3/4in x 1in
(4.4cm x 2.5cm).



MARKHAM-MEYERDING Retractors

Self-retaining. Blade 2in x 1in (5.1cm x 2.5cm) wide.
Overall length 7-1/2in (19cm).

NL5382

Blade on right.
Sharp tenaculum on left.

NL5383

Blade on left.
Sharp tenaculum on right.



WILLIAMS-Style Discectomy Retractors

Narrow. Overall length 7in (17.8cm).



Right Hook	Left Hook	Blade Size (length x width)
NL5390-002	NL5390-006	50mm x 20mm
NL5390-003	NL5390-007	60mm x 20mm
NL5390-004	NL5390-008	70mm x 20mm
NL5391-002	NL5391-006	50mm x 10mm
NL5391-003	NL5391-007	60mm x 10mm
NL5391-004	NL5391-008	70mm x 10mm

Micro Spine Retractors

Overall length 7in (18cm).

B-0200

Blade 50mm x 10mm wide. Left.

B-0201

Blade 50mm x 10mm wide. Right.

B-0202

Blade 60mm x 10mm wide. Left.

B-0203

Blade 60mm x 10mm wide. Right.

B-0204

Blade 70mm x 10mm wide. Left.

B-0205

Blade 70mm x 10mm wide. Right.

B-0206

Blade 50mm x 20mm wide. Left.

B-0207

Blade 50mm x 20mm wide. Right.

B-0208

Blade 60mm x 20mm wide. Left.

B-0209

Blade 60mm x 20mm wide. Right.

B-0210

Blade 70mm x 20mm wide. Left.

B-0211

Blade 70mm x 20mm wide. Right.



BECKMAN-ADSON Retractors

Overall length
12in (30cm).
4 x 4 prongs.

◆ **NL5400**

Prongs 25mm x 25mm. Sharp.

B-0103

Prongs 25mm x 44mm. Blunt.

B-0104

Prongs 25mm x 44mm. Sharp.

B-0105

Prongs 25mm x 25mm. Blunt.



BECKMAN-ADSON Spine Retractor

Overall length
10in (25.5cm).
3 x 4 prongs.

◆ **B-0100**

Sharp prongs.



Retractors

Écarteurs
Wundspreizer/Retraktoren
Divaricatori
Separadores
Retratores
リトラクター

CLOWARD Cervical Retractors Set

Blunt. Includes 7 pairs of toothed blades from 25mm to 55mm.
Overall length 6-3/4in (17.2cm). Set includes the following:

NL5244

Part No.	Description	Quantity
NL5245	Hinged retractor frame 6-3/4in (17.2cm)	1 Each
NL5244-25	25mm blades	2 Each
NL5244-30	30mm blades	2 Each
NL5244-35	35mm blades	2 Each
NL5244-40	40mm blades	2 Each
NL5244-45	45mm blades	2 Each
NL5244-50	50mm blades	2 Each
NL5244-55	55mm blades	2 Each



CLOWARD Cervical Retractor Set

Sharp. Includes 7 pairs of toothed blades from 25mm to 55mm.
Overall length 10in (25.4cm). Set includes the following:

NL5241

Part No.	Description	Quantity
NL5242	Hinged Retractor Frame 10in (25.4cm)	1 Each
NL5243-25	25mm blades	2 Each
NL5243-30	30mm blades	2 Each
NL5243-35	35mm blades	2 Each
NL5243-40	40mm blades	2 Each
NL5243-45	45mm blades	2 Each
NL5243-50	50mm blades	2 Each
NL5243-55	55mm blades	2 Each



CLOWARD Retractor Frame

Hinged.

NL5242

Overall length
10in (25.4cm).

NL5245

Overall length
6-3/4in (17.2cm).

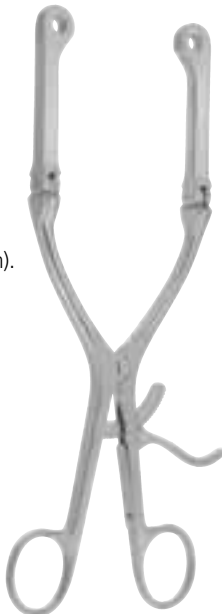

CLOWARD Blades

Sold separately.

Blunt	Toothed Blades		Blade Width
	Sharp	Prongs	
NL5244-25	NL5243-25		25mm
NL5244-30	NL5243-30		30mm
NL5244-35	NL5243-35		35mm
NL5244-40	NL5243-40		40mm
NL5244-45	NL5243-45		45mm
NL5244-50	NL5243-50		50mm
NL5244-55	NL5243-55		55mm
NL5244-60	NL5243-60		60mm



OBERHILL Retractor

Self-retaining, with ratchet catch.
Adjustable swivel arms have
4-pronged blades
25mm x25mm wide.

NL5412

Overall length
12-1/4in (31.1cm).



BECKMAN-EATON Retractor

Self-retaining, with ratchet catch.
Adjustable swivel arms have
7-pronged blades
51mm x 45mm wide.

NL5410

Overall length
12-5/8in (32cm).



SCOVILLE Retractors

With 1 blunt hook blade, 2in (5.1cm) deep (NL5240-001) and
1 HIBBS-type blade, 4in deep x 2in wide (10.2cm x 5.1cm) (NL5240-026).
Arm 6in x 8in (15.2cm x 20.3cm) wide.

NL5237

NL5238

Retractor body only.



HAVERFIELD-SCOVILLE Retractors

Hinged arms 6in x 8in (15.2cm x 20.1cm) wide.

NL5239

With 2 blades, 4in x 2in (10.2cm x 5.1cm) wide.

NL5239-001

Retractor body only.



Retractor Blades

Larmes d'écarteur
Wundspreizerblätter
Lame divaricatore
Cuchillas de separadores
Lâminas de retrator
リトラクターのブレード

HIBBS-Type Blades

Angled 90°.

NL5240-015

2in x 1in
(5.1cm x 2.5cm) wide.

NL5240-026

4in x 2in
(10.2cm x 5.1cm) wide.

NL5240-017

2-1/2in x 1in
(6.4cm x 2.5cm) wide.

NL5240-018

2-1/2in x 1-1/2in
(6.4cm x 3.8cm) wide.

NL5240-019

3in x 1in
(7.6cm x 2.5cm) wide.

NL5240-020

3in x 1-1/2in
(7.6cm x 3.8cm) wide.

NL5240-021

3in x 2in
(7.6cm x 5.1cm) wide.

NL5240-022

3in x 2-1/2in
(7.6cm x 6.4cm) wide.

NL5240-023

3-1/2in x 1in
(8.9cm x 2.5cm) wide.

NL5240-025

4in x 1in
(10.2cm x 2.5cm) wide.



SCOVILLE Blade

4 prongs, angled 90°.



NL5240-011

1-1/2in x 1-5/8in
(3.8cm x 4.1cm) wide.

SCOVILLE Blunt Hooks

Angled 90°.

NL5240-001

Working length 2-1/4in (5.7cm).

NL5240-002

Working length 3-1/4in (8.3cm).

NL5240-003

With arm. Working length 2-1/2in (6.4cm).

NL5240-004

With arm. Working length 3-1/2in (8.9cm).



TAYLOR-Type Blades

4 prongs, angled 90°, 2in (5.1cm) wide.

NL5240-008

Blade length 1-7/8in (4.8cm).

NL5240-009

Blade length 2-1/2in (6.4cm).



Larmes d'écarteur/Râteaux
 Wundspreizerblätter/Spreizer
 Lame divaricatore/Divaricatori
 Cuchillas de separadores/Espátulas
 Lâminas de retrator/Afastadores
 リトラクターのブレード/スプレッター

MEYERDING-Type Laminectomy Blades

NL5240-027

2-1/4in x 1in
 (5.7cm x 2.5cm) wide.

NL5240-028

3in x 1in
 (7.6cm x 2.5cm) wide.

NL5240-029

3-1/2in x 2in
 (8.9cm x 5.1cm) wide.



TAYLOR-Type Spinal Retractor Blade

NL5240-031

4in x 1-3/4in
 (10.2cm x 4.4cm) wide.



V. Mueller Instrument Warranty

We warranty every medical device and accessory bearing the V. Mueller brand name to be free of functional defects in workmanship and materials when used normally for its intended use. Any V. Mueller product proving to be so defective will be replaced or repaired at no charge. Repairs or modifications performed by unauthorized personnel may void all product warranties and could affect performance and efficacy of the device.

INGE Lamina Spreaders



◆ **OS1316**

Overall length
 6-1/2in (16.5cm).

OS1315

Without teeth.
 Overall length
 6-1/2in (16.5cm).

◆ **OS1317**

Overall length
 10in (25.4cm).

OS1314

With calibrated bar.
 Overall length
 10in (25.4cm).



Retractors

Écarteurs
Wundspreizer/Retraktoren
Divaricatori
Separadores
Retradores
リトラクター

SCOVILLE Nerve Root Retractor

Straight. Tip 1/4in (6.4mm) wide.



NL5760

Overall length
8-3/4in (22.2cm).



LOVE Nerve Retractor

Shank length 4in (10.2cm).



NL5800

Angled.

E-0576

Angled 135°.
Blade width 6mm.

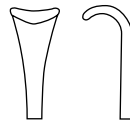

NL5750

Straight.
Blade 6.75mm wide.

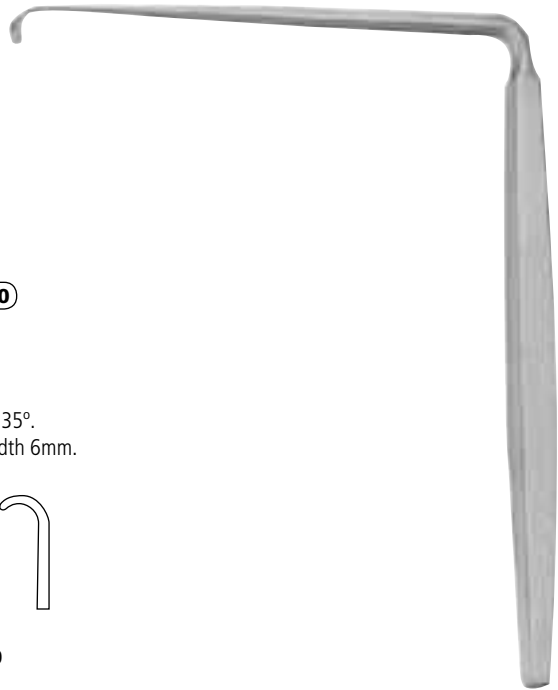

Looking for a specific product?

When you know the catalog number or the name of the product you need, you can use the index at the end of this book to direct you to the page on which the product is described. If you do not find the specific instruments you are looking for, please contact your local V. Mueller sales representative or Customer Support at **800.323.9088**.



D'ERRICO Nerve Retractor

Bayonet shank.
Curved blade end,
7.9mm wide.



NL5770

Overall length
9in (22.9cm).



HOLSCHER Nerve Root Retractors

Overall length 9-1/2in (24.1cm).

NL5755-6

Blade 6mm wide.

NL5755-13

Blade 12mm wide.



SCOVILLE Nerve Root Retractor

Angled.



NL5810

Shank length
4-1/4in (10.8cm).



MCCULLOCH Nerve Root Retractors

Blade 6mm wide.

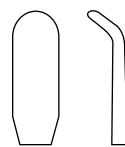

NL9703

Shaft length
5in (12.7cm).

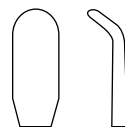

NL9703-001

Extra-long shaft.
Shaft length 6in (15.2cm).

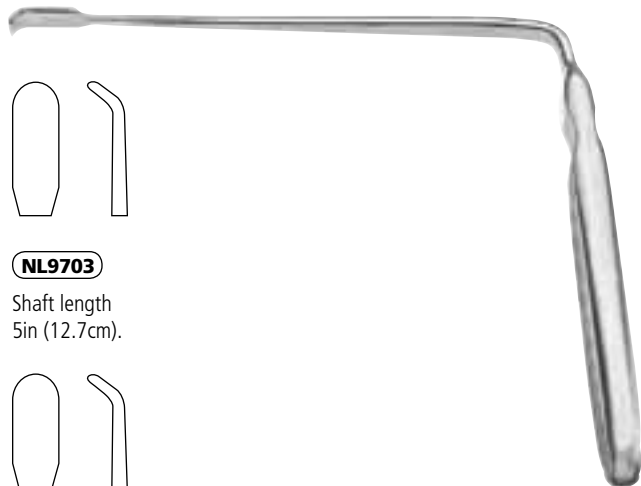

Kerrisons/Rongeurs

Kerrisons/Pinces-gouges
 Kerrison-Rongeur/Rongeur
 Kerrison/Pinze ossivore
 Gubias Kerrison/Gubias
 Pinças Kerrison/Saca-bocados
 Kerrisons/骨鉗子

RANEY Rongeur Forceps

Up-cutting bite. Shaft length 6in (15.2cm).

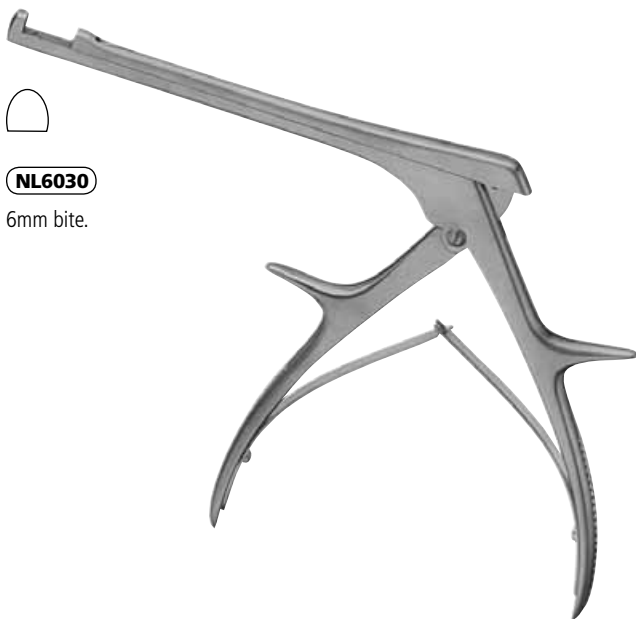

NL6030

6mm bite.

LOVE-KERRISON Rongeur Forceps

Shaft length 6in (15.2cm).

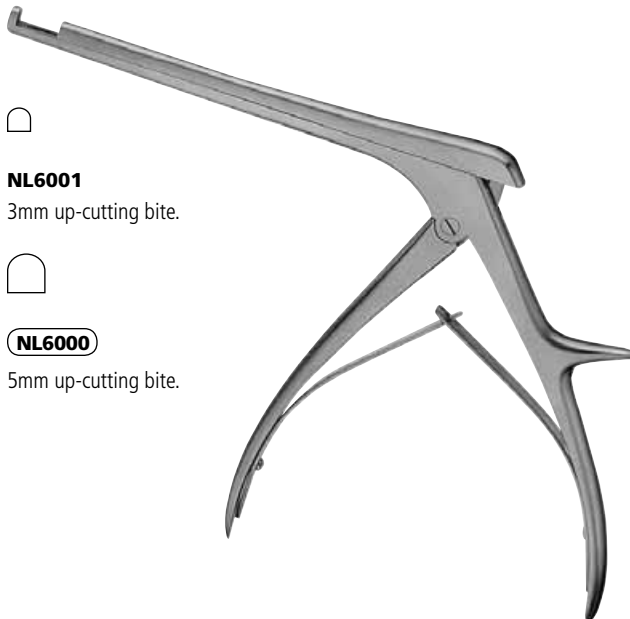

NL6001

3mm up-cutting bite.



NL6000

5mm up-cutting bite.

SPURLING-KERRISON Rongeur Forceps

Up-cutting bite. Jaw opening 15mm.



3mm

4mm

5mm

6mm

SPURLING-KERRISON Rongeur Forceps

Down-cutting bite. Jaw opening 15mm.

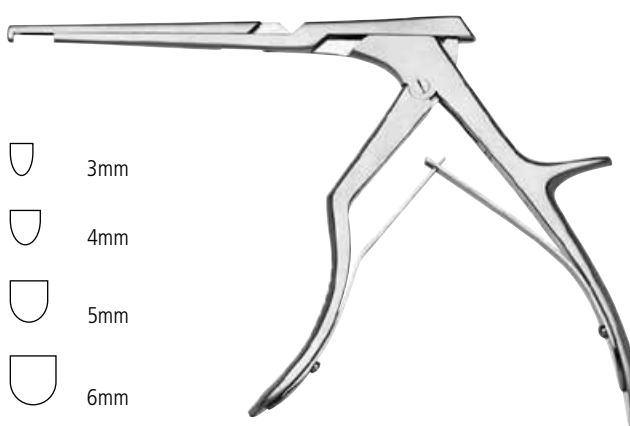

3mm

4mm

5mm

6mm

Straight	Angled 40°	Bite Size	Shaft Length
NL6011	NL6035	3mm	6in (15.2cm)
NL6012		4mm	6in (15.2cm)
NL6013	NL6036	5mm	6in (15.2cm)
NL6014		6mm	6in (15.2cm)
NL6020	NL6037	3mm	8in (20.3cm)
NL6021		4mm	8in (20.3cm)
NL6022	NL6038	5mm	8in (20.3cm)

Part No.	Bite Size	Shaft Length
NL6016	3mm	6in (15.2cm)
NL6017	4mm	6in (15.2cm)
NL6018	5mm	6in (15.2cm)
NL6019	6mm	6in (15.2cm)
NL6024	3mm	8in (20.3cm)

Kerrisons/Pinces-gouges
 Kerrison-Rongeur/Rongeur
 Kerrison/Pinze ossivore
 Gubias Kerrison/Gubias
 Pinças Kerrison/Saca-bocados
 Kerrisons/骨鉗子

FERRIS-SMITH-KERRISON Rongeur Forceps

Shaft length 7in (17.8cm).

NL6044

Up-cutting bite,
 3mm, angled 40°.



SPURLING-KERRISON Rongeurs

40° up-cutting. Shaft length 8in (20.3cm).

◻

NL4291-082

2mm cup.

◻

NL4291-083

3mm cup.

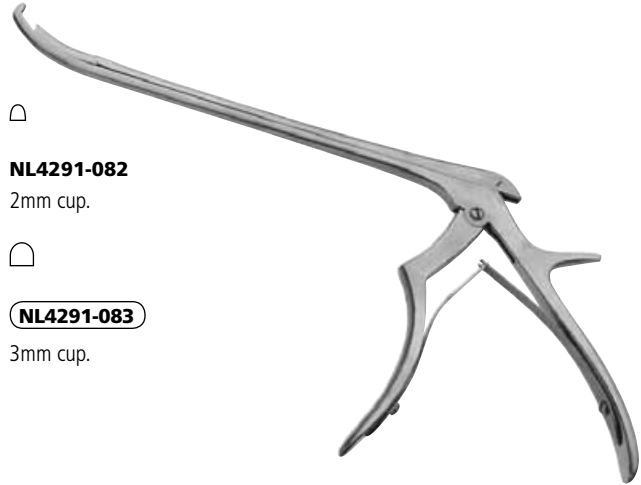

DAWSON-YUHL-KERRISON Rongeur Forceps

Working length 11in (27.9cm).

NL7100-048

Jaws 5mm x 3mm wide, angled 40°.

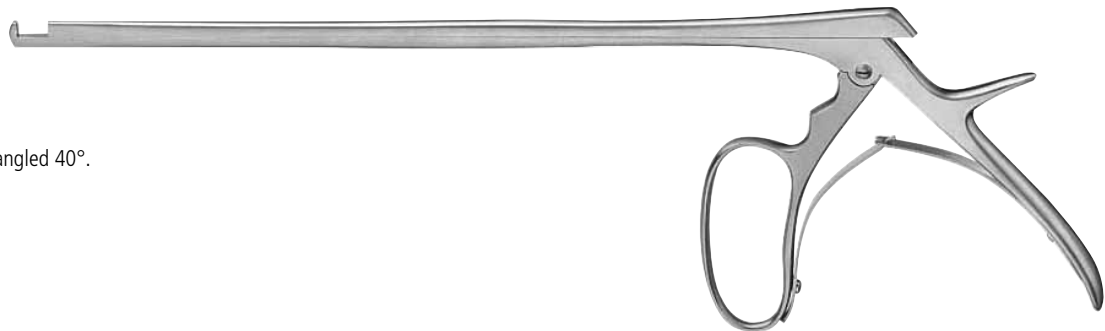

Kerrisons/Rongeurs

Kerrisons/Pinces-gouges
 Kerrison-Rongeur/Rongeur
 Kerrison/Pinze ossivore
 Gubias Kerrison/Gubias
 Pinças Kerrison/Saca-bocados
 Kerrisons/骨鉗子

FERRIS SMITH-KERRISON Rongeurs



90° Angle Up-cutting	40° Angle Up-cutting	Bite Size	Shaft Length
	NL4281-062	2mm	6in (15.2cm)
	NL4281-063	3mm	6in (15.2cm)
	NL4281-064	4mm	6in (15.2cm)
	NL4281-065	5mm	6in (15.2cm)
	NL4281-072	2mm	7in (17.8cm)
	NL4281-073	3mm	7in (17.8cm)
	NL4281-074	5mm	7in (17.8cm)
	NL4281-075	5mm	7in (17.8cm)
	NL4281-076	6mm	7in (17.8cm)
NL4280-082	NL4281-082	2mm	8in (20.3cm)
NL4280-083	NL4281-083	3mm	8in (20.3cm)
NL4280-084	NL4281-084	4mm	8in (20.3cm)
NL4280-085	NL4281-085	5mm	8in (20.3cm)
	NL4281-086	6mm	8in (20.3cm)
	NL4281-112	2mm	11in (27.9cm)
	NL4281-113	3mm	11in (27.9cm)
	NL4281-114	4mm	11in (27.9cm)
	NL4281-115	5mm	11in (27.9cm)
	NL4281-116	6mm	11in (27.9cm)

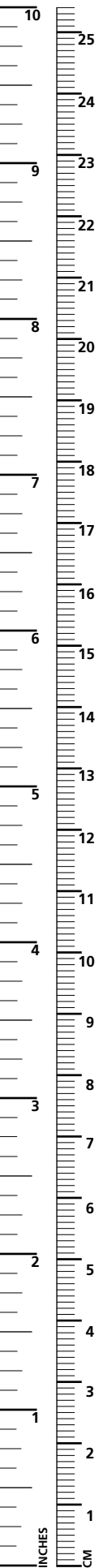

Micro Handle KERRISON Rongeurs

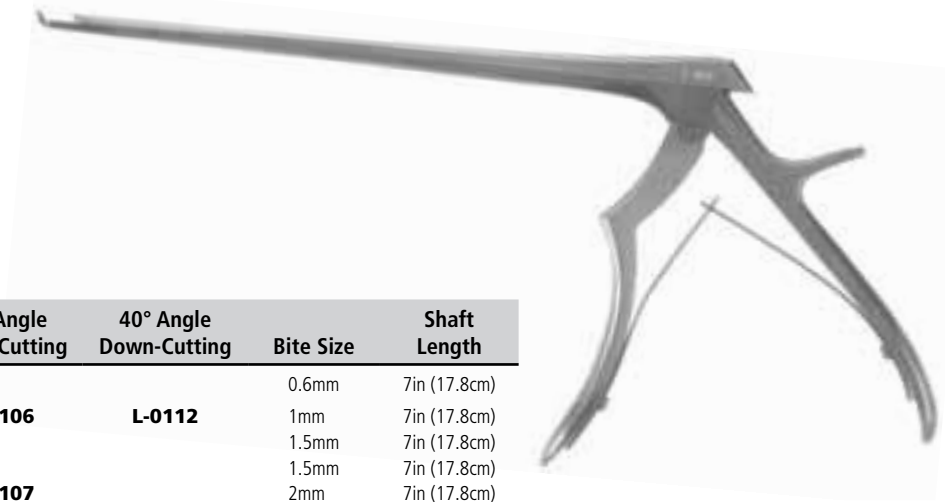

90° Angle Up-Cutting	40° Angle Up-Cutting	90° Angle Down-Cutting	40° Angle Down-Cutting	Bite Size	Shaft Length
L-0070	L-0080			0.6mm	7in (17.8cm)
L-0099		L-0106	L-0112	1mm	7in (17.8cm)
L-0071	L-0111			1.5mm	7in (17.8cm)
				1.5mm	7in (17.8cm)
L-0100		L-0107		2mm	7in (17.8cm)
L-0101		L-0108		3mm	7in (17.8cm)
L-0102				4mm	7in (17.8cm)
L-0103		L-0110		5mm	7in (17.8cm)
L-0119			L-0128	1mm	8in (20.3cm)
L-0120		L-0124		2mm	8in (20.3cm)
L-0121		L-0125		3mm	8in (20.3cm)
L-0122		L-0126		4mm	8in (20.3cm)
L-0123		L-0127		5mm	8in (20.3cm)

SPURLING-KERRISON Rongeurs

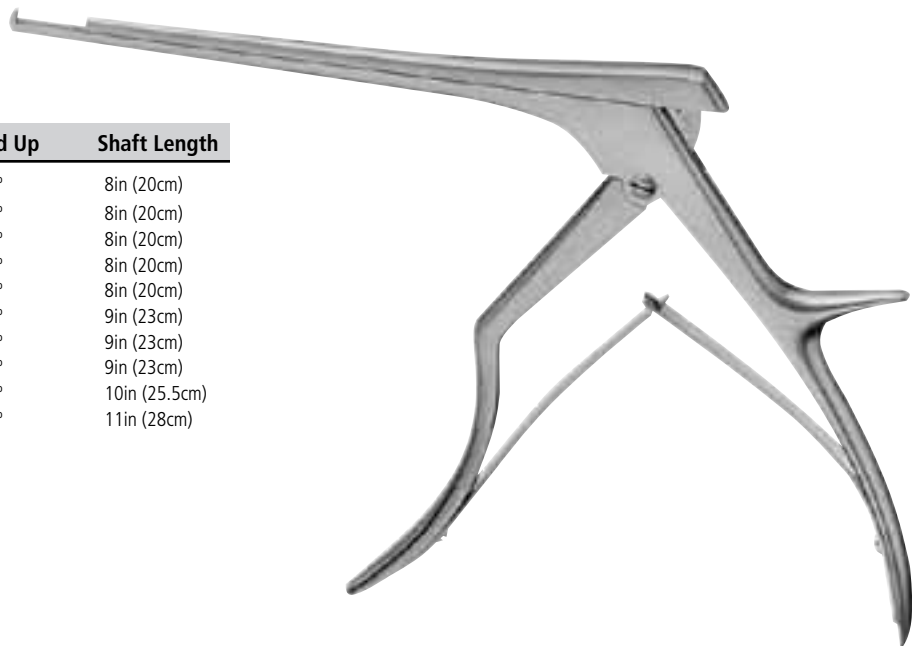

Part No.	Bite Size	Angled Up	Shaft Length
L-0172	5mm	90°	8in (20cm)
L-0178	2mm	40°	8in (20cm)
L-0179	3mm	40°	8in (20cm)
L-0180	4mm	40°	8in (20cm)
L-0181	5mm	40°	8in (20cm)
L-0184	2mm	40°	9in (23cm)
L-0185	3mm	40°	9in (23cm)
L-0186	4mm	40°	9in (23cm)
L-0194	2mm	40°	10in (25.5cm)
L-0192	4mm	40°	11in (28cm)

Kerrisons/Rongeurs

Kerrisons/Pinces-gouges
 Kerrison-Rongeur/Rongeur
 Kerrison/Pinze ossivore
 Gubias Kerrison/Gubias
 Pinças Kerrison/Saca-bocados
 Kerrisons/骨鉗子

T-COAT® Micro-Handle KERRISON Rongeurs

40° up-cutting. Titanium-coated.



Shaft Length 7in (17.8cm)	Shaft Length 8in (20.3cm)	Shaft Length 9in (22.9cm)	Shaft Length 10in (25.4cm)	Shaft Length 11in (27.9cm)	Shaft Length 12in (30.5cm)	Bite Size	Bite Opening
◆ NL4251-71T	NL4251-81T	NL4251-91T	NL4251-01T		NL4251-21T	1mm	10mm
NL4251-72T	NL4251-82T	NL4251-92T	NL4251-02T		NL4251-22T	2mm	10mm
NL4251-73T	NL4251-83T	NL4251-93T	NL4251-03T		NL4251-23T	3mm	10mm
NL4251-74T	NL4251-84T	NL4251-94T	NL4251-04T		NL4251-24T	4mm	10mm
NL4251-75T	NL4251-85T	NL4251-95T	NL4251-05T		NL4251-25T	5mm	10mm
NL4251-76T	NL4251-86T	NL4251-96T			NL4251-26T	6mm	10mm
NL4255-71T	NL4255-81T	NL4255-91T	NL4255-01T	NL4255-11T	NL4255-21T	1mm	15mm
	NL4255-82T	NL4255-92T		NL4255-12T	NL4255-22T	2mm	15mm
NL4255-73T	NL4255-83T	NL4255-93T		NL4255-13T	NL4255-23T	3mm	15mm
NL4255-74T	NL4255-84T	NL4255-94T	NL4255-04T	NL4255-14T	NL4255-24T	4mm	15mm
NL4255-75T	NL4255-85T	NL4255-95T		NL4255-15T	NL4255-25T	5mm	15mm
					NL4255-26T	6mm	15mm

With Ejector

NL4253-72T	NL4253-82T	NL4253-92T	NL4253-02T		NL4253-22T	2mm	10mm
NL4253-73T	NL4253-83T	NL4253-93T	NL4253-03T		NL4253-23T	3mm	10mm
NL4253-74T	NL4253-84T	NL4253-94T	NL4253-04T		NL4253-24T	4mm	10mm
NL4253-75T	NL4253-85T	NL4253-95T	NL4253-05T		NL4253-25T	5mm	10mm
NL4253-76T	◆ NL4253-86T	NL4253-96T				6mm	10mm
NL4256-72T	NL4256-82T	NL4256-92T		NL4256-12T		2mm	15mm
NL4256-73T	NL4256-83T	NL4256-93T	NL4256-03T	NL4256-13T		3mm	15mm
NL4256-74T	NL4256-84T	NL4256-94T		NL4256-14T	NL4256-24T	4mm	15mm
NL4256-75T	NL4256-85T	NL4256-95T		NL4256-15T		5mm	15mm
		NL4256-96T				6mm	15mm

Thin Foot Plate

	NL4252-81T	NL4252-91T				1mm	10mm
	NL4252-82T	NL4252-92T				2mm	10mm
	NL4252-83T	NL4252-93T				3mm	10mm
	NL4252-84T	NL4252-94T				4mm	10mm
	◆ NL4252-85T	NL4252-95T				5mm	10mm
	NL4252-86T	NL4252-96T				6mm	10mm
NL4257-71T	NL4257-81T	NL4257-91T		NL4257-11T		1mm	15mm
NL4257-72T	NL4257-82T	NL4257-92T		NL4257-12T		2mm	15mm
NL4257-73T	NL4257-83T	NL4257-93T		NL4257-13T		3mm	15mm
NL4257-74T	NL4257-84T	NL4257-94T				4mm	15mm
NL4257-75T	NL4257-85T	NL4257-95T				5mm	15mm
	NL4257-86T					6mm	15mm

Thin Foot Plate with Ejector

NL4258-72T	◆ NL4258-82T	NL4258-92T		NL4258-22T	2mm	15mm
NL4258-73T	NL4258-83T	NL4258-93T			3mm	15mm
NL4258-74T	◆ NL4258-84T	NL4258-94T		NL4258-24T	4mm	15mm
NL4258-75T		NL4258-95T			5mm	15mm
	NL4258-86T	NL4258-96T			6mm	15mm

Chroma-Line® II KERRISON Rongeurs

Micro handle. 40° up-cutting. Handle has a color-coded insert according to size for easy recognition.



Shaft Length 7in (17.8cm)	Shaft Length 8in (20.3cm)	Shaft Length 9in (22.9cm)	Shaft Length 10in (25.4cm)	Shaft Length 11in (27.9cm)	Shaft Length 12in (30.5cm)	Bite Size	Bite Opening	Color
Without Ejector								
NL4261-71	NL4261-81	NL4261-91		NL4261-11	NL4261-21	1mm	10mm	Red
NL4261-72	NL4261-82	NL4261-92	NL4261-02	NL4261-12	NL4261-22	2mm	10mm	Dark blue
NL4261-73	NL4261-83	NL4261-93	NL4261-03	NL4261-13	NL4261-23	3mm	10mm	Purple
NL4261-74	◆ NL4261-84	NL4261-94	NL4261-04	NL4261-14	NL4261-24	4mm	10mm	Light blue
NL4261-75	◆ NL4261-85	NL4261-95	NL4261-05	NL4261-15	NL4261-25	5mm	10mm	Green
NL4261-76	NL4261-86			NL4261-16		6mm	10mm	Yellow
NL4265-71	○ NL4265-81	NL4265-91				1mm	15mm	Red
NL4265-72	NL4265-82	NL4265-92				2mm	15mm	Dark blue
NL4265-73	NL4265-83	NL4265-93				3mm	15mm	Purple
NL4265-74	NL4265-84	NL4265-94				4mm	15mm	Light blue
NL4265-75	NL4265-85	NL4265-95				5mm	15mm	Green
	NL4265-86					6mm	15mm	Yellow
With Ejector								
NL4263-72	NL4263-82	NL4263-92	NL4263-02	NL4263-12	NL4263-22	2mm	10mm	Dark blue
NL4263-73	NL4263-83	NL4263-93	NL4263-03	NL4263-13	NL4263-23	3mm	10mm	Purple
NL4263-74	NL4263-84	NL4263-94	NL4263-04	NL4263-14	NL4263-24	4mm	10mm	Light blue
NL4263-75	NL4263-85	NL4263-95	NL4263-05	NL4263-15	NL4263-25	5mm	10mm	Green
	NL4263-86					6mm	10mm	Yellow
NL4266-72	NL4266-82	NL4266-92			NL4266-22	2mm	15mm	Dark blue
NL4266-73	NL4266-83				NL4266-23	3mm	15mm	Purple
NL4266-74	NL4266-84				NL4266-24	4mm	15mm	Light blue
NL4266-75	NL4266-85				NL4266-25	5mm	15mm	Green
	NL4266-86				NL4266-26	6mm	15mm	Yellow

Kerrisons/Rongeurs

Kerrisons/Pinces-gouges
 Kerrison-Rongeur/Rongeur
 Kerrison/Pinze ossivore
 Gubias Kerrison/Gubias
 Pinças Kerrison/Saca-bocados
 Kerrisons/骨鉗子

Chroma-Line® Blue KERRISON Rongeurs

Micro handle. 40° up-cutting. Blue-colored, Titanium-Nitride-coated.
 Handle has a color-coded insert according to size for easy recognition.



Shaft Length 7in (17.8cm)	Shaft Length 8in (20.3cm)	Shaft Length 9in (22.9cm)	Shaft Length 10in (25.4cm)	Shaft Length 11in (27.9cm)	Shaft Length 12in (30.5cm)	Bite Size	Bite Opening	Color
Without Ejector								
NL4271-71	NL4271-81	NL4271-91	NL4271-01	NL4271-11	NL4271-21	1mm	10mm	Red
NL4271-72	◆ NL4271-82	NL4271-92	NL4271-02	NL4271-12	NL4271-22	2mm	10mm	Dark blue
NL4271-73	NL4271-83	NL4271-93	NL4271-03	NL4271-13	NL4271-23	3mm	10mm	Purple
NL4271-74	NL4271-84	NL4271-94	NL4271-04	NL4271-14	NL4271-24	4mm	10mm	Light blue
NL4271-75	NL4271-85	NL4271-95	NL4271-05	NL4271-15	NL4271-25	5mm	10mm	Green
NL4271-76	NL4271-86			NL4271-16	NL4271-26	6mm	10mm	Yellow
NL4275-71	NL4275-81	NL4275-91	NL4275-01	NL4275-11	NL4275-21	1mm	15mm	Red
NL4275-72	NL4275-82	NL4275-92	NL4275-02	NL4275-12	NL4275-22	2mm	15mm	Dark blue
NL4275-73	NL4275-83	NL4275-93	NL4275-03	NL4275-13	NL4275-23	3mm	15mm	Purple
NL4275-74	NL4275-84	NL4275-94	NL4275-04	NL4275-14	NL4275-24	4mm	15mm	Light blue
NL4275-75	NL4275-85	NL4275-95	NL4275-05	NL4275-15	NL4275-25	5mm	15mm	Green
	NL4275-86					6mm	15mm	Yellow
With Ejector								
NL4273-72	NL4273-82	NL4273-92	NL4273-02	NL4273-12	NL4273-22	2mm	10mm	Dark blue
NL4273-73	NL4273-83	NL4273-93	NL4273-03	NL4273-13	NL4273-23	3mm	10mm	Purple
NL4273-74	NL4273-84	NL4273-94	NL4273-04	NL4273-14	NL4273-24	4mm	10mm	Light blue
NL4273-75	◆ NL4273-85	NL4273-95	NL4273-05	NL4273-15	NL4273-25	5mm	10mm	Green
NL4273-76	NL4273-86					6mm	10mm	Yellow
NL4276-72						2mm	15mm	Dark blue.
	NL4276-82					2mm	15mm	Light blue
	NL4276-92		NL4276-02	NL4276-12	NL4276-22	2mm	15mm	Dark blue
NL4276-73	NL4276-83	NL4276-93	NL4276-03	NL4276-13	NL4276-23	3mm	15mm	Purple
NL4276-74	NL4276-84	NL4276-94	NL4276-04	NL4276-14	NL4276-24	4mm	15mm	Light blue
NL4276-75	NL4276-85	NL4276-95	NL4276-05	NL4276-15	NL4276-25	5mm	15mm	Green
	NL4276-86					6mm	15mm	Yellow

SPURLING Rongeurs

Titanium Nitride spring.



90° Angle Up-Cutting	40° Angle Up-Cutting	90° Angle Down-Cutting	Bite Size	Shaft Length
NL4070-062	NL4071-062	NL4072-062	2mm	6in (15.2cm)
NL4070-063	NL4071-063	NL4072-063	3mm	6in (15.2cm)
NL4070-064	NL4071-064		4mm	6in (15.2cm)
NL4070-065		NL4072-065	5mm	6in (15.2cm)
	NL4071-066		6mm	6in (15.2cm)
NL4070-072	◆ NL4071-072	NL4072-072	2mm	7in (17.8cm)
NL4070-073	NL4071-073	NL4072-073	3mm	7in (17.8cm)
NL4070-074	NL4071-074	NL4072-074	4mm	7in (17.8cm)
NL4070-075	NL4071-075		5mm	7in (17.8cm)
NL4070-076	NL4071-076		6mm	7in (17.8cm)
NL4070-082	◆ NL4071-082	NL4072-082	2mm	8in (20.3cm)
NL4070-083	◆ NL4071-083	NL4072-083	3mm	8in (20.3cm)
NL4070-084	◆ NL4071-084	NL4072-084	4mm	8in (20.3cm)
NL4070-085	NL4071-085	NL4072-085	5mm	8in (20.3cm)
NL4070-086	NL4071-086	NL4072-086	6mm	8in (20.3cm)
NL4070-112	NL4071-112		2mm	11in (27.9cm)
NL4070-113	NL4071-113		3mm	11in (27.9cm)
NL4070-114	NL4071-114		4mm	11in (27.9cm)
NL4070-115	NL4071-115		5mm	11in (27.9cm)
	NL4071-116		6mm	11in (27.9cm)

Rongeur Forceps

Pince-gouge
Rongeur-Zangen
Pinza ossivora
Fórceps de gubias
Pinça saca-bocado
骨鉗子

Grasping Forceps

Jaws 3mm x 8mm. With tooth.



K-0095

Overall length
5-1/2in (14cm).

K-0096

Overall length
8in (20cm).

SPURLING Rongeur Forceps

Alligator-type. Straight. Cup-shaped jaws 4mm x 10mm.



NL6170

Shaft length
5in (12.7cm).

LOVE-GRUENWALD Forceps

Shaft length 5in (12.7cm).



2mm x 10mm

3mm x 10mm

Part No.

Cup Size

Jaw Angle

◆ **NL6090**

2mm x 10mm wide

Angled up

NL6091

2mm x 10mm

Angled up

◆ **NL6091-001**

2mm x 10mm

Angled down

◆ **NL6092**

3mm x 10mm wide

Straight

LOVE-GRUENWALD Pituitary Rongeur Forceps

Shaft length 7in (17.8cm).

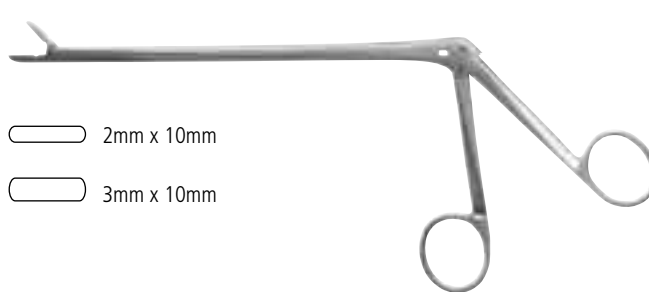

2mm x 10mm

3mm x 10mm

Part No.

Cup Size

Jaw Angle

◆ **NL6146**

2mm x 10mm

Straight

◆ **NL6147**

2mm x 10mm

Angled up

◆ **NL6148**

2mm x 10mm

Angled down

◆ **NL6150**

3mm x 10mm

Straight

◆ **NL6151**

3mm x 10mm

Angled up

◆ **NL6152**

3mm x 10mm

Angled down

OLDBERG Pituitary Rongeur Forceps

Cup-shaped jaws, 5mm diameter.



NL3670

Shaft length 7in (17.8cm).

Micro Cup Forceps

Straight. Overall length 5in (12.5cm).



L-0200

Jaws 1mm wide.

L-0203

Jaws 2mm wide.

Pince-gouge
Rongeur-Zangen
Pinza ossivora
Fórceps de gubias
Pinça saca-bocado
骨鉗子

DECKER Rongeur Forceps

Overall length 6in (15.2cm).



1.5mm x 5mm

Part No.	Cup Size	Jaw Angle	Shaft Length
◆ K-0300	1.5mm x 5mm	Straight	6in (15.2cm)
NL6250-015	1.5mm x 6mm	Straight	6in (15.2cm)
◆ NL6250	2mm x 6mm	Straight	6in (15.2cm)
NL6250-020	2mm x 6mm	Curved Left	5-1/2in (14cm)
NL6250-030	2mm x 6mm	Curved Right	5-1/2in (14cm)
NL6250-002	2mm x 6mm	Curved Up	5-1/2in (14cm)
NL6250-003	2mm x 6mm	Curved Down	5-1/2in (14cm)
NL6255	2mm x 6mm	Straight	7in (17.8cm)
NL6255-002	2mm x 6mm	Curved Up	7in (17.8cm)
NL6255-003	2mm x 6mm	Curved Down	7in (17.8cm)

CLOWARD Spinal Ronguers

Serrated. Jaws 6mm x 10mm.



NL6360-001

Straight.
Overall length
5in (12.7cm).

NL6360-002

Angled up.
Overall length
5in (12.7cm).

NL6360-003

Angled down.
Overall length
5in (12.7cm).

NL6361-001

Straight.
Overall length
6in (15.2cm).

WILDE Rongeur Forceps

Fenestrated cup jaws.



K-0414

Straight.
Jaws 5mm wide.
Overall length
6in (15cm).

K-0421

Straight.
Jaws 3mm wide.
Overall length
7in (18cm).

NL6130

Straight.
Jaws 4mm wide.
Overall length
7in (17.8cm).

K-0422

Straight.
Jaws 4mm wide.
Overall length
7in (18cm).

K-0416

Straight.
Jaws 4mm wide.
Overall length
9in (23cm).

K-0420

Straight.
Jaws 2.5mm wide.
Overall length
7in (18cm).

K-0423

Straight.
Jaws 5mm wide.
Overall length
7in (18cm).

K-0433

Angled.
Jaws 5mm wide.
Overall length
7in (18cm).

FERRIS SMITH Cup Jaw Rongeur Forceps

Shaft length 7in (17.8cm).

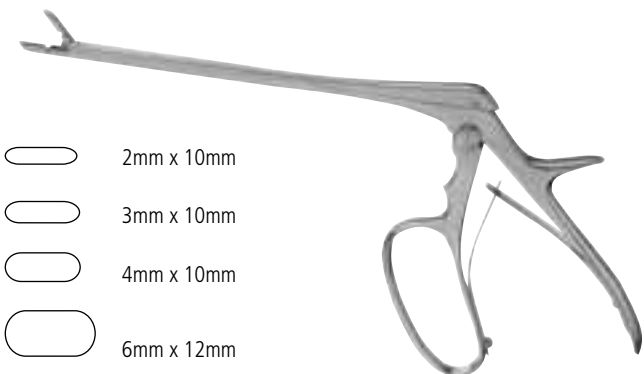

2mm x 10mm

3mm x 10mm

4mm x 10mm

6mm x 12mm

Part No.	Cup Size	Jaw Angle
NL6050	2mm x 10mm	Straight
NL6051	3mm x 10mm	Straight
NL6051-002	3mm x 10mm	Curved Down
NL6052	4mm x 10mm	Straight
NL6052-001	4mm x 10mm	Curved Up
NL6052-002	4mm x 10mm	Curved Down
◆ NL6053	6mm x 12mm	Straight
NL6053-001	6mm x 12mm	Curved Up

Rongeur Forceps

Pince-gouge
Rongeur-Zangen
Pinza ossivora
Fórceps de gubias
Pinça saca-bocado
骨鉗子

SPENCE Rongeur Forceps

Alligator type. Cup-shaped jaws 4mm x 12mm.
Shaft length 7-1/2in (19cm).



NL6200

Straight jaws.

NL6210

Jaws angled down.

NL6212

Jaws angled up.

Intervertebral Disc Rongeurs

Jaws 3mm x 10mm. Shaft length 6in (15.2cm).



NL6230

Straight.

NL6232

Jaws angled up.

NL6234

Jaws angled down.

PEAPOD Rongeurs

Up-cutting jaws.



K-0400

Jaws 1.5mm wide.
Overall length
5-1/2in (14cm).

◆ **NL6240**

Jaws 2mm wide.
Overall length
5-1/2in (14cm).

K-0402

Jaws 2.5mm wide.
Overall length
5-1/2in (14cm).

K-0403

Jaws 3.2mm wide.
Overall length
5-1/2in (14cm).

K-0405

Jaws 2mm wide.
Overall length
7in (18cm).

K-0406

Jaws 2.5mm wide.
Overall length
7in (18cm).

K-0407

Jaws 3.2mm wide.
Overall length
7in (18cm).

Looking for a specific product?

When you know the catalog number or the name of the product you need, you can use the index at the end of this book to direct you to the page on which the product is described. If you do not find the specific instruments you are looking for, please contact your local V. Mueller sales representative or Customer Support at **800.323.9088**.

Pince-gouge
Rongeur-Zangen
Pinza ossivora
Fórceps de gubias
Pinça saca-bocado
骨鉗子

LOVE-GRUENWALD Rongeurs

Jaws 3mm x 10mm. Shaft length 6in (15.2cm).



Part No.	Cup Size	Shaft Length	Jaw Angle
K-0170	3mm x 10mm	7in (18cm)	Straight.
K-0171	3mm x 10mm	7in (18cm)	Up-cutting.
K-0172	3mm x 10mm	7in (18cm)	Down-cutting.
K-0176	3mm x 10mm	7in (18cm)	Straight. With teeth.
K-0177	3mm x 10mm	7in (18cm)	Up-cutting. With teeth.
K-0182	3mm x 10mm	10in (25.5cm)	Straight.
K-0183	3mm x 10mm	10in (25.5cm)	Up-cutting.
K-0184	3mm x 10mm	10in (25.5cm)	Down-cutting.
K-0185	3mm x 10mm	10in (25.5cm)	Straight. With teeth.
K-0188	4mm x 10mm	10in (25.5cm)	Straight.
K-0189	4mm x 10mm	10in (25.5cm)	Up-cutting.
K-0190	4mm x 10mm	10in (25.5cm)	Down-cutting.
K-0191	4mm x 10mm	10in (25.5cm)	Straight. With teeth.
K-0194	5mm x 10mm	10in (25.5cm)	Straight.
K-0195	5mm x 10mm	10in (25.5cm)	Up-cutting.
K-0196	5mm x 10mm	10in (25.5cm)	Down-cutting.
K-0197	5mm x 10mm	10in (25.5cm)	Straight. With teeth.

SELVERSTONE Intervertebral Disc Rongeur Forceps

Straight. Shaft length 6in (15.2cm).



NL6080

Jaws 2mm x 3mm.



NL6081

Jaws 2mm x 5mm.

POPPEL Intervertebral Disc Rongeurs

Cup jaws 4mm x 7mm. Shaft length 6in (15.2cm).



NL6131

Straight.

NL6132

Jaws angled up.

NL6133

Jaws angled down.

Rongeurs

Pinces-gouges
Rongeur
Pinze ossivore
Gubias
Saca-bocados
骨鉗子

HOEN Spinal Rongeur

Jaws 4mm wide. 1 x 2 Teeth.



K-0301

Straight. Overall length
5-1/2in (14cm).

SPURLING Spinal Rongeurs

Jaws 4mm x 10mm.



K-0200

Straight.
Overall length
5in (12.5cm).

NL6160

Straight.
Shaft length
6in (15.2cm).

NL6160-001

Jaws angled up.
Shaft length
6in (15.2cm).

NL6160-002

Jaws angled down.
Shaft length
6in (15.2cm).



◆ **NL6165**

Straight.
Shaft length
7in (17.8cm).

NL6165-001

Jaws angled up.
Shaft length
7in (17.8cm).

NL6165-002

Jaws angled down.
Shaft length
7in (17.8cm).

Intervertebral Disc Rongeurs

Double fenestrated with back of cup serrated. Shaft length 7-1/4in (18.5cm).

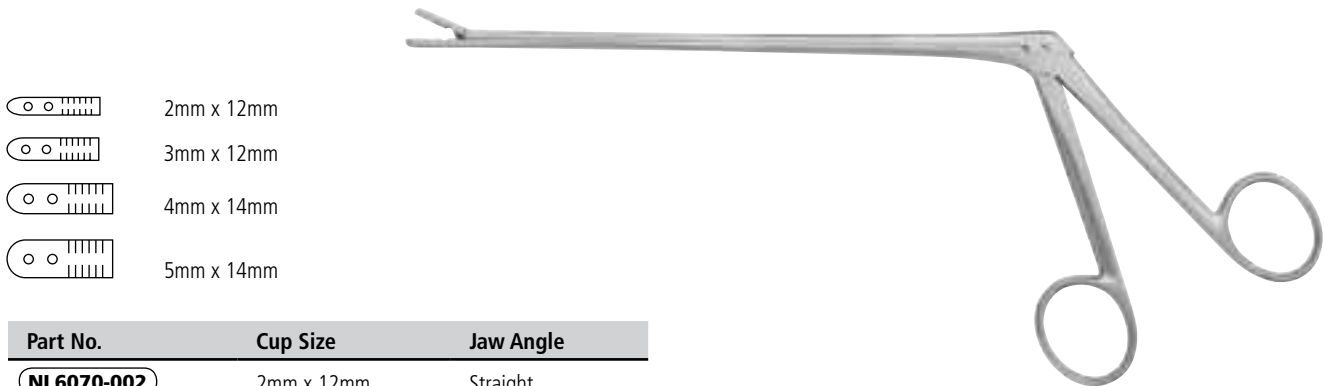

 2mm x 12mm

 3mm x 12mm

 4mm x 14mm

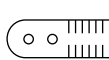
 5mm x 14mm

Part No.	Cup Size	Jaw Angle
NL6070-002	2mm x 12mm	Straight
NL6070-003	3mm x 12mm	Straight
NL6071-003	3mm x 12mm	Curved Up
NL6072-003	3mm x 12mm	Curved Down
NL6070-004	4mm x 14mm	Straight
NL6071-004	4mm x 14mm	Curved Up
NL6072-004	4mm x 14mm	Curved Down
NL6070-005	5mm x 14mm	Straight
NL6071-005	5mm x 14mm	Curved Up

IVD Rongeurs

Overall length 12in (30cm).



Part No.	Cup Size	Jaw Angle
K-0267	2mm x 10mm	Straight
K-0268	2mm x 10mm	Angled up
K-0270	3mm x 10mm	Straight
K-0271	3mm x 10mm	Angled up
K-0272	3mm x 10mm	Angled down
K-0273	4mm x 10mm	Straight
K-0274	4mm x 10mm	Angled up
K-0275	4mm x 10mm	Angled down
K-0276	5mm x 10mm	Straight
K-0277	5mm x 10mm	Angled up

CUSHING Spinal Rongeurs

○ 1.5mm x 10mm

○ 2mm x 10mm



Part No.	Cup Size	Jaw Angle	Shaft Length
◆ NL6225-001	1.5mm x 10mm	Straight	7in (17.8cm)
NL6225-002	1.5mm x 10mm	Angled up	7in (17.8cm)
NL6225-003	1.5mm x 10mm	Angled down	7in (17.8cm)
K-0136	1.5mm x 10mm	Angled up	9in (23cm)
K-0137	1.5mm x 10mm	Angled down	9in (23cm)
○ NL6220-001	2mm x 10mm	Straight	6in (15.2cm)
NL6220-002	2mm x 10mm	Angled up	6in (15.2cm)
NL6220-003	2mm x 10mm	Angled down	6in (15.2cm)
K-0123	2mm x 10mm	Straight	7in (17.8cm)
K-0124	2mm x 10mm	Angled up	7in (17.8cm)
K-0125	2mm x 10mm	Angled down	7in (17.8cm)
K-0133	2mm x 10mm	Straight	7in (17.8cm)
K-0134	2mm x 10mm	Angled up. With teeth	7in (17.8cm)
K-0135	2mm x 10mm	Angled down. With teeth	7in (17.8cm)

Rongeurs

Pinces-gouges
Rongeur
Pinze ossivore
Gubias
Saca-bocados
骨鉗子

Chroma-Line® Spinal Rongeurs

Single-ring handle.



Straight	Up-cutting	Down-cutting	Shaft length	Cup Size	Color
U-0700	U-0701	U-0702	7in (17.8)	1.5mm cup.	Red
U-0710	U-0711	U-0712	7in (17.8)	2mm cup.	Blue
U-0720	U-0721	U-0722	7in (17.8)	3mm cup.	Violet
U-0730	U-0731	U-0732	7in (17.8)	4mm cup.	Turquoise
U-0705	U-0706	U-0707	9in (22.9)	1.5mm cup.	Red
U-0715	U-0716	U-0717	9in (22.9)	2mm cup.	Blue
U-0725	U-0726	U-0727	9in (22.9)	3mm cup.	Violet
U-0735	U-0736	U-0737	9in (22.9)	4mm cup.	Turquoise

Chroma-Line® Spinal Rongeurs

Double-ring handle.



Straight	Up-cutting	Down-cutting	Shaft length	Cup Size	Color
U-0800	U-0801	U-0802	7in (17.8cm)	1.5mm	Red
U-0810	U-0811	U-0812	7in (17.8cm)	2mm	Blue
U-0820	U-0821	U-0822	7in (17.8cm)	3mm	Violet
U-0830	U-0831	U-0832	7in (17.8cm)	4mm	Turquoise
U-0805	U-0806	U-0807	9in (22.9cm)	1.5mm	Red
U-0815	U-0816	U-0817	9in (22.9cm)	2mm	Blue
U-0825	U-0826	U-0827	9in (22.9cm)	3mm	Violet
U-0835	U-0836	U-0837	9in (22.9cm)	4mm	Turquoise

Customer Support

Our highly trained, centralized V. Mueller customer support team is available to take your calls from 7:00 a.m. to 6:00 p.m. (CST), M-F. This group is dedicated to providing a full range of support services, including:

- Order placement
- Order inquiries
- Delivery information
- Product information
- Pricing inquiries

If we can be of assistance, please call us at **800.323.9088**.

ADSON Laminectomy Chisel

Blade 1/2in (1.3cm) wide.
Hollow handle.

NL6550

Overall length 7-1/4in (18.4cm).

**ROCHESTER Elevator and Dissector**

1/8in (3mm) wide.

NL6500

Overall length 9in (22.9cm).

**DAWSON-YUHL Key Type Elevators**

Overall length
11in (27.9cm).

NL7100-034

Blade 3/4in (1.9cm) wide.

NL7100-035

Blade 1in (2.5cm) wide.



Curettes

Curettes
Küretten
Curette
Curetas
Curetas
キュレット

RANEY Stirrup-Loop Curettes

Cuts on both sides.



NL6730

Style 1, slightly curved.
Overall length
9-1/2in (24.1cm).

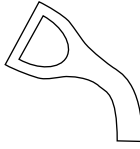

NL6732

Style 3, substantially curved.
Overall length
9-1/4in (23.5cm).

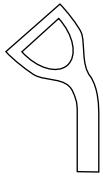

NL6731

Style 2, moderately curved.
Overall length
9-1/4in (23.5cm).



SCOVILLE Ruptured Disc Curettes

4mm x 10mm cup.
Overall length
10in (25.4cm).



NL6765

Straight.

NL6766

Angled 45°.

NL6767

Angled down.

NL6768

Horizontal.



Cone Ring Curettes

Aluminum handle. Overall length 9in (22.9cm).

NL6735

Straight. 4mm diameter.

NL6736

Straight. 7mm diameter.

NL6737

Straight. 9.5mm diameter.

NL6738

Angled. 4mm diameter.

NL6739

Angled. 7mm diameter.

NL6740

Angled. 9.5mm diameter.



DAWSON-YUHL Cone Curettes

Overall length 11in (27.9cm).

NL7100-028

Straight. 4mm diameter.

NL7100-029

Straight. 7mm diameter.

NL7100-030

Angled. 4mm diameter.

NL7100-031

Angled. 7mm diameter.



Chroma-Line® Micro Spinal Curettes

Straight. Round handle design enhances range of motion. Overall length 9-1/4in (23.5cm).

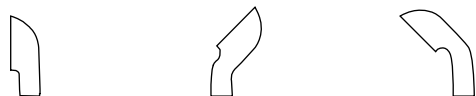

U-2190

U-2252



Straight	Angled	Reverse Angled	Cup Size	Color
U-2175	U-2190	U-2205	000000	Red
U-2176	U-2191	U-2206	00000	Silver
U-2177	U-2192	U-2207	0000	Violet
U-2178	U-2193	U-2208	000	Turquoise
U-2179	U-2194	U-2209	00	Gold
U-2180	U-2195	U-2210	0	Green
U-2181	U-2196	U-2211	1	Orange
U-2182	U-2197	U-2212	2	Blue

Straight Up	Straight Down	Angled Up	Angled Down	Reverse Angled Up	Reverse Angled Down	Cup Size	Color
U-2220	U-2235	U-2250			U-2295	000000	Red
U-2221	U-2236	U-2251	U-2266	U-2281	U-2296	00000	Silver
U-2222	U-2237	U-2252	U-2267	U-2282	U-2297	0000	Violet
U-2223	U-2238	U-2253	U-2268	U-2283	U-2298	000	Turquoise
U-2224	U-2239	U-2254	U-2269	U-2284	U-2299	00	Gold
U-2225	U-2240	U-2255	U-2270	U-2285	U-2300	0	Green
U-2226	U-2241	U-2256		U-2286	U-2301	1	Orange
U-2227		U-2257		U-2287	U-2302	2	Blue

Chroma-Line® Upper Spinal Curettes

Overall length 10in (25.4cm).

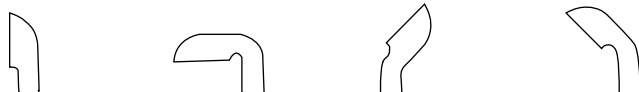

Straight	Angled 90°	Reverse Angled	Angled	Cup Size	Color
U-0174	U-0186	U-0162	U-0150	000000	Red
U-0175	U-0187	U-0163	U-0151	00000	Silver
◆ U-0176	U-0188	◆ U-0164	U-0152	0000	Violet
U-0177	U-0189	◆ U-0165	U-0153	000	Turquoise
◆ U-0178	U-0190	◆ U-0166	U-0154	00	Gold
U-0179	U-0191	◆ U-0167	U-0155	0	Green
U-0180	U-0192	U-0168	U-0156	1	Orange
U-0181	U-0193	U-0169	U-0157	2	Blue
U-0182	U-0194	U-0170	U-0158	3	Gray
U-0183	U-0195	U-0171	U-0159	4	Black
U-0184	U-0196	U-0172	U-0160	5	Black
U-0185	U-0197	U-0173	U-0161	6	Black



NEURO/SPINE
AND ORTHOPEDIC

Curettes

Curettes
Küretten
Curette
Curetas
Curetas
キュレット

Chroma-Line® Lower Spine Curettes

Overall length 13-3/4in (34.9cm).



Straight	Angled	Reverse Angled	Cup Size	Color
U-0224	U-0212	U-0200	000000	Red
U-0225	U-0213	U-0201	00000	Silver
U-0226	U-0214	U-0202	0000	Violet
U-0227	U-0215	U-0203	000	Turquoise
U-0228	U-0216	U-0204	00	Gold
U-0229	U-0217	U-0205	0	Green
U-0230	U-0218	U-0206	1	Orange
U-0231	U-0219	U-0207	2	Blue
U-0232	U-0220	U-0208	3	Gray
U-0233	U-0221	U-0209	4	Black
U-0234	U-0222	U-0210	5	Black
U-0235	U-0223	U-0211	6	Black



Curette Sterilization and Storage Racks

Holds 12.

Y-0101

For 9in and 10in (25.4cm) curettes.

Y-0102

For 13-3/4in (34.9cm) curettes.



Ensemble d'écarteurs Shadow-Line®
 Shadow-Line® Wundspreizer-Set
 Set divaricatore Shadow-Line®
 Juego de separadores Shadow-Line®
 Conjunto de retratores Shadow-Line®
 Shadow-Line®リトラクターセット

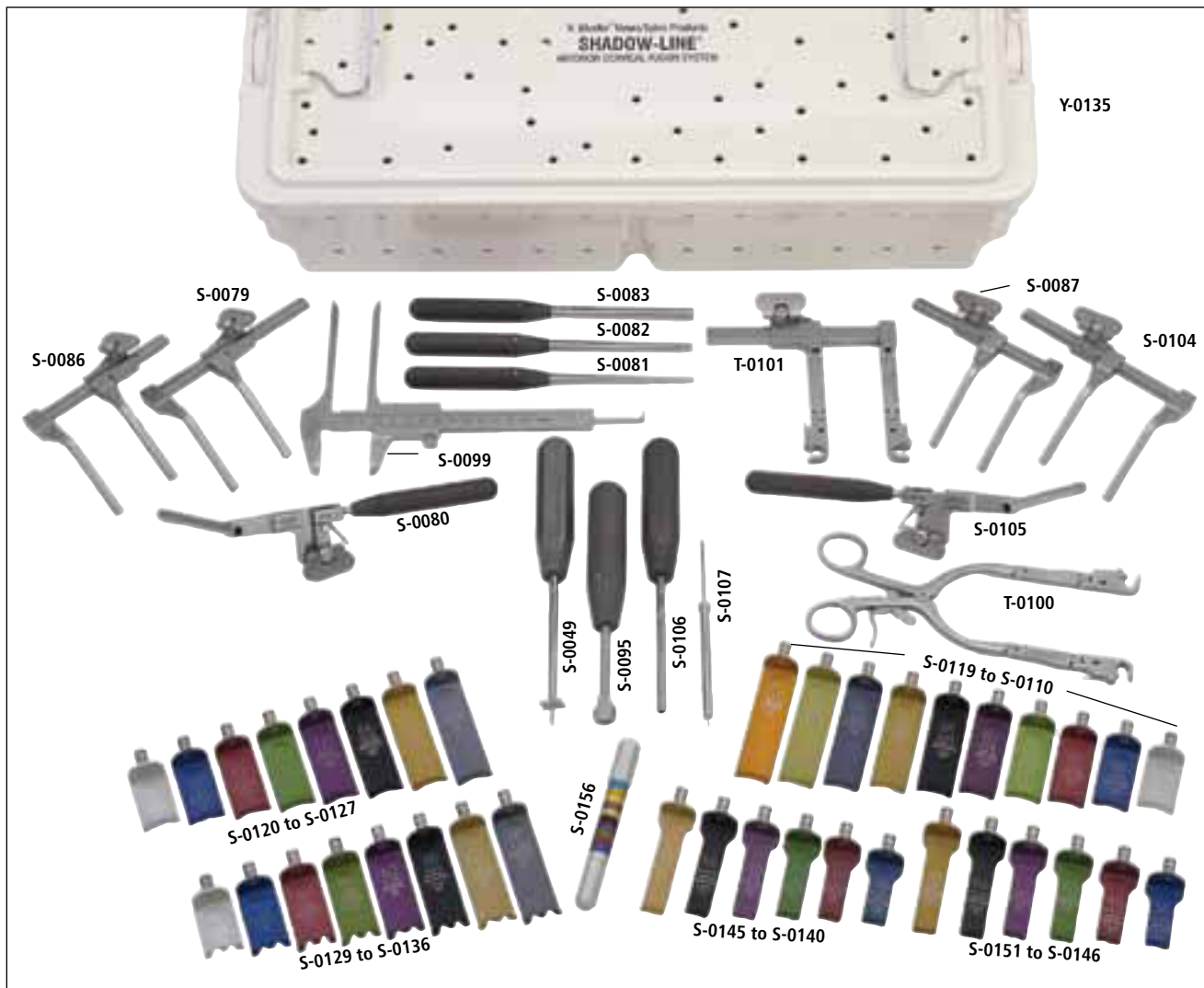

NEURO/SPINE
 AND ORTHOPEDIC

SHADOW-LINE® Spinal Retractor and Distraction Set

The Shadow-Line® Spinal Retractor System provides operative versatility by combining unilateral and bilateral retraction in a single system.

- Patented side-loading blade attachment design facilitates blade engagement and ensures muscle and tissue retraction.
- Radiolucent aluminum retractor blades allow for intra-operative X-ray and fluoroscopic visualization.
- Shadow-Line® color-coding system with color-coded depth gauge simplifies blade selection, optimizing efficiency.
- Blade attachment design allows for full interchangeability with the Versa-Trac® retractor system components, expanding retraction possibilities and indications.
- Blade length and width configurations, as well as low-profile, double-hinged retractor frame design, easily adapt to a wide range of procedures.
- Set components can be ordered individually.

Shadow-Line® Retractor Set

Ensemble d'écarteurs Shadow-Line®
 Shadow-Line® Wundspreizer-Set
 Set divaricatore Shadow-Line®
 Juego de separadores Shadow-Line®
 Conjunto de retratores Shadow-Line®
 Shadow-Line®リトラクターセット

SHADOW-LINE® Spinal Retractor and Set

◆ **Z-0102**

Set includes the following:

Cat. No.	Description	Set Quantity
S-0156	Depth gauge. Color-coded.	1 ea
T-1295	Locking retractor handle. Side-loading.	2 ea
T-0104	Step-down transverse retractor frame. Double-hinged. Side-loading.	1 ea
T-0101	Transverse retractor frame. Double-hinged. Side-loading. Opening 120mm.	1 ea
Y-0125	Instrument case.	1 ea
S-0110	Tissue blade. Blunt. Blade 30mm x 23mm wide. Silver.	2 ea
S-0111	Tissue blade. Blunt. Blade 35mm x 23mm wide. Blue.	2 ea
S-0112	Tissue blade. Blunt. Blade 40mm x 23mm wide. Red.	2 ea
S-0113	Tissue blade. Blunt. Blade 45mm x 23mm wide. Green.	2 ea
S-0114	Tissue blade. Blunt. Blade 50mm x 23mm wide. Violet.	2 ea
S-0115	Tissue blade. Blunt. Blade 55mm x 23mm wide. Black.	2 ea
S-0116	Tissue blade. Blunt. Blade 60mm x 23mm wide. Gold.	2 ea
S-0117	Tissue blade. Blunt. Blade 65mm x 23mm wide. Navy.	2 ea
S-0118	Tissue blade. Blunt. Blade 70mm x 23mm wide. Light green.	2 ea
S-0119	Tissue blade. Blunt. Blade 75mm x 75mm wide. Orange.	2 ea
S-0146	Narrow muscle blade. Short teeth. Blade 35mm x 14mm wide. Blue.	2 ea
S-0147	Narrow muscle blade. Short teeth. Blade 40mm x 14mm wide. Red.	2 ea
S-0148	Narrow muscle blade. Short teeth. Blade 45mm x 14mm wide. Green.	2 ea
S-0149	Narrow muscle blade. Short teeth. Blade 50mm x 14mm wide. Violet.	2 ea
S-0150	Narrow muscle blade. Short teeth. Blade 55mm x 14mm wide. Black.	2 ea
S-0151	Narrow muscle blade. Short teeth. Blade 60mm x 14mm wide. Gold.	2 ea
S-0120	Lateral muscle blade. Short teeth. Blade 30mm x 23mm wide. Silver.	1 ea
S-0121	Lateral muscle blade. Short teeth. Blade 35mm x 23mm wide. Blue.	1 ea
S-0122	Lateral muscle blade. Short teeth. Blade 40mm x 23mm wide. Red.	1 ea
S-0123	Lateral muscle blade. Short teeth. Blade 45mm x 23mm wide. Green.	1 ea
S-0124	Lateral muscle blade. Short teeth. Blade 50mm x 23mm wide. Violet.	1 ea
S-0125	Lateral muscle blade. Short teeth. Blade 55mm x 23mm wide. Black.	1 ea
S-0126	Lateral muscle blade. Short teeth. Blade 60mm x 23mm wide. Gold.	1 ea
S-0127	Lateral muscle blade. Short teeth. Blade 65mm x 23mm wide. Navy.	1 ea
S-0129	Median muscle blade. Long teeth. Blade 30mm x 23mm wide. Silver.	1 ea
S-0130	Median muscle blade. Long teeth. Blade 35mm x 23mm wide. Blue.	1 ea
S-0131	Median muscle blade. Long teeth. Blade 40mm x 23mm wide. Red.	1 ea
S-0132	Median muscle blade. Long teeth. Blade 45mm x 23mm wide. Green.	1 ea
S-0133	Median muscle blade. Long teeth. Blade 50mm x 23mm wide. Violet.	1 ea
S-0134	Median muscle blade. Long teeth. Blade 55mm x 23mm wide. Black.	1 ea
S-0135	Median muscle blade. Long teeth. Blade 60mm x 23mm wide. Gold.	1 ea
S-0136	Median muscle blade. Long teeth. Blade 65mm x 23mm wide. Navy.	1 ea
S-0140	Narrow tissue blade. Blunt. Blade 35mm x 14mm wide. Blue.	2 ea
S-0141	Narrow tissue blade. Blunt. Blade 40mm x 14mm wide. Red.	2 ea
S-0142	Narrow tissue blade. Blunt. Blade 45mm x 14mm wide. Green.	2 ea
S-0143	Narrow tissue blade. Blunt. Blade 50mm x 14mm wide. Violet.	2 ea
S-0144	Narrow tissue blade. Blunt. Blade 55mm x 14mm wide. Black.	2 ea
S-0145	Narrow tissue blade. Blunt. Blade 60mm x 14mm wide. Gold.	2 ea

Shadow-Line Spine Distraction System

Cat. No.	Description	Qty.	Z-0102DG Set in a Genesis™ Container	Z-0102DC Set in a Sterilization Case
Z-0102DGP	Distraction platform for Genesis container	1	X	
Z-0102DDP	Distraction platform, DIN size	1		X
Z-CASE	Sterilization case	1		X
CD3-5B	U.S.-sized Genesis container	1	X	
S-0086	Shadow-Line spinal distractor, left, 100 mm rack	1	X	X
S-0087	Shadow-Line spinal distractor, right, 100 mm rack	1	X	X
S-0079	Shadow-Line spinal distractor, left, 120 mm rack	1	X	X
S-0104	Shadow-Line spinal distractor, right, 120 mm rack	1	X	X
S-1280	Shadow-Line spinal distraction drill guide, left, aluminum handle	1	X	X
S-1505	Shadow-Line spinal distraction drill guide, right, aluminum handle	1	X	X
S-1306	Shadow-Line spinal distraction screwdriver, aluminum handle	1	X	X
S-0107	Shadow-Line spinal distraction twist drill	1	X	X

SHADOW-LINE® Color-Coded Depth Gauge

S-0156 Aluminum. For indications up to 100mm.

SHADOW-LINE® Locking Retractor Handle

T-1295 Side-loading.

SHADOW-LINE® Longitudinal Retractor Frame

T-0100 Double-hinged.

SHADOW-LINE® Transverse Retractors

T-0101 Side-loading. Double-hinged. Opening 120mm

SHADOW-LINE® Tissue Blades

Aluminum. Blunt. Blades 23mm wide.

Cat. No.	Description	Color
S-0110	Blade length 30mm	Silver
S-0111	Blade length 35mm	Blue
S-0112	Blade length 40mm	Red
S-0113	Blade length 45mm	Green
S-0114	Blade length 50mm	Violet
S-0115	Blade length 55mm	Black
S-0116	Blade length 60mm	Gold
S-0117	Blade length 65mm	Navy
S-0118	Blade length 70mm	Light green
S-0119	Blade length 75mm	Orange

SHADOW-LINE® Narrow Muscle Blades

Aluminum. Short teeth. Blades 14mm wide.

Cat. No.	Description	Color
S-0146	Blade length 35mm	Blue
S-0147	Blade length 40mm	Red
S-0148	Blade length 45mm	Green
S-0149	Blade length 50mm	Violet
S-0150	Blade length 55mm	Black
S-0151	Blade length 60mm	Gold

SHADOW-LINE® Lateral Muscle Blades

Aluminum. Short teeth. Blades 23mm wide.

Cat. No.	Description	Color
S-0120	Blade length 30mm	Silver
S-0121	Blade length 35mm	Blue
S-0122	Blade length 40mm	Red
S-0123	Blade length 45mm	Green
S-0124	Blade length 50mm	Violet
S-0125	Blade length 55mm	Black
S-0126	Blade length 60mm	Gold
S-0127	Blade length 65mm	Navy
S-0128	Blade length 70mm.	Light green

SHADOW-LINE® Medial Muscle Blades

Aluminum. Long teeth. Blades 23mm wide.

Cat. No.	Description	Color
S-0129	Blade length 30mm	Silver
S-0130	Blade length 35mm	Blue
S-0131	Blade length 40mm	Red
S-0132	Blade length 45mm	Green
S-0133	Blade length 50mm	Violet
S-0134	Blade length 55mm	Black
S-0135	Blade length 60mm	Gold
S-0136	Blade length 65mm	Navy
S-0137	Blade length 70mm.	Light green

SHADOW-LINE® Narrow Tissue Blades

Aluminum. Blunt. Blades 14mm wide.

Cat. No.	Description	Color
S-0140	Blade length 35mm	Blue
S-0141	Blade length 40mm	Red
S-0142	Blade length 45mm	Green
S-0143	Blade length 50mm	Violet
S-0144	Blade length 55mm	Black
S-0145	Blade length 60mm	Gold

SHADOW-LINE® SCOVILLE Retractor Blade

S-0430 Blade 40mm x 38 wide

SHADOW-LINE® TAYLOR Retractor Blades

S-0432 Blade 44mm x 38mm wide
S-0433 Blade 51mm x 40mm wide
S-0434 Blade 63mm x 57mm wide

Shadow-Line® Instruments

Instruments Shadow-Line®
 Shadow-Line® Instrumente
 Strumenti Shadow-Line®
 Instrumentos Shadow-Line®
 Instrumentos Shadow-Line®
 Shadow-Line® 器具

SHADOW-LINE® Side Loading Retractor Handle

T-1295

Blade length 60mm.



SHADOW-LINE® Transverse Retractors

Side-loading. Double-hinged.

T-0101

Opening 120mm.

T-0103

Multi-level. Opening 150mm.

T-0108

Multi-level. Opening 200mm.



SHADOW-LINE® Step-Down Transverse Retractor

Side-loading. Double-hinged.

T-0104

Opening 120mm.



SHADOW-LINE® Longitudinal Retractor

Top-loading. Double-hinged.

S-0100



SHADOW-LINE® Transverse Retractors

Top-Loading. Double-hinged.

S-0101

Opening 120mm.

S-0103

Opening 150mm.

S-0108

Opening 200mm.



SHADOW-LINE® Distractors

S-0087

Right. Opening 100mm.

S-0104

Right. Opening 120mm.

S-0109

Right. Opening 150mm.

S-0086

Left. Opening 100mm.

S-0079

Left. Opening 120mm.

S-0078

Left. Opening 150mm.



SHADOW-LINE® Bone Graft Holder

Overall length
 8-1/2in (21.6cm).

◆ **S-0049**



SHADOW-LINE® Left Drill Guide

For Distractors S-0078, S-0079, S-0086.

S-1280



SHADOW-LINE® Right Drill Guide

For Distractors S-0087, S-0104, S-0109.

S-1505



Shadow-Line® Instruments/Distraktion Screws

Instruments Shadow-Line®/Vis de distraction
 Shadow-Line® Instrumente/Distraktionsschrauben
 Strumenti Shadow-Line®/Viti di distrazione
 Instrumentos Shadow-Line®/Tornillos de distracción
 Instrumentos Shadow-Line®/Parafusos de distração
 Shadow-Line® 器具/ディストラクションねじ

SHADOW-LINE® Caliper

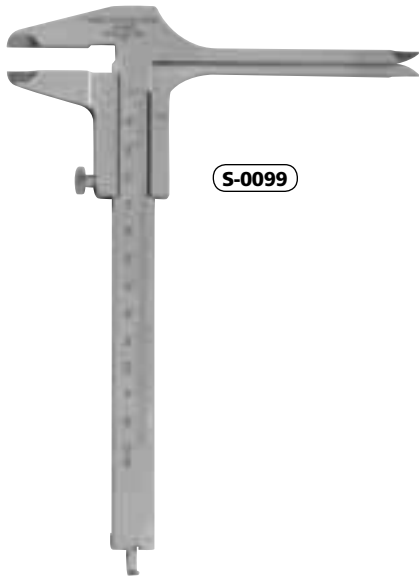

S-0099

SHADOW-LINE® Distraction Screwdriver

S-1306



SHADOW-LINE® Twist Drill

Cutting bit diameter 1.7mm.

S-0107



SHADOW-LINE® Bone Removal Forceps

◆ **S-0084**

Tip 7mm.

S-0085

Tip 10mm.



Distraction Screws

Packaged sterile. 5 per box.

S-0088

12mm. Sterile.

S-0089

14mm. Sterile.

◆ **S-0090**

16mm. Sterile.

S-0091

18mm. Sterile.

Distraction Screws

Packaged non-sterile individually.

S-0096

12mm. Non-sterile.

S-0097

14mm. Non-sterile.

S-0098

16mm. Non-sterile.

S-0092

18mm. Non-sterile.



-2,3

Ballonnets gonflables de cimentation osseuse/Boîtiers
 Knochenstößel/Behälter
 Dispositivi di compressione ossea/Custodie
 Impactores óseos/Estuches
 Calcadores ósseos/Caixas
 ボーンタンプ/ケース

SHADOW-LINE® Bone Tamps

S-0081

3mm diameter.



S-0082

5mm diameter.



S-0083

8mm diameter.



V. Mueller Instrument Detergents

To assist with the care and handling of your instruments, CareFusion offers you a full line of cleaning and decontamination products detailed in the Genesis Sterilization Containers and Instrument Processing Supplies section of this armamentarium.

SHADOW-LINE® Spinal Retractor System Cases

Holds retractor and distraction bodies.

Y-0125

For SHADOW-LINE® set Z-0102. Includes lid, upper insert, middle insert and base.

Y-0135-0

Lid.

Y-0135-1

Upper insert.

Y-0135-2

Middle insert.

Y-0135-5

Base.



Cases

Boîtiers
Behälter
Custodie
Estuches
Caixas
ケース



Z-0102RC



Z-0102DG

SHADOW-LINE® Retraction/Distraktion Platforms and Sets

Part No.	Description
Z-0102ARD	Step-down Platform. DIN Size.
Z-0102ARG	Step-down Platform with GENESIS™ container CD3-5B.
Z-0102DC	Distraction set. DIN Sized Z-Case.
Z-0102DD	Distraction set with GENESIS™ container CD3-5B.
Z-0102DDP	Distraction Platform. Single level. DIN Size.
Z-0102DG	DISTRACTION SET WITH GENESIS™ CONTAINER CD3-5B.
Z-0102DGP	Distraction Platform. Single level. For CD3-5B.
Z-0102RC	RETRACTION SET. DIN SIZED Z-CASE.
Z-0102RD	Retraction Platform. DIN Size Z-Case.
Z-0102RDP	Retraction Platform. Two levels. DIN Size Z-Case.
Z-0102RG	Retraction set with GENESIS™ container CD3-5B.
Z-0102RGP	Retraction Platform. Two levels. For CD3-5B.
Z-CASE	Perforated Sterilization case. DIN Size.

SHADOW-LINE® Perforated Sterilization Case



Z-CASE

DIN Size

Versa-Trac® Retractor Set

Ensemble d'écarteurs Versa-Trac®
 Versa-Trac® Wundspreizer-Set
 Set divaricatore Versa-Trac®
 Juego de separadores Versa-Trac®
 Conjunto de retractoros Versa-Trac®
 Versa-Trac® リトラクターセット

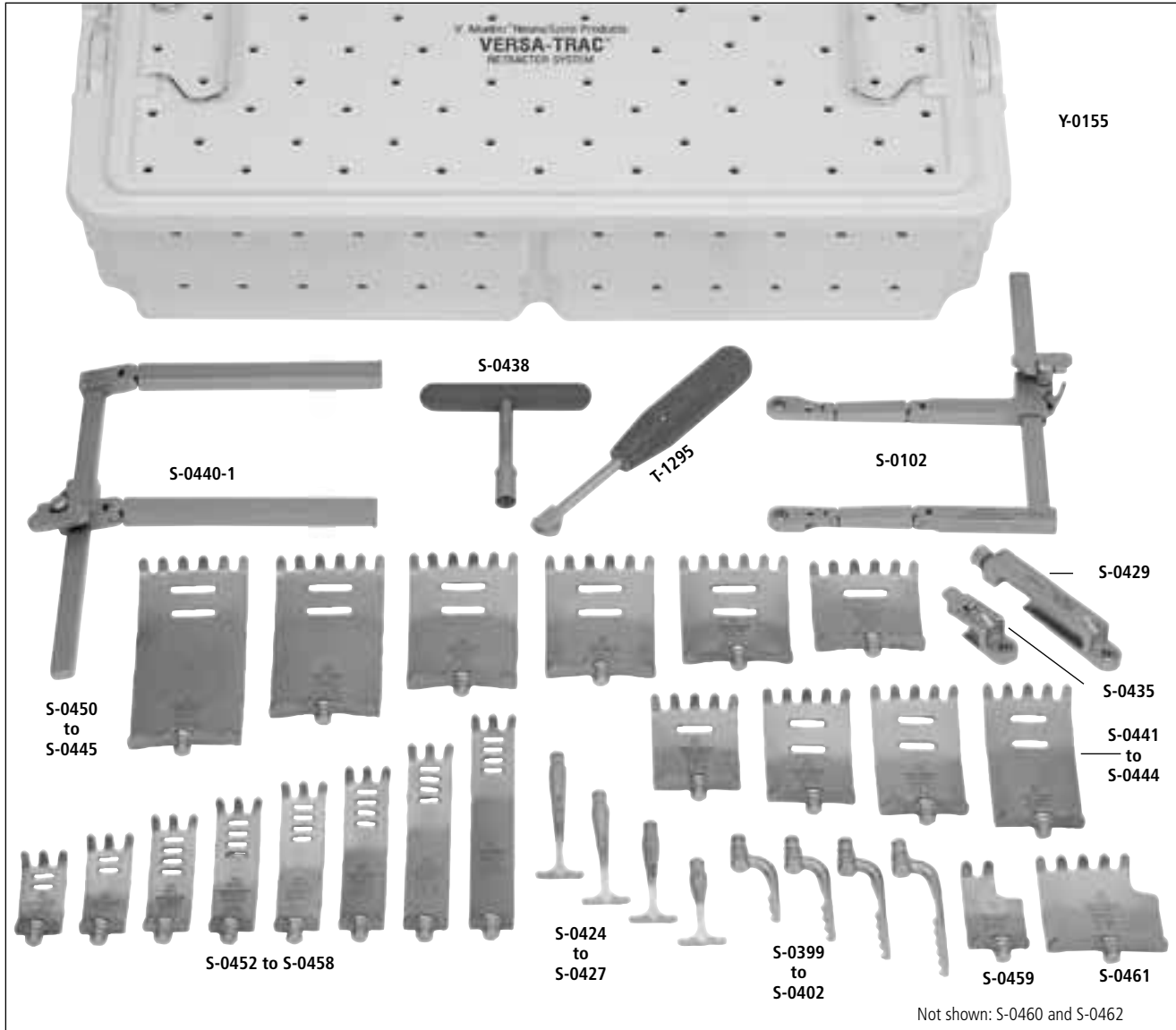

NEURO/SPINE
 AND ORTHOPEDIC

The Versa-Trac® Lumbar Retractor System provides operative versatility – combining unilateral, bilateral, micro and macro lumbar spine retraction in a single system. Translucent titanium blades allow for intra-operative X-ray or fluoroscopic visualization. Blade attachment design allows full interchangeability with the Shadow-Line® Spine Retractor System components, expanding retraction possibilities and indications.

The Versa-Trac® Lumbar Retractor System is available in a Master Set (catalog number Z-0150) and a Basic Set (catalog number Z-0151). Both sets are offered with the standard 15° blade design. The Master Set includes common items used to perform spine procedures from T1 through S1.

Versa-Trac® Retractor Set

Ensemble d'écarteurs Versa-Trac®
Versa-Trac® Wundspreizer-Set
Set divaricatore Versa-Trac®
Juego de separadores Versa-Trac®
Conjunto de retratores Versa-Trac®
Versa-Trac® リトラクターセット

VERSA-TRAC® Lumbar Retractor Master Set

Set includes the following:

Z-0150

Cat. No.	Description	Set Quantity
----------	-------------	--------------

VERSA-TRAC® SCOVILLE Retractor Frame

Double-hinged.

S-0102 Opening 200mm.

VERSA-TRAC® Hooks

Sharp. Multiple teeth.

S-0399 Length 40mm.

S-0400 Length 50mm.

S-0401 Length 60mm.

S-0402 Length 70mm.

VERSA-TRA1C® Lumbar Spine T-Bars

25mm wide.

S-0424 Length 40mm.

S-0425 Length 50mm.

S-0426 Length 60mm.

S-0427 Length 70mm.

VERSA-TRAC® Titanium Muscle Blades

Angled 15°. With teeth. Blade 45mm wide.

S-0441 Blade length 50mm.

S-0442 Blade length 60mm.

S-0443 Blade length 70mm.

S-0444 Blade length 80mm.

titanium

VERSA-TRAC® Titanium Wide Muscle Blades

Angled 15°. With teeth.

S-0445 Blade 60 x 50mm wide.

S-0446 Blade 60mm x 60mm wide.

S-0447 Blade 70mm x 60mm wide.

S-0448 Blade 80mm x 60mm wide.

S-0449 Blade 100mm x 60mm wide.

S-0450 Blade 120mm x 60mm wide.

titanium

VERSA-TRAC® Titanium Wide Sacral Blades

Angled 15°. With teeth.

S-0459 Blade 45mm x 60mm wide. Left.

S-0462 Blade 40mm x 30mm wide. Left.

S-0460 Blade 40mm x 30mm wide. Right.

S-0461 Blade 45mm x 60mm wide. Right.

titanium

VERSA-TRAC® Lumbar Retractor Basic Set

Set includes the following:

Z-0151

Cat. No.	Description	Set Quantity
----------	-------------	--------------

S-0435 Lumbar retractor blade holder. Side-loading. 6 each

S-0429 Adjustable lumbar retractor blade holder. Side-loading. 4 each

S-0438 Lumbar retractor T-handle. 1 each

S-0440-1 Lumbar retractor frame. Holds multiple blades. Opening 225mm. 1 each

T-1295 Locking retractor handle. Side-loading. 2 each

Y-0155 Instrument case. 1 each

S-0452 Titanium narrow muscle blade. Angled 15°. With teeth. Blade 35mm x 23mm wide. 4 each

S-0453 Titanium narrow muscle blade. Angled 15°. With teeth. Blade 45mm x 23mm wide. 4 each

S-0454 Titanium narrow muscle blade. Angled 15°. With teeth. Blade 55mm x 23mm wide. 4 each

S-0451 Titanium narrow muscle blade. Angled 15°. With teeth. Blade 65mm x 23mm wide. 4 each

S-0455 Titanium narrow muscle blade. Angled 15°. With teeth. Blade 75mm x 23mm wide. 4 each

S-0456 Titanium narrow muscle blade. Angled 15°. With teeth. Blade 85mm x 23mm wide. 4 each

S-0457 Titanium narrow muscle blade. Angled 15°. With teeth. Blade 100mm x 23mm wide. 4 each

S-0458 Titanium narrow muscle blade. Angled 15°. With teeth. Blade 120mm x 23mm wide. 4 each

titanium

VERSA-TRAC® Titanium Narrow Muscle Blades

Angled 15°. With teeth. Blade 23 mm wide.

S-0452 Blade length 35mm.

S-0453 Blade length 45mm.

S-0454 Blade length 55mm.

S-0451 Blade length 65mm.

S-0455 Blade length 75mm.

S-0456 Blade length 85mm.

S-0457 Blade length 100mm.

S-0458 Blade length 120mm.

VERSA-TRAC® Titanium Muscle Blades

Angled 30°. With teeth. Blade 45mm wide.

Cat. No.	Description
S-1441	Blade length 50mm.
S-1442	Blade length 60mm.
S-1443	Blade length 70mm.
S-1444	Blade length 80mm.

titanium**VERSA-TRAC® Titanium Wide Muscle Blades**

Angled 30°. With teeth.

S-1445	Blade 50mm x 60mm wide.
S-1446	Blade 60mm x 60mm wide.
S-1447	Blade 60mm x 70mm wide.
S-1448	Blade 60mm x 80mm wide.
S-1449	Blade 60mm x 100mm wide.
S-1450	Blade 60mm x 120mm wide.

titanium**VERSA-TRAC® Titanium Narrow Muscle Blades**

Angled 30°. With teeth. Blades 23mm wide.

S-1452	Blade length 35mm.
S-1453	Blade length 45mm.
S-1454	Blade length 55mm.
S-1451	Blade length 65mm.
S-1455	Blade length 75mm.
S-1456	Blade length 85mm.
S-1457	Blade length 100mm.
S-1458	Blade length 120mm.

titanium**VERSA-TRAC® Hooks**

Sharp.

S-0405	Length 40mm.
S-0406	Length 50mm.
S-0407	Length 60mm.
S-0408	Length 70mm.
S-0410	Length 80mm.
S-0411	Length 90mm.
S-0412	Length 100mm.
S-0414	Length 120mm.

**VERSA-TRAC® Hooks**

Offset. Sharp.

S-0470	Length 30mm.
S-0471	Length 40mm.
S-0472	Length 50mm.
S-0473	Length 60mm.
S-0474	Length 75mm.
S-0475	Length 85mm.
S-0476	Length 95mm.
S-0478	Length 115mm.

**VERSA-TRAC® Multiple-Toothed Hooks****S-0397**

Length 25mm.

S-0398

Length 30mm.

S-0399

Length 40mm.

S-0400

Length 50mm.

S-0401

Length 60mm.

S-0402

Length 70mm.

S-0403

Length 80mm.



Retractors/Cases

Écarteurs/Boîtiers
Wundspreizer/Rektoren/Behälter
Divaricatori/Custodie
Separadores/Estuches
Retradores/Caixas
リトラクター/ケース

VERSA-TRAC® Lumbar Retractor Frame

Holds multiple blades.

S-0440-1

Opening 225mm.

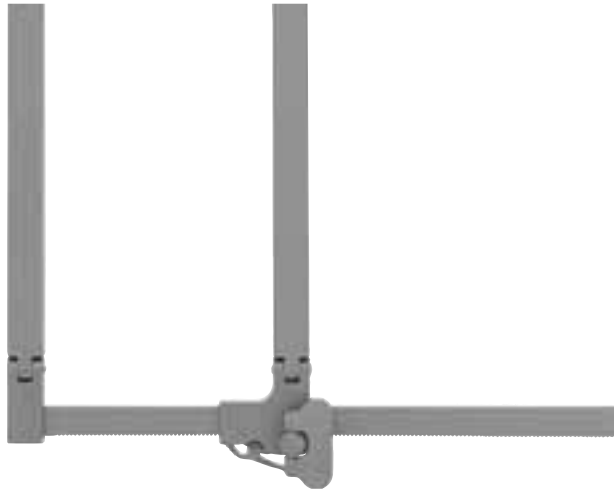

To learn how the IMPRESS system can help improve process performance, reduce immediate-use steam sterilization, decrease case delays, and improve patient care by monitoring instrument flow within your facility, contact your V. Mueller sales representative.

VERSA-TRAC® Retractor Cases

For Lumbar Retractor Set Z-0150.

Y-0155-0

Lid.

Y-0155-1

Upper insert.

Y-0155-2

Middle insert.

Y-0155-3

Lower insert.

Y-0155-4

Base.

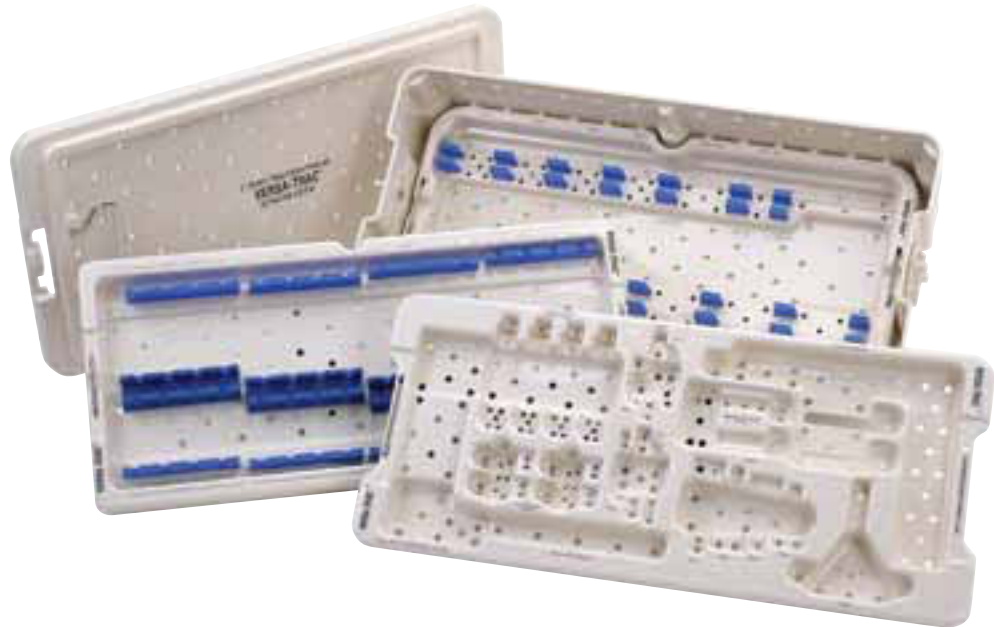

Shadow-Line® McCulloch Retractor Set

Ensemble d'écarteurs McCulloch Shadow-Line®
 Shadow-Line® McCulloch-Wundspreizer-Set
 Set divaricatore Shadow-Line® McCulloch
 Juego de separadores McCulloch Shadow-Line®
 Conjunto de retractoros Shadow-Line® McCulloch
 Shadow-Line® McCulloch リトラクターセット

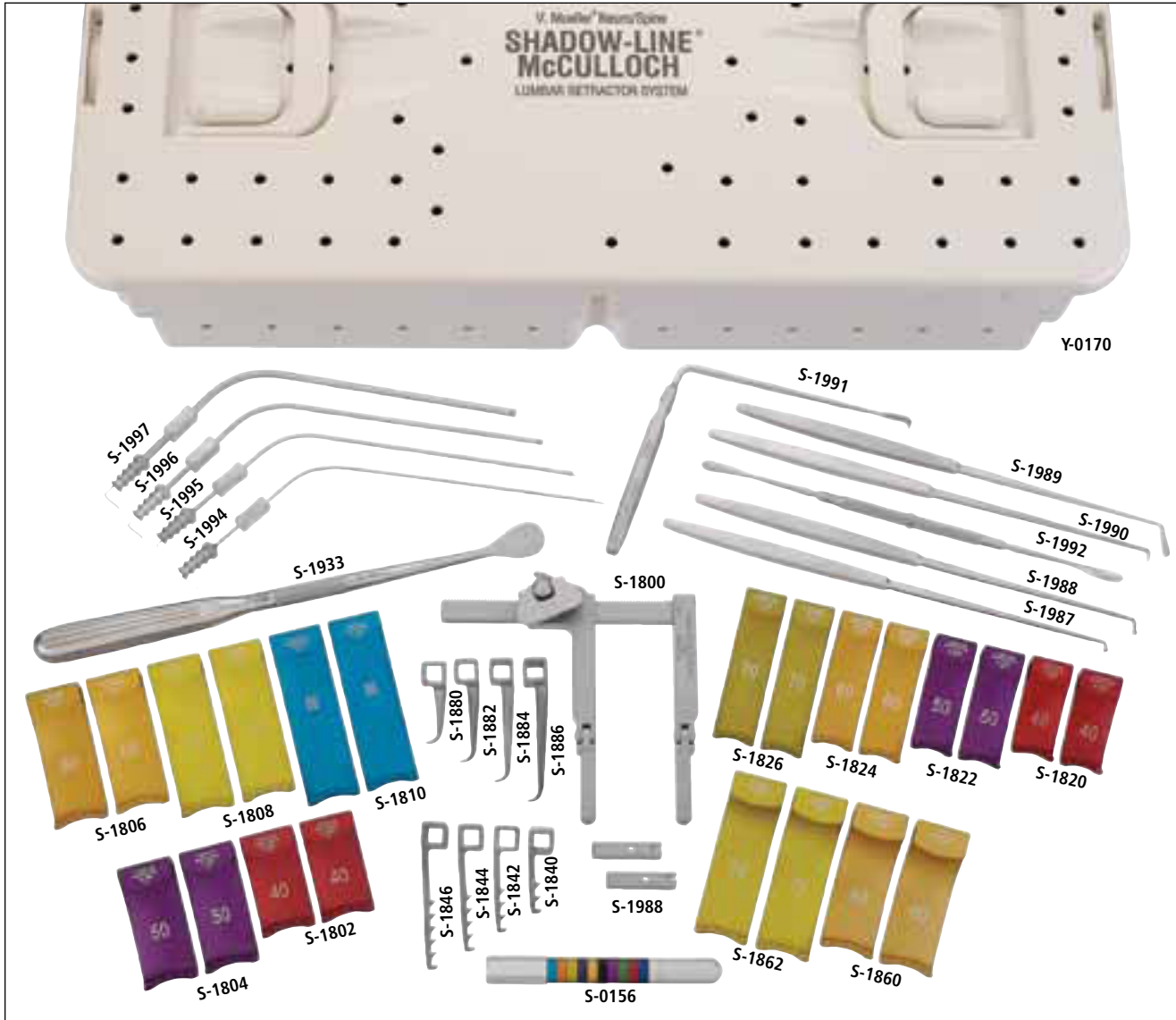

Developed in collaboration with Dr. McCulloch, the Shadow-Line® McCULLOCH Lumbar Retractor is the system of choice for anatomical visualization and operative site accessibility.

- As the first radiolucent retractor system of its class, the Shadow-Line® McCULLOCH Lumbar Retractor System combines a unique mix of blade designs that facilitates both direct visualization and intra-operative imaging of the spinal anatomy.
- Incorporating the well established Shadow-Line® color-coding standard, the Shadow-Line® McCULLOCH Lumbar Retractor System streamlines blade selection to optimize OR time efficiency.
- The blade attachment design also allows full interchangeability with existing McCULLOCH system components.

Shadow-Line® Mcculloch Retractor Set

Ensemble d'écarteurs Mcculloch Shadow-Line®
 Shadow-Line® Mcculloch-Wundspreizer-Set
 Set divaricatore Shadow-Line® Mcculloch
 Juego de separadores Mcculloch Shadow-Line®
 Conjunto de retractores Shadow-Line® Mcculloch
 Shadow-Line® Mcculloch リトラクターセット

SHADOW-LINE® McCULLOCH Lumbar Retractor Set

Set includes the following:

◆ Z-0160

Cat. No.	Description	Set Quantity
S-1989	Foraminal probe. Tip length 18mm. Overall length 9-1/2in (24.1cm).	1 each
S-1990	Angled manipulation hook. Tip 5mm wide. Overall length 9-1/2in (24.1cm).	1 each
S-1991	Nerve root retractor. Blade width 6mm. Shaft length 5in (12.7cm).	1 each
S-1992	Double-ended blunt elevator. Blade width 5.6mm. Working length 9in (22.9cm).	1 each
S-1993	COBB-type elevator. Semi-sharp blade 19mm wide. Overall length 10-1/2in (26.7cm).	1 each
S-1994	Suction tube. Working length 5in (12.7cm). 5Fr.	1 each
S-1995	Suction tube. Working length 5in (12.7cm). 7Fr.	1 each
S-1996	Suction tube. Working length 5in (12.7cm). 9Fr.	1 each
S-1997	Suction tube. Working length 5in (12.7cm). 12Fr.	1 each
S-1987	Ball tip probe. 4mm. Overall length 9-1/2in (24cm).	
S-1988	Ball tip probe. 7mm. Overall length 9-1/2in (24cm).	
Z-0161	SHADOW-LINE® McCULLOCH lumbar retractor basic set.	1 each

SHADOW-LINE® McCULLOCH Foraminal Probe

Overall length 9-1/2in (24.1cm).

S-1989 Tip length 18mm.

SHADOW-LINE® McCULLOCH Angled Manipulation Hook

Overall length 9-1/2in (24.1cm).

S-1990 Tip 5mm wide.

SHADOW-LINE® McCULLOCH Nerve Root Retractor

Shaft length 5in (12.7cm).

S-1991 Blade width 6mm.

SHADOW-LINE® McCULLOCH Double-Ended Blunt Elevator

Working length 9in (22.9cm).

S-1992 Blade width 5.6mm.

SHADOW-LINE® McCULLOCH COBB-Type Elevator

Overall length 10-1/2in (26.7cm).

S-1993 Semi-sharp blade 19mm wide.

SHADOW-LINE® McCULLOCH Extension Bar

S-1998

SHADOW-LINE® McCULLOCH Color-Coded Depth Gauge

Aluminum.

S-0156 For indications up to 100mm.

SHADOW-LINE® McCULLOCH Wide Muscle Blades

Aluminum. Blades 27mm wide.

S-1802 Blade length 40mm. Red.

S-1804 Blade length 50mm. Violet.

S-1806 Blade length 60mm. Gold.

S-1808 Blade length 70mm. Light green.

SHADOW-LINE® McCULLOCH Suction Tubes

Working length 5in (12.7cm).

S-1994 5Fr.

S-1995 7Fr.

S-1996 9Fr.

S-1997 12Fr.

SHADOW-LINE® McCULLOCH Lumbar Retractor Basic Set

Set includes the following:

Z-0161

Cat. No.	Description	Set Quantity
S-1800	Retractor frame.	1 each
S-1998	Extension bar.	2 each
S-0156	Depth gauge. Color-coded.	1 each
Y-0170	Instrument case.	1 each
S-1802	Wide muscle blade. Blade 40mm x 27mm wide. Red.	2 each
S-1804	Wide muscle blade. Blade 50mm x 27mm wide. Violet.	2 each
S-1806	Wide muscle blade. Blade 60mm x 27mm wide. Gold.	2 each
S-1808	Wide muscle blade. Blade 70mm x 27mm wide. Light green.	2 each
S-1820	Narrow muscle blade. Blade 40mm x 20mm wide. Red.	2 each
S-1822	Narrow muscle blade. Blade 50mm x 20mm wide. Violet.	2 each
S-1824	Narrow muscle blade. Blade 60mm x 20mm wide. Gold.	2 each
S-1826	Narrow muscle blade. Blade 70mm x 20mm wide. Light green.	2 each
S-1840	Multiple-toothed hook. Length 30mm.	1 each
S-1842	Multiple-toothed hook. Length 40mm.	1 each
S-1844	Multiple-toothed hook. Length 50mm.	1 each
S-1846	Multiple-toothed hook. Length 60mm.	1 each
S-1860	Offset blade. Blade 60mm x 27mm wide. Gold.	2 each
S-1862	Offset blade. Blade 70mm x 27mm wide. Light green.	2 each
S-1880	Hooks. Length 30mm.	
S-1882	Hooks. Length 40mm.	
S-1884	Hooks. Length 50mm.	
S-1886	Hooks. Length 60mm.	

SHADOW-LINE® McCULLOCH Retractor Frame

S-1800

SHADOW-LINE® McCULLOCH Narrow Muscle Blades

Aluminum. Blades 20mm wide.

S-1820 Blade length 40mm. Red.

S-1822 Blade length 50mm. Violet.

S-1824 Blade length 60mm. Gold.

S-1826 Blade length 70mm. Light green.

SHADOW-LINE® McCULLOCH Multiple-Toothed Hooks

S-1840 Length 30mm.

S-1842 Length 40mm.

S-1844 Length 50mm.

S-1846 Length 60mm.

SHADOW-LINE® McCULLOCH Offset Blades

Aluminum. Blades 27mm wide.

S-1860 Wide. 60mm x 27mm wide. Gold.

S-1862 Wide. 70mm x 27mm wide. Light green.

SHADOW-LINE® McCULLOCH Hooks

S-1880 Length 30mm.

S-1882 Length 40mm.

S-1884 Length 50mm.

S-1886 Length 60mm.

Écarteurs/Lames
Wundspreizer/Retraktoren/Klingen
Divaricatori/Lame
Separadores/Cuchillas
Retratores/Láminas
リトラクター/ブレード

SHADOW-LINE® McCULLOCH Longitudinal Retractor

S-1700

Double-hinged.



SHADOW-LINE® McCULLOCH Transverse Retractor

S-1701

Double-hinged.



SHADOW-LINE® McCULLOCH Cervical Blades

Aluminum. Blades 22mm wide.



SHADOW-LINE® McCULLOCH Narrow Muscle Blades

Aluminum. Blades 20mm wide.



Micro-Teeth	Blunt	Length	Color
S-1710	S-1720	30mm	Silver
S-1711	S-1721	35mm	Blue
S-1712	S-1722	40mm	Red
	S-1723	45mm	Green
S-1714	S-1724	50mm	Violet
S-1715	S-1725	55mm	Black
S-1716	S-1726	60mm	Gold
S-1717	S-1727	65mm	Navy
S-1718	S-1728	70mm	Light green

Part No.	Blade Length	Color
S-1820	40mm	Red
S-1822	50mm	Violet
S-1824	60mm	Gold
S-1826	70mm	Light green
S-1828	80mm	Turquoise

○ Instrument pictured

◆ Most widely used patterns

Blades/Hooks

Lames/Crochets
Klingen/Haken
Lame/Uncini
Cuchillas/Ganchos
Lâminas/Ganchos
ブレード/フック

SHADOW-LINE® McCULLOCH Wide Muscle Blades

Aluminum. Blades 27mm wide.



Part No.	Blade Length	Color
S-1802	40mm	Red
S-1804	50mm	Violet
S-1806	60mm	Gold
S-1808	70mm	Light green
S-1810	80mm	Turquoise

SHADOW-LINE® McCULLOCH Offset Retractor Blades

Aluminum. Blades 27mm wide.

Part No.	Blade	Color
S-1856	Wide. Blade 40 x 27mm wide.	Red
S-1858	Wide. Blade 50 x 27mm wide.	Violet
S-1860	Wide. 60mm x 27mm wide.	Gold
S-1862	Wide. 70mm x 27mm wide.	Light green
S-1864	Wide. Blade 80mm x 27mm wide.	Turquoise
S-1866	Wide. Blade 90 x 27mm wide.	Copper
S-1868	Wide. Blade 100 x 27mm wide.	Teal
S-1870	Wide. Blade 120 x 27mm wide.	Silver

SHADOW-LINE® McCULLOCH Offset Retractor Blades

Aluminum. Optional accessory (not included with Sets Z-0160 or Z-0161). 1 each.

Part No.	Blade	Color
S-1920	Narrow. 40mm x 20mm wide.	Red
S-1922	Narrow. 50mm x 20mm wide.	Violet
S-1924	Narrow. 60mm x 20mm wide.	Gold
S-1926	Narrow. 70mm x 20mm wide.	Light Green
S-1928	Narrow. 80mm x 20mm wide.	Turquoise
S-1930	Narrow. 90mm x 20mm wide.	Copper
S-1932	Narrow. 100mm x 20mm wide.	Teal
S-1934	Narrow. 120mm x 20mm wide.	Silver



SHADOW-LINE® McCULLOCH Hooks

S-1838
Blade length 20mm.

S-1880
Blade length 30mm.

S-1882
Blade length 40mm.

S-1884
Blade length 50mm.

S-1886
Blade length 60mm.

S-1888
Blade length 70mm.

S-1890
Blade length 80mm.

S-1892
Blade length 90mm.

S-1896
Blade length 100mm.



SHADOW-LINE® McCULLOCH Multiple-Tooth Hook Blade

S-1878
Blade length 20mm.

S-1840
Blade length 30mm.

S-1842
Blade length 40mm.

S-1844
Blade length 50mm.

S-1846
Blade length 60mm.

S-1848
Blade length 70mm.

S-1850
Blade length 80mm.

S-1852
Blade length 90mm.

S-1854
Blade length 100mm.



Sondes/Tubes d'aspiration/Boîtiers
 Sonden/Absaugschläuche/Behälter
 Sonde/Tubi di aspirazione/Custodie
 Sondas/Tubos de succión/Estuches
 Sondas/Tubos de sucção/Caixas
 プローブ/吸引チューブ/ケース

**SHADOW-LINE® McCULLOCH
 Hook Probes**

Angled. Overall length
 9-1/2in (24cm).

S-1772

Tip 2mm wide.

S-1773

Tip 3mm wide.

**SHADOW-LINE® McCULLOCH
 Suction Tubes**

Working length
 5in (12.7cm).

S-1755

5Fr.

S-1757

7Fr.

S-1759

9Fr.

S-1761

12Fr.

SHADOW-LINE® McCULLOCH Instrument Case

Part No.	Description
◆ Y-0170	Complete case includes base, lower insert, middle insert, upper insert and lid
Y-0170-2	Middle insert
Y-0170-4	Base

SHADOW-LINE® McCULLOCH Instrument Case

Case for the Shadow-Line® offset retractor set.

Part No.	Description
Y-0171	Complete case includes base, lower insert, middle insert, upper insert and lid.
Y-0171-0	Lid
Y-0171-1	Upper insert
Y-0171-3	Lower insert



V. MUELLER® McCULLOCH Universal Set

◆ **NL9700-N**

Includes the following:

- 1 each NL9701-H Hinged retractor frame
- 1 set NL9702-270 Wide muscle blades
- 1 set NL9702-200 Narrow muscle blades
- 1 set NL9702-130 Hook blades
- 1 set NL9702-050 Cervical blades
- 1 each NL9703-001 Nerve root retractor
- 1 each NL9704 Double-ended blunt elevator
- 1 each NL9707-002 COBB-type elevator
- 1 set NL9708-100 Long suction tubes
- 1 set NL9730 Probes
- 1 each NL5075 Lamina spreader

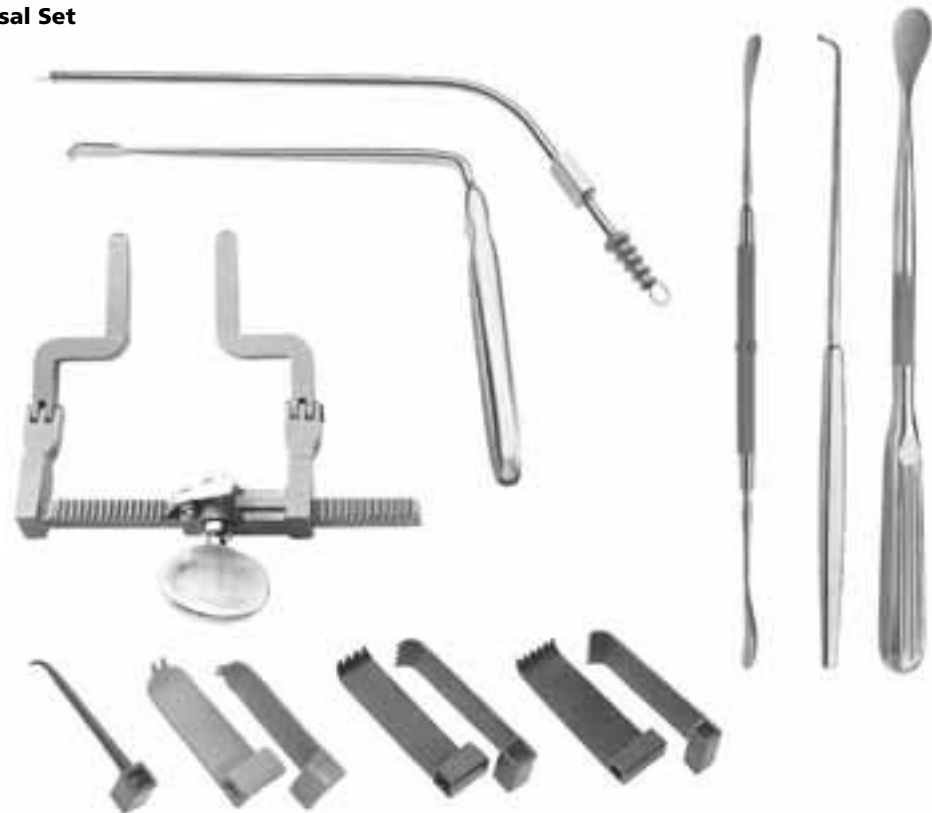

○ Instrument pictured

◆ Most widely used patterns

Retractors

Écarteurs
Wundspreizer/Retraktoren
Divaricatori
Separadores
Retratores
リトラクター

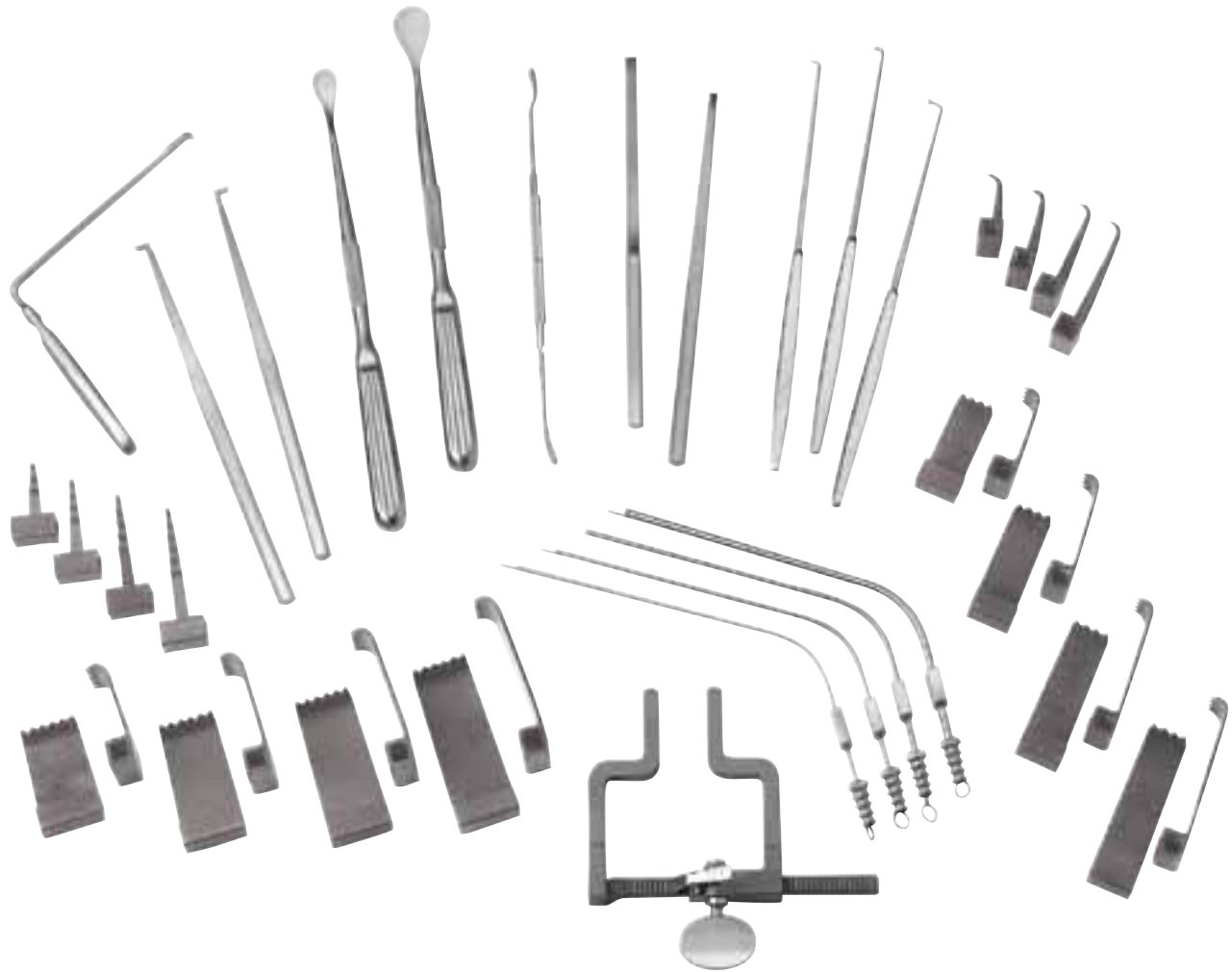

V. MUELLER® McCULLOCH Retractor Set

◆ (NL9700-1)

Includes the following:

- 1 each NL9701 Retractor frame
- 1 set NL9702 Retractor blades
- 1 each NL9703 Nerve root retractor
- 1 each NL9704 Double-ended blunt elevator
- 1 each NL9705-001 Osteotome, 4mm
- 1 each NL9705-002 Osteotome, 6mm
- 1 each NL9706-001 "Hockey stick" chisel, curved right
- 1 each NL9706-002 "Hockey stick" chisel, curved left
- 1 each NL9707-001 COBB-type elevator, blade 1/2in (1.3cm) wide
- 1 each NL9707-002 COBB-type elevator, blade 3/4in (1.9cm) wide
- 1 set NL9708 Suction tubes
- 1 each NL9709-001 Ball probe, 4mm
- 1 each NL9709-002 Ball probe, 7mm
- 1 each NL9710-005 Manipulation hook.

Écarteurs/Lames
Wundspreizer/Retraktoren/Klingen
Divaricatori/Lame
Separadores/Cuchillas
Retratores/Láminas
リトラクター/ブレード

V. MUELLER® McCULLOCH Retractor Set With Hinged Retractor Frame

◆ NL9700-UN

Same as NL9700 only includes Hinged Retractor Frame NL9701-H in place of Straight Retractor Frame NL9701.



McCULLOCH Wide Muscle Blade Set

Blades 2.7cm wide. Satin finish.



NL9702-370

Set. Includes 1 pair each of the following:

NL9702-116 (3cm)
NL9702-111 (4cm)
NL9702-112 (5cm)
NL9702-113 (6cm)
NL9702-114 (7cm)
NL9702-115 (8cm)

McCULLOCH Narrow Muscle Blade Set

Blades 2cm wide. Satin finish.



NL9702-300

Set. Includes 1 pair each of the following:

NL9702-126 (3cm)
NL9702-121 (4cm)
NL9702-122 (5cm)
NL9702-123 (6cm)
NL9702-124 (7cm)
NL9702-125 (8cm)

McCULLOCH Hook Set

Satin finish.



NL9702-330

Set. Includes 1 each of the following:

S-1878 (2cm)
S-1880 (3cm)
S-1882 (4cm)
S-1884 (5cm)
S-1886 (6cm)
S-1888 (7cm)

McCULLOCH Cervical Blade Set

Reverse bend with 2 teeth. Blades 2cm wide. Satin finish.



NL9702-150

Set. Includes 1 pair each of the following:

NL9702-155 (5cm)
NL9702-156 (6cm)
NL9702-157 (7cm)

Due to changing surgical trends, some products described in this catalog may be discontinued. Your V. Mueller sales representative may be able to suggest a suitable substitute if one is available.

Retractors/Blades

Écarteurs/Lames
Wundspreizer/Rektoren/Klingen
Divaricatori/Lame
Separadores/Cuchillas
Retradores/Láminas
リトラクター/ブレード

McCULLOCH Rigid Retractor Frame

Satin finish.



◆ **NL9701**

NL9701-H

Hinged frame.

McCULLOCH Retractor Blade Set

Satin finish.



◆ **NL9702-1**

Includes 1 set each of the following:
NL9702-110 Wide muscle blades
NL9702-120 Narrow muscle blades
NL9702-130 Hook blades
NL9702-140 Multi-toothed blades

McCULLOCH Wide Muscle Blade Set

Blades 2.7cm wide. Satin finish.



◆ **NL9702-110**

Set. Includes 1 pair each of the following:
NL9702-111 (4cm)
NL9702-112 (5cm)
NL9702-113 (6cm)
NL9702-114 (7cm)

McCULLOCH Narrow Muscle Blade Set

Blades 2cm wide. Satin finish.



◆ **NL9702-120**

Set. Includes 1 pair each of the following:
NL9702-121 (4cm)
NL9702-122 (5cm)
NL9702-123 (6cm)
NL9702-124 (7cm)

McCULLOCH Wide Muscle Blade Set

Blades 2.7cm wide. Satin finish.



◆ **NL9702-111**

Blade length 4cm. Pair.

◆ **NL9702-112**

Blade length 5cm. Pair.

◆ **NL9702-113**

Blade length 6cm. Pair.

◆ **NL9702-114**

Blade length 7cm. Pair.

◆ **NL9702-116**

Blade length 3cm. Pair.

◆ **NL9702-115**

Blade length 8cm. Pair.

McCULLOCH Narrow Muscle Blade Set

Blades 2cm wide. Satin finish.



◆ **NL9702-121**

Blade length 4cm. Pair.

◆ **NL9702-122**

Blade length 5cm. Pair.

◆ **NL9702-123**

Blade length 6cm. Pair.

◆ **NL9702-124**

Blade length 7cm. Pair.

◆ **NL9702-126**

Blade length 3cm. Pair.

◆ **NL9702-125**

Blade length 8cm. Pair.

McCULLOCH Hook Blades

Satin finish.

**NL9702-230**

Set. Includes 1 each of the following:
S-1880 (3cm)
S-1882 (4cm)
S-1884 (5cm)
S-1886 (6cm)

McCULLOCH Multiple-Tooth Blade Set

Satin finish.

**NL9702-240**

Set. Includes 1 each of the following:
S-1840 (3cm)
S-1842 (4cm)
S-1844 (5cm)
S-1846 (6cm)

NL9702-140

Set. Includes 1 each of the following:
S-1878 (2cm)
S-1840 (3cm)
S-1842 (4cm)
S-1844 (5cm)
S-1846 (6cm)
S-1848 (7cm)

McCULLOCH Cervical Blades

Reverse bend with 2 teeth. Blades 2cm wide. Satin finish.

**NL9702-155**

Blade length 5cm. Pair.

NL9702-156

Blade length 6cm. Pair.

NL9702-157

Blade length 7cm. Pair.

To learn how the IMPRESS system can help improve process performance, reduce immediate-use steam sterilization, decrease case delays, and improve patient care by monitoring instrument flow within your facility, contact your V. Mueller sales representative.

McCULLOCH Probes

Overall length 9-1/2in (24.1cm).

NL9730

Set. Includes 1 each of the following:

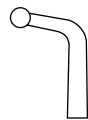
**NL9709-008**

Angled ball tipped probe, 8mm from shaft to ball.

**NL9710-002**

Angled manipulation hook, 2mm tip.

**NL9710-003**

Angled manipulation hook, 3mm tip.

**NL9710-005**

Angled manipulation hook, 5mm tip.

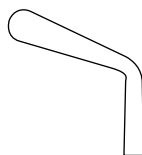
**NL9715**

Foraminal probe, 18mm tip.



Probes/Suction Tubes/Elevators/Osteotomes/Chisels

Sondes/Tubes d'aspiration/Élévateurs/Ostéotomes/Ciseaux
 Sonden/Absaugschläuche/Heber/Osteotome/Meißel
 Sonde/Tubi di aspirazione/Elevatori/Osteotomi/Scalpelli
 Sondas/Tubos de succión/Elevadores/Osteótomos/Cinceles
 Sondas/Tubos de sucção/Elevadores/Osteótomos/Cinzéis
 プロープ/吸引チューブ/エレベーター/骨刀/のみ

McCULLOCH Angled Ball-Tipped Probes

Overall length 9-1/2in (24.1cm).

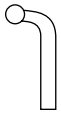

NL9709-001

Tip length 4mm.

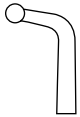

NL9709-002

Tip length 7mm.



McCULLOCH Suction Tubes

Working length 5in (12.7cm).

NL9708

Set. Includes 1 each of the following:

Cat. No.	Size
NL9708-005	(5Fr.)
NL9708-007	(7Fr.)
NL9708-009	(9Fr.)
NL9708-012	(12Fr.)

McCULLOCH Long Suction Tubes

Working length 5-3/4in (14.6cm).

NL9708-100

Set. Includes 1 each of the following:

Cat. No.	Size
NL9708-105	(5Fr.)
NL9708-107	(7Fr.)
NL9708-109	(9Fr.)
NL9708-112	(12Fr.)

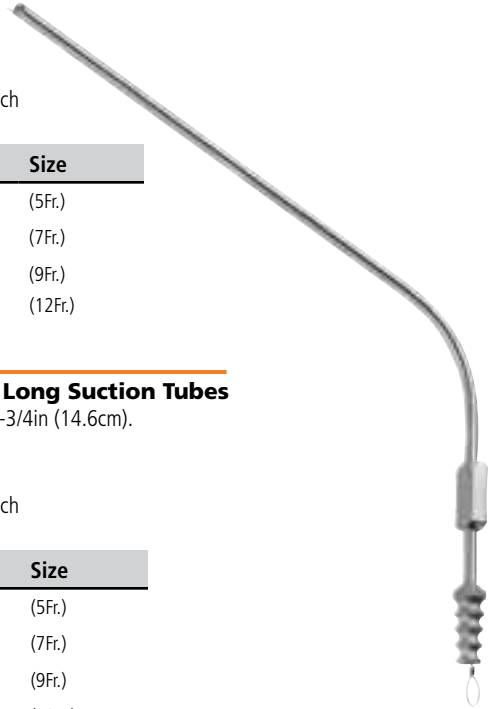

McCULLOCH Double-Ended Blunt Elevator

Blades 5.6mm wide.

NL9704

Working length 9in (22.9cm).



Osteotomes

Overall length 8-1/2in (21.6cm).

NL9705-001

4mm.

NL9705-002

6mm.



McCULLOCH "Hockey Stick" Chisels

5mm. Overall length 8-1/2in (21.6cm).

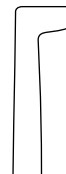

NL9706-001

Curved right.

NL9706-002

Curved left.

