

Ophthalmic Instruments

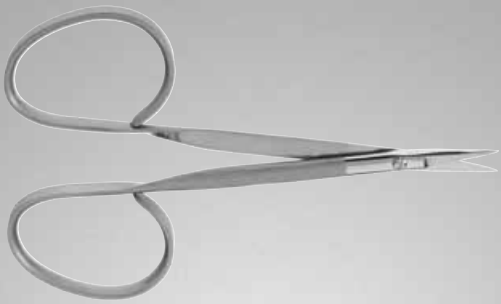

Specula

Spéculum
Spekula
Speculum
Espéculos
検鏡

PIERSE Eye Speculum

Open wire blades
11mm long x 7mm deep.



OP0905-951

Overall length
1in (3cm).

BARRAQUER Eye Speculum

Wire blades
5mm long x 4mm deep.

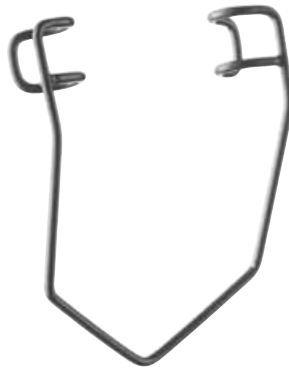

OP0905-921

Overall length
1-1/8in (2.8cm).

ALFONSO Eye Speculum

Opens 27mm wide.
Overall length
1-3/4in (4.5cm).



OP0905-915

Extra-small size.
Blades 5mm wide.

BARRAQUER Wire Eye Speculum

Heavy wire blades
13mm long x 5mm deep.
Mirror finish.

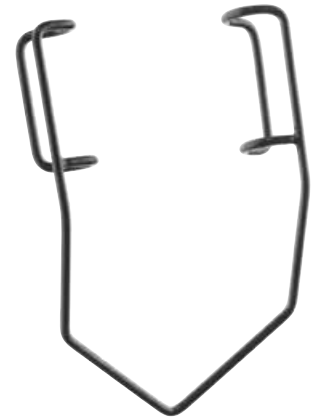

OP0905-451

Overall length
1-3/4in (4.5cm).

BARRAQUER Wire Specula

Mirror and Satin finish.
Overall length
1-1/2in (3.8cm).



OP26-002

Solid blades 1.5cm x 5mm x 7mm wide.

OP26-003

Solid blades 1.2cm x 4mm x 7mm wide.

BARRAQUER Wire Specula

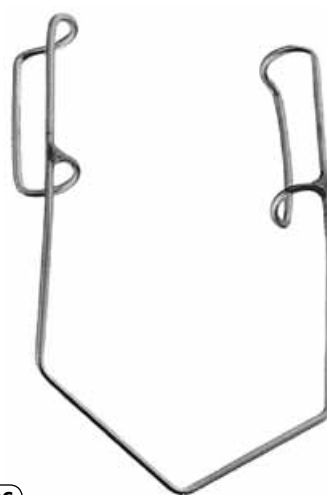

OP26

Wire blades 1.3cm x 6mm x 8mm wide.
Overall length 1-5/8in (4cm).

OP26-001

Wire blades 1cm x 6mm x 8mm wide.
Overall length 1-1/2in (3.8cm).

SIMCOE-BARRAQUER Eye Speculum

Open blades with lifting wings, 19mm wide.



OP23

Overall length
1-9/16in (4cm).

KRATZ-BARRAQUER Wire Eye Speculum

Wire blades 14mm long x 7mm deep. Adult.

**OP0905-601**Overall length
1-3/4in (4.4cm).**KRATZ-BARRAQUER Wire Speculum**

Open blades 15mm wide.

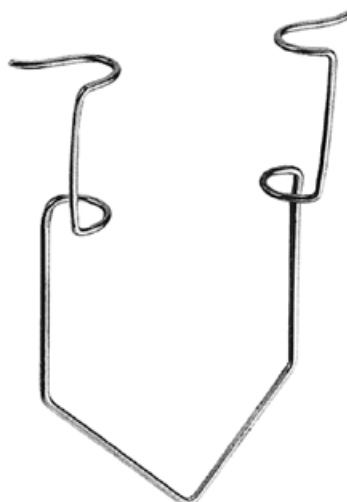
**OP24**Overall length
1-1/2in (3.8cm).**GRANDON-BARRAQUER Speculum**Wire blades 15mm long x 7mm deep.
Overall length 2-1/4in (5.7cm).**OP0905-471**

With suture notches.

McINTYRE Wire Eye Speculum12mm V-shaped blades. Gently curved springs.
Overall length 1-3/4in (4.5cm).**OP0905-701**

Closed.

OP0905-702

Open.

NEVYAS Wire Eye Speculum

Wire blades 14mm long x 7mm deep.

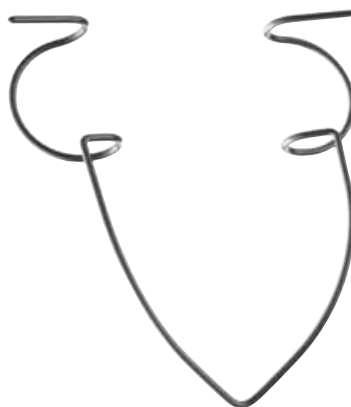
**OP0905-721**Overall length
1-3/4in (4.4cm).**Temporal Wire Eye Speculum**

Angled wire blades 14mm long x 7mm deep.

**OP0905-501**Overall length
1-3/4in (4.4cm).

Specula

Spéculum
Spekula
Speculum
Espéculos
Espéculos
検鏡

Temporal Wire Eye Speculum

Solid blades
14mm long x 7mm deep.



OP0905-502

Overall length
1-3/4in (4.4cm).

Temporal Wire Eye Speculum

Wire blades
14mm long x 7mm deep.



OP0905-503

Overall length
1-3/4in (4.4cm).

THORNTON Wire Eye Speculum

Wire blades with wings 15mm long x 7mm deep.

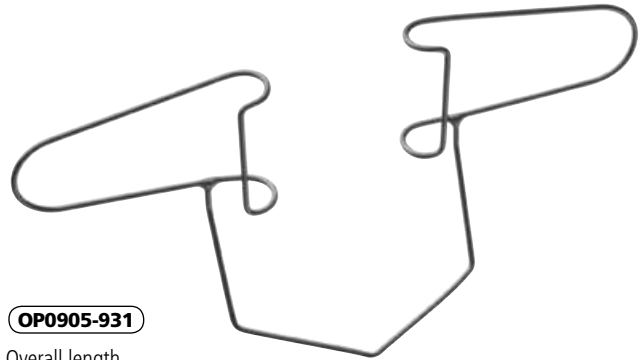

OP0905-931

Overall length
1-3/4in (4.4cm).

SAUER-SCHAFFER Eye Specula

Overall length 1in (2.5cm).



OP0905-961

Solid blades 4mm long x 4mm deep.

OP0905-962

Solid blades 6mm long x 4mm deep.

SAUER Eye Speculum

Solid blades 1cm long x 4.5mm deep.



OP25

Overall length
1-1/4in (3.2cm).

Cook Eye Specula



OP0905-771

Blades 10mm long x 7mm deep.
Overall length
2-1/8in (5.5cm).

OP0905-772

Blades 15mm long x 7mm deep.
Overall length
2-3/8in (6cm).

COOK Eye Speculum

Solid blade with lock nut.

**OP27**Blades 7.5mm long x 5mm deep.
Overall length
1-1/2in (3.8cm).**MURDOCH Eye Specula**

Fenestrated blades. With locking screw.

**OP0905-801**Blades 13mm long x 5mm deep, No. 2.
Overall length
1-3/4in (4.5cm).**OP0905-802**Blades 15mm long x 7mm deep, No. 3.
Overall length
2-1/4in (5.7cm).**MELLINGER Eye Speculum**Solid blades 15mm long x 7mm deep.
Overall length 2-3/4in (7cm).**OP0905-981**

With self-locking mechanism.

MURDOCK-WIENER Eye SpeculumSolid blade extension for covering eyelashes.
Open blades 15mm x 5.5mm x 6.5mm wide.**OP160**Overall length
1-7/8in (4.8cm).**CASTROVIEJO Eye Speculum**

With adjustment mechanism. Fenestrated blades 14mm long x 5mm deep. Small No. 1.

**OP0905-901**Overall length
3in (7.5cm).**CASTROVIEJO Eye Speculum**

Curved arms. Open blades 15mm long x 7.5mm deep.

**OP70**Overall length
3-1/4in (8.3cm).

Specula

Spéculum
Spekula
Speculum
Espéculos
Espéculos
検鏡

LANGE Eye Speculum

Solid blades 18mm long x 6.5mm deep.



OP10

Overall length
3-1/2in (8.9cm).

LANCASTER Eye Speculum

Solid blades 15mm long x 7mm deep.



OP30

Overall length
3in (7.6cm).

WEEKS Eye Speculum

Open blades 25mm x 8mm wide.



OP80

Overall length
3in (7.6cm).

LIEBERMAN Eye Speculum

K-wire with adjustable mechanism.
Blades 15mm long x 7mm deep.



OP0905-851

Overall length
3-1/8in (8cm).

LIEBERMAN Eye Speculum

V-wire with adjustable mechanism.
Blades 13mm long x 7mm deep.



OP0905-852

Overall length
3-1/8in (8cm).

LIEBERMAN Eye Speculum

Angled 45°. Solid blades
15mm long x 7mm wide.



OP0905-853

Overall length
3-1/8in (7.8cm).

LIEBERMAN Open Wire Eye Speculum

With aspirator. Open wire blades
15mm long x 7mm deep.

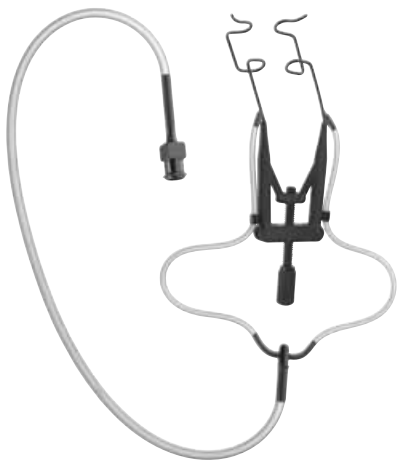
**OP0905-971**

Large.

MAUMENEE-PARK Eye Specula

Locking screws on outside of branches, with
guard bar over locking assembly. Blades 14mm
wide. Working length 3-1/4in (8cm).

**OP112**

Fenestrated blades.

OP113

Solid blades.

GUYTON-PARK Eye Specula

No locking screws. With suture posts. Blades
14mm wide. Working length 3-3/8in (8.5cm).

**OP120**

Fenestrated blades.

KNAPP Eye Speculum

Original model. Open blades
15mm x 6.5mm wide.

**OP50**

Overall length
3-1/4in (8.3cm).

SCHOTT Eye Speculum

Rotatable adjustment mechanism.
Wire blades 55mm x 11mm.

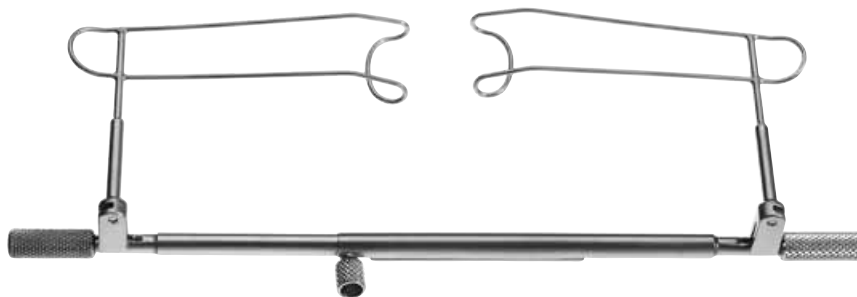
**OP0905-911**

Overall length
4-1/8in (10.5cm).

Specula/Fixation Rings/Retractors

Spéculum/Anneaux de fixation/Écarteurs
 Spekula/Fixierungsringe/Wundspreizer/Retraktoren
 Speculum/Anelli di fissazione/Divaricatori
 Espéculos/Anillos de fijación/Separadores
 Espéculos/Anéis de fixação/Retratores
 検鏡/固定リング/リトラクター

LISTER-BURCH Eye Speculum

Solid blades 21mm x 6mm wide.



OP20

Overall length
 3-1/2in (8.9cm).

WILLIAMS Eye Speculum

With screw lock. Open blades
 12.5mm x 7mm wide.



OP60

Overall length
 3-3/8in (8.3cm).

Flieringa Fixation Rings



OP165-015

15mm diameter.

OP165-016

16mm diameter.

OP165-017

17mm diameter.

OP165-018

18mm diameter.

OP165-019

19mm diameter.

OP165-020

20mm diameter.

OP165-021

21mm diameter.

OP165-022

22mm diameter.

Serrefine



OP180

Overall length
 1-3/8in (3.5cm).



TENNANT Lid Retractor

Solid blades 14mm long x 7mm deep.

OP0905-751

Set of two.



JAFFE Wire Lid Retractor

Large. Wire blades 14mm long x 7mm deep.

OP0906-301

Set of two.



Écarteurs
Wundspreizer/Retraktoren
Divaricatori
Separadores
Retratores
リトラクター

JAEGER Lid Plate

OP291

Overall length
4-3/8in (11cm).



FISHER Lid Retractor

Blade 15mm wide.

OP0906-551

Overall length
5-1/4 (13.3cm).



DESMARRES Lid Retractors

Overall length 5-1/2in (14cm).

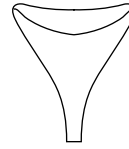

OP190

Large, No. 3.
16mm wide.



OP192

Small, No. 1.
12mm wide.

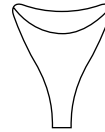

OP191

Medium, No. 2.
13mm wide.



OP193

Extra-small, No. 0.
9mm wide.



KNAPP Lacrimal Retractor

Four prongs. Blunt.

OP0906-521

Overall length
5-1/8in (13.1cm).



KNAPP Lacrimal Sac Retractor

Four prongs. 1cm wide. Sharp.

OP300

Overall length
5-1/2in (14cm).



AGRIKOLA Lacrimal Sac Retractor

Curved, 3 x 3 semi-sharp prongs.
Finger grips and screw lock.



OP330

Overall length
1-5/8in (4.1cm).

OPHTHALMIC

Retractors

Écarteurs
Wundspreizer/Retraktoren
Divaricatori
Separadores
Retratores
リトラクター

STEVENSÓN Lacrimal Sac Retractor
3 x 3 sharp prongs.



OP360
Overall length
3-1/4in (8.3cm).

GOLDSTEIN Lacrimal Sac Retractor
3 x 3 sharp prongs, 5mm long.



OP320-1
Overall length
1-1/2in (3.8cm).

BRAWLEY Scleral Wound Retractor
Light, delicate, non-magnetic. Nickel, Silver.



OP370
Overall length
1-1/4in (3.2cm).

GRAETHER Collar Button
Round, knurled handle.
Overall length
4-3/4in (12cm).



OP0922-201
Shaft angled 45°.
10mm from tip to bend.



OP0922-202
Straight.

GRAETHER Collar Button Iris Retractors
23GA. Mirror finish.



OP2528
Straight.

OP2528-001
Straight, roughened button.

OP2528-002
Angled 30°.

OP2528-003
Angled 30°, roughened button.



RIZZUTI Iris Retractors and Expressors
Malleable shaft.
Mirror and Satin finish.

OP6581
Retractor 2.5mm wide.



Lames/Couteaux/Élévateurs
 Klingen/Messer/Heber
 Lame/Bisturi/Elevatori
 Cuchillas/Cuchillos/Elevadores
 Lâminas/Facas/Elevadores
 ブレード/ナイフ/エレベーター

Razor Blade Breaker and Holder

With push-pull lock ferrule.
 Closes to small.
 Round serrated handle.
 Short model.

OP1275

Overall length
 4-1/4in (10.8cm).



Stainless Steel Breakable Blades

Non-sterile.



OP0919-251

Ten blades per package.

MAUMENEE Goniotomy Knife



OP0901-301

23GA. 26mm.



PAUFIQUE Duredge Knife

Sharp, angled blade,
 3mm long x 1.5mm wide.
 Flat, smooth handle.

OP0919-001

Overall length
 4-1/2in (11.4cm).



TOOKE Cornea Splitting Knife

Blade 2.5mm wide.

OP1120

Overall length
 4-1/2in (11.4cm).



GILL Corneal Knife

Blade with curved
 cutting edge
 18mm long x 3mm wide.

OP0919-051

Overall length
 4-7/8in (12.4cm).



LOCKE Elevators

OP1083-01

Narrow.
 Overall length
 5in (12.7cm).

OP1083-02

Wide.
 Overall length
 5in (12.7cm).



Knives

Couteaux
Messer
Bisturi
Cuchillos
Facas
ナイフ

FUKASAKU Hockey Knife

Sharp 3mm front edge.
Semi-sharp
6mm bottom edge.

OP0919-081

Overall length
5in (12.7cm).



MARTINEZ Corneal Dissector Knife

Double-ended.
Angled sharp blades
11mm long x 3mm wide.
Flat handle.

OP0919-101

Overall length
5in (12.7cm).



ELLIS Foreign Body Spud

Small, curved,
rounded blade.
Flat handle.

OP0919-121

Overall length
4-1/2in (11.4cm).



Foreign Body Spuds

Encased in double-ended handle.
Mirror and Satin finish.
Overall length 4in (10.2cm).

OP1500

Curved needle spud
3mm x 5mm and
flat spud 2mm x 18mm.

OP1500-001

Curved needle spud only.
3mm x 5mm wide.
Working length 29mm.
For OP1500 and OP1502.

OP1500-002

Flat spud only.
2mm x 18mm.
Working length 27mm.
For OP1500 and OP1501.



Curved Needle Spud

Encased in single-ended handle.
Tip 5mm x 3mm wide.
Mirror and Satin finish.

OP1502

Overall length
4in (10.2cm).



Flat Spud

Encased in single-ended handle.
Tip 18mm x 2mm wide.
Mirror and Satin finish.

OP1501

Overall length
5-1/8in (13cm).



WALTER Corneal Spuds

Arrow tip, 2mm wide.
Mirror and Satin finish.
Overall length
4-5/8in (11.7cm).

OP1600

Straight.



DIX Foreign Body Spud

Flat. 20mm x 1.6mm wide.

OP1530

Overall length
4-3/4in (12.1cm).

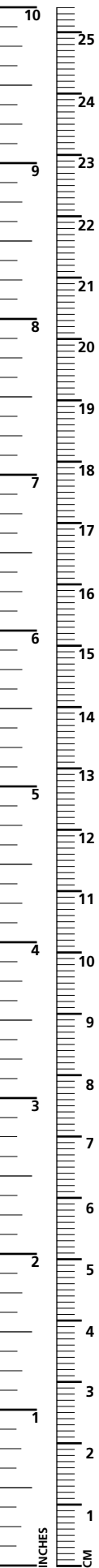

DAVIS Foreign Body Spud

Flat tip, 8mm wide.
Mirror and Satin finish.

OP1540

Overall length
4-3/4in (12.1cm).



CORBETT Foreign Body Spud

Blade slightly curved-on-flat.
Tip 2mm wide.
Mirror and Satin finish.

OP1610

Overall length
4-3/4in (12.1cm).



LAFORCE "Golf Club" Knife Spud

Round blade 2mm.
Mirror and Satin finish.

OP1620

Overall length
4-3/4in (12.1cm).



FRANCIS Knife Spud

Blade 1.5mm x 1mm wide,
angled 65°. Mirror and Satin finish.

OP1630

Overall length
4-3/4in (12cm).



GREEN Corneal Curette

Round cup,
diameter 1mm.

OP1740

Overall length
4-7/8in (12.4cm).



ANIS Capsule Scrubber

Ball tip. Gently curved flexible
shank with roughened tip.

OP0919-801

Overall length
4-1/2in (11.4cm).



NIGHTINGALE Capsule-Polishing Curette

Open ring with
semi-sharp edge.
Diameter 1.75mm.



OP0919-551

Overall length
4-7/8in (12.4cm).



Foreign Body Curette

Cup size 0.5mm.
Straight, 31mm shaft.
Flat handle.



OP0919-501

Overall length
5in (12.7cm).



OPHTHALMIC

Curettes/Lens Loop

Curettes/Anse de lentille
Küretten/Linsenöse
Curette/Anse per nucleo
Curetas/Lentes
Curetas/Aro da lente
キュレット/レンズループ

MEYHOEFFER Chalazion Curettes

Overall length 5in (12.7cm).

OP1780

Large cup,
diameter 3.5mm.

OP1781

Medium cup,
diameter 2.5mm.

OP1782

Small cup,
diameter 2mm.

OP1783

Extra-small cup,
diameter 1.5mm.



SKEELE Chalazion Curette

Serrated cup,
diameter 2mm.

OP1790

Overall length
5in (12.7cm).



HEATH Chalazion Curettes

One sharp,
one dull edge.
Angled 30°.

OP1810

4mm cup.
Overall length
5in (12.7cm).

OP1811

2mm cup.
Overall length
4-1/2in (11.5 cm).



GILLS-WELSH Lens Loop

Olive tip on opposite end.
7mm x 5mm wide thin loop.
Mirror and Satin finish.

OP9301

Overall length
4-3/4in (12.1cm).



NEW ORLEANS Lens Loop

Long oval, very light.
10mm x 5mm wide loop.
Mirror and Satin finish.

OP2177

Overall length
5-3/8in (13.7cm).



ARLT Lens Loop

Slightly curved,
serrated loop,
14mm x 4mm wide.
Mirror and Satin finish.

OP1920

Overall length
5-3/8in (13.7cm).



KEENER-ARIT Lens Loop

Strong curve,
serrated loop,
3mm wide.

OP0921-801

Overall length
5-3/8in (13.5cm).



KIRBY Lens Loop

Loop 6.5mm x 4mm wide.
Round knurled handle.

OP2800-007

Overall length
5-1/2in (14cm).



Anse de lentille/Spatules
Linsenöse/Spatel
Anse per nucleo/Spatole
Lentes/Espátulas
Aro da lente/Espátulas
レンズループ/ヘラ

KIRBY Lens Loop and Muscle Hook

Double-ended with 8mm x 5mm wide loop and 10mm long muscle hook.

OP0921-901

Overall length 5-7/8in (15cm).



LEWIS Lens Loops

Loop 6mm x 8mm. Overall length 5-1/2in (14cm).

OP1900

Serrated loop.

OP1901

Plain loop.



KANSAS Lens Loop

Loop 3mm wide. Serrated.

OP0921-851

Overall length 5-3/4in (14.5cm).



SIMCOE Nucleus Loop

Left and right loops, double-ended, 20mm x 4mm wide. Round, knurled handle. Matte and Mirror finish.

OP1850

Overall length 5-1/2in (14cm).



FISHER Spoon and Needle

Double-ended with 14mm x 5mm wide curved blade. Overall length 5-1/2 in (14cm).

OP0922-051

Flat, serrated handle.



WRIGHT Fascia Needle

Curved tip, 1.2mm wide. Mirror and Satin finish.

OP1940

Overall length 5-1/4in (13.3cm).



CLEASBY Iris Spatula

12mm angled tip with gently curved blade. Overall length 3-1/2in (9cm).

OP0920-201

Short, hexagonal handle.



BARRAQUER Iris Spatula

Angled tip with gently curved blade. Short, hexagonal handle. Overall length 3-1/2in (8.8cm).

OP0920-101

Blade 15mm x 0.5mm wide.

OP0920-102

Blade 15mm x 0.25mm wide.



Spatulas

Spatules
Spatel
Spatole
Espátulas
Espátulas
ヘラ

BARRAQUER Iris Spatula

.25mm diameter.

OP0920-103

Overall length
4-3/4in (12.2cm).



TROUTMAN-BARRAQUER Iris Spatula

Blade 15mm x 1mm wide.
Hexagonal handle.
Angled.

OP2033

Overall length
3-3/4in (9.5cm).



BARRAQUER Iris Spatula

15mm x 1mm wide.
Hexagonal handle.
Angled.

OP2035

Overall length
4-5/8in (11.7cm).



McPHERSON Iris Spatula

Blade 20mm x 1mm wide.

OP2032

Overall length
4-1/2in (11.4cm).

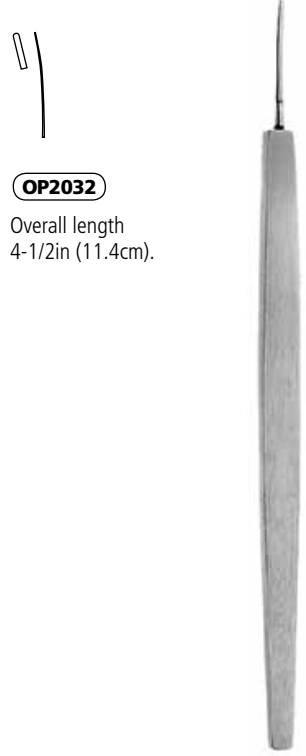

Iris Spatula

Blade 33mm x 2mm wide.
Flat, smooth handle.

OP0920-001

Overall length
5-1/8in (13cm).



CULLER Iris Spatula

Blade 28mm x 1mm wide.
Flat, smooth handle.

OP0920-051

Overall length
5-1/8in (13cm).



Iris Spatula

Malleable blade
30mm x 1mm wide.
Flat handle.

OP0920-081

Overall length
5-1/8in (13cm).



BARRAQUER Cyclodialysis Spatula

Smoothly pointed tip
15mm x 0.5mm wide.
Round, knurled handle.

OP0920-301

Overall length
4-5/8in (11.75cm).

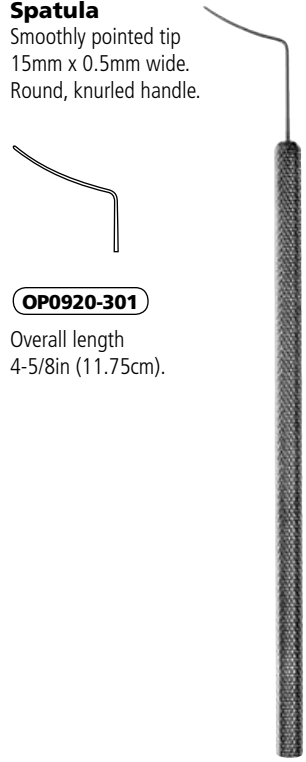

**CASTROVIEJO Cyclodialysis
Spatulas**

Double-ended.
Overall length
5in (12.7cm).

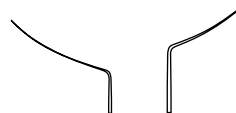

OP2052

Flat spud only.
2mm x 18mm.
Working length 27mm.
For OP1500 and OP1501.

OP2053

1cm x 0.5mm wide and
1.5cm x 0.5mm wide.

OP2054

1cm x 0.75mm wide and
1.5cm x 0.75mm wide.



WHEELER Cyclodialysis Spatula

Blade 35mm x 2mm wide.
Mirror and Satin finish.



OP2010

Overall length
5-1/8in (13cm).



**ELSCHNIG Cyclodialysis
Spatula**

Single-ended, angled 25°.
Length of tip from bend 1cm.
Mirror and Satin finish.



OP2040

Overall length
5in (12.7cm).



**ELSCHNIG
Cyclodialysis
Spatula**

Double-ended.
Tip 1mm wide.
Stainless Steel
and Silver.

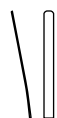

OP2080

Overall length
5-1/4in (13.3cm).



**CASTROVIEJO
Cyclodialysis
Spatulas**

Single-ended,
flat, with
semi-sharp sides.
Overall length
5-3/8in (13.7cm).

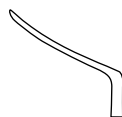

OP2050

Blade 15mm.



OBSTBAUM Lens Spatula

Angled blade,
0.25mm wide.



OP0920-401

Overall length
5in (12.7cm).



KOCH Nucleus Spatula

Gently curved with
duckbill tip.
Overall length
4-3/4in (12cm).



OP0921-401

Smooth.

OP0921-402

With Notches.



Spatulas

Spatules
Spatel
Spatole
Espátulas
Espátulas
ヘラ

NAGAHARA Nucleus Spatula

Flat inferior edge.



OP0921-501

Overall length
4-3/8in (11cm).



HIRSCHMAN Lens Spatula

Notched tip, 6mm.

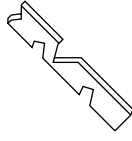

OP2501

Overall length
4-1/2in (11.4cm).



KNOLLE Lens Nucleus Spatula and Gauge

Narrow spatula blade, 30mm length.
Markings at 5, 6 and 7mm from tip.
Round, knurled handle.

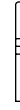

OP0920-991

Overall length
4-7/8in (12.5cm).



JAFFE Lens Spatula

Tip 0.5mm wide.
Flat, smooth blade.



OP0920-601

Overall length
5in (12.7cm).



Rake Membrane Spatula

Serrated rake tip.
20GA shaft.



OP0924-101

Overall length
4-7/8in (12.5cm).



ROWLE Phaco Spatula

Double-ended. One end
ROSEN Phaco Splitter,
other end BECHERT
Nucleus Splitter.

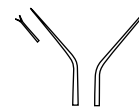

OP0924-451

Overall length
5-1/2in (14cm).



NICHAMIN Double-Ended Nucleus Chopper-Spatula

Wedge-shaped chopper with rounded 0.5mm spatula tip.

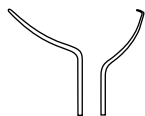

OP0925-501

Overall length 5-1/2in (14cm).



PATON Spatula and Spoon

OP0922-001

Overall length 5-1/2in (14cm).



NAGAHARA Nucleus Chopper

1.25mm tip. Blade offset at 60° angle. Round, knurled handle. Overall length 4-3/4in (12cm).



OP0925-601

Left.

OP0925-602

Right.



JOHNSON Spatula

Blade length 10mm x 0.25mm wide. Round, knurled handle.



OP0920-801

Overall length 4-1/2in (11.4cm).



MAUMENEE-BARRAQUER Vitreous Sweep Spatula

10mm long tip. Gently curved, round, knurled handle. Overall length 4-3/4in (12.1cm).



OP0920-501

With indentation on right side.



OLK Angled Retinal Spatula

0.5mm triangular tip. 4mm flat surface. Round, knurled handle. Overall length 4-3/4in (12cm).



OP0924-001

Tip angled 110°.

OP0924-002

Tip angled 150°.

OP0924-003

Tip angled 130°.



KIMURA Platinum Spatula

Round end. Overall length 6-1/8in (15.5cm).



OP2036

Tip 3.5mm wide.



KANSAS Nucleus Spatula

Solid. Overall length 5-1/4in (13.2cm).



OP0920-903

For right-handed surgeons.

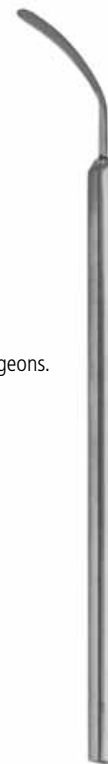

Manipulators

Téléthèses
 Manipulatoren
 Manipolatori
 Manipuladores
 Manipuladores
 マニピレーター

DRYSDALE Nucleus Manipulator

Paddle-shaped tip.



OP0921-101

Overall length
 4-3/8in (11cm).



BECHERT Nucleus Rotator

Jaw size 1mm wide.
 Matte and Mirror finish.



OP2220

Overall length
 4-1/2in (11.4cm).



Titanium BECHERT Nucleus Rotator

7mm angled tip.



OP0916-951

Overall length
 4-3/4in (12cm).

titanium



JAFFE-BECHERT Lens Nucleus Rotator

Blunt forked tip.
 Angled. 9mm.



OP0921-001

Overall length
 4-1/2in (11.5cm).



PISACANO Nucleus Rotator

Flat, blunt tip.



OP0921-151

Overall length
 4-1/2in (11.5cm).



CLAYMAN Nucleus Rotator

0.5mm wide with
 V-notched tip.



OP0921-301

Overall length
 4-3/4in (12cm).



TENNANT Nucleus Manipulator

Ball-shaped tip.



OP0921-201

Overall length
 4-3/4in (12cm).



KANSAS Nucleus Bisector

Blade length
 10mm. Angled.
 Semi-sharp blade.



OP0920-905

Overall length
 4-1/2in (11.5cm).



Crochets
Haken
Uncini
Ganchos
Ganchos
フック

SIEPSER Controller

Trumpet-shaped tip.



OP0921-051

Overall length
4-3/4in (12cm).



Twist Fixation Hooks

Overall length
4-3/8in (11cm).



OP0924-501

Right.
Large. 0.5mm.

OP0924-502

Left.
Large. 0.5mm.

OP0924-503

Right.
Small. 0.3mm.

OP0924-504

Left.
Small. 0.3mm.



MANSON Double-Ended Strabismus Hook

3mm wide forked
angled blades.
Blade spread 7mm.
Overall length
4-3/8in (11cm).

OP0924-651

Flat, serrated handle.



FUKASAKU Snapper Hooks

Overall length
4-3/8in (11cm).



OP0924-201

Wedge-shaped
inferior edge
with blunt tip
and front notch.



OP0924-202

Wedge-shaped
inferior edge.



OSHER Y-Hook

Straight.



OP0923-751

Overall length
4-1/2in (11.5cm).



CLAYMAN Micro Hook

0.3mm hook angled 45°.
Flat, smooth handle.



OP0923-102

Overall length
4-5/8in (11.7cm).



KNOLLE Micro Iris Hook

Blunt hook.
Round handle.
Matte and Mirror finish.



OP2103

Overall length
4-3/4in (12.1cm).



STEVENS Tenotomy Hook

Blunt tip.



OP2280

Overall length
4-3/4in (12.1cm).



Hooks

Crochets
Haken
Uncini
Ganchos
Ganchos
フック

JAMESON Muscle Hook

Small, bulbous tip with flat sides. Overall length 4-3/4in (12cm).



OP0924-601

Flat, serrated handle.



TYRELL Hooks

2mm wide. Overall length 4-3/4in (12.1cm).



OP2400

Sharp.

OP2401
Blunt.



NUGENT Iris Hook

Right-angled, sharp. Mirror and Satin finish.



OP2410

Overall length 4-3/4in (12.1cm).



SINSKEY Modified Hook

0.2mm hook. Curved shaft. Flat, serrated handle.



OP0923-301

Overall length 4-3/4in (12cm).



SHEETS Iris Hook

0.3mm curved hook. Round, knurled handle.



OP0923-001

Overall length 4-7/8in (12.5cm).



SHEPARD Iris Hook

Blunt hook.



OP2511

Overall length 4-7/8in (12.4cm).



JAFFE Iris Hook

Blunt hook.



OP2512

Overall length 5in (12.7cm).



Fixation Hooks

Two sharp prongs. Working length 1in (2.5cm). Overall length 5in (12.7cm).



◆ **OP2440**

Prongs 2mm wide.

OP2441

Prongs 1.5mm wide.

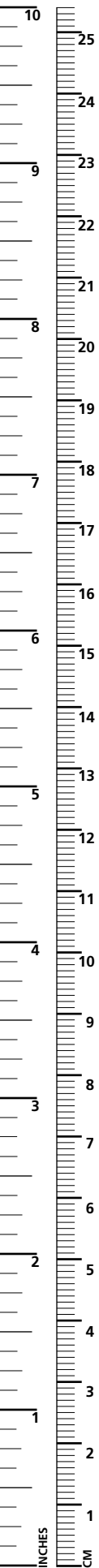

Crochets/Téléthèses
Haken/Manipulatoren
Uncini/Manipolatori
Ganchos/Manipuladores
Ganchos/Manipuladores
フック/マニピレーター

WIENER Hook

Sharp.
Mirror and Satin finish.



OP2420

Overall length
5in (12.7cm).



BONN Micro Iris Hook

Blunt hook. Flat handle.
Mirror and Satin finish.



OP2102

Overall length
5in (12.7cm).



O'CONNOR Sharp Hook



OP2321

Overall length
5-1/2in (14cm).



JAMESON Strabismus Hook



OP2310

Overall length
5-1/8in (13cm).



GREEN Strabismus Hook



OP2300

Overall length
5in (12.7cm).



VON GRAEFE Strabismus Hooks

Mirror and Satin finish.



OP2270

Small, 1.3cm.
Overall length
5-3/8in (13.7cm).

OP2271

Medium, 1.6cm.
Overall length
5-1/2in (14cm).

OP2272

Large, 1.7cm.
Overall length
5-5/8in (14.3cm).



GASS Retinal Detachment Hook

Tip 13mm. "GRAEFE-type" hook
with 1.5mm oval hole. Flattened
tip. Flat handle.

OP0924-701

Overall length
5-7/8in (15cm).



OSHER Nucleus Manipulator

0.5mm two-prong tip,
blunt, finger-like.
Round, knurled handle.



OP0923-501

Overall length
4-3/8in (11cm).



Hooks/Manipulators

Crochets/Téléthèses
Haken/Manipulatoren
Uncini/Manipolatori
Ganchos/Manipuladores
Ganchos/Manipuladores
フック/マニピレーター

SMITH Expressor Hook

11.5mm curved hook.
Flat, serrated handle.

OP0924-751

Overall length
5-3/4in (14.5cm).



RENTSCH Lens Manipulator

Straight with guard.

OP0923-701

Overall length
4-3/8in (11cm).



FENZL Micro Lens Insertion Hook

Angled 45°. Round handle.

OP2105

Overall length
4in (10.2cm).



HARRIS-SINSKEY Micro Lens Hook

Blunt hook. Angled 45°. Flat handle. Mirror and Satin finish.

OP2100-001

Overall length
4-1/2in (11.4cm).



KUGLEN Iris Hook and Lens Manipulator

Push-pull model. Round handle. Overall length 4-1/2in (11.5cm).

OP0923-601

Straight.



OP0923-602

Angled.



SINSKEY Lens Manipulating Hook

Tip diameter 0.25mm. Blunt tip. Round handle. Overall length 4-1/2in (11.5cm).

OP0923-302

Straight with guard.



OP0923-303

Angled.



Lens Manipulating Hook

Tip diameter 0.15mm. T-shaped tip. Overall length 4-1/2in (11.5cm).

OP0923-801

Straight.



SINSKEY II Lens Manipulating Hook

Tip diameter 0.2mm. Blunt tip. Round handle. Overall length 4-1/2in (11.5cm).

OP0923-304

Straight with guard.



OP0923-305

Angled.



Crochets/Téléthèses
Haken/Manipulatoren
Uncini/Manipolatori
Ganchos/Manipuladores
Ganchos/Manipuladores
フック/マニピレーター

SINSKEY Micro Lens Hook

Blunt hook. Angled 90°. Mirror and Satin finish.



OP2100

Overall length 4-5/8in (11.7cm).



SINSKEY II Micro Lens Hook

Blunt hook. Flat handle. Angled 90°. Mirror and Satin finish.



OP2100-002

Overall length 4-5/8in (11.7cm).



SMITH-LEISKE Lens Manipulator

Flat handle. Mirror and Satin finish.



OP2106

Overall length 4-1/2in (11.4cm).



MALTZMAN-FENZL Lens Manipulating Hook

Tip diameter 0.15mm. V-shaped tip. Overall length 4-3/4in (12cm).



OP0923-851

Angled. Round handle.



JAFFE-MALTZMAN Lens Manipulating Hook

Tip diameter 0.15mm. V-shaped tip. Overall length 4-3/4in (12cm).



OP0923-881

Angled.



CLAYMAN-JAFFE Lens Manipulating Hook

Angled. 0.2mm blunt hook.



OP0923-101

Overall length 4-3/4in (12cm).



HIRSCHMAN Iris Hook and Manipulator

Angled tip.

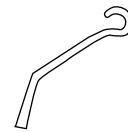

OP2502

Overall length 4-1/2in (11.4cm).



Hooks/Manipulators

Crochets/Téléthèses
 Haken/Manipulatoren
 Uncini/Manipolatori
 Ganchos/Manipuladores
 Ganchos/Manipuladores
 フック/マニピレーター

KUGLEN Iris Hook and Lens Manipulators

Push-pull model.
 Mirror and Satin finish.
 Overall length
 4-1/2in (11.4cm).



OP2504

Cloverleaf tip.



OP2504-002

Angled 45°.



OP2504-001

Straight.

CRAWFORD Retrieving Hook

OP0924-631



Titanium SINSKEY Hook

Tip diameter 0.18mm.
 Round, knurled handle.
 Overall length
 4-3/4in (12.1cm).



OP0916-601

Straight tip.



OP0916-602

Angled tip.

titanium



Titanium FENZL Hook



OP0916-701

Straight.

Overall length
 4-3/4in (12cm).



OP0916-702

Angled.
 Overall length
 4-5/8in (11.75cm).

titanium



Titanium KUGLEN Hook

9mm shaft with small
 "H"-shaped tip.
 Round, knurled handle.
 Overall length
 4-3/4in (12.1cm).



OP0916-801

Straight shaft.



OP0916-802

Angled shaft.

titanium



AKER Lens Pusher

Straight. "Fish Mouth"-
 shaped jaws.
 With guard.



OP0921-751

Overall length
 4-7/8in (12.5cm).



ROSEN Phaco Splitter

Blunt tip.
 Overall length
 4-3/8in (11cm).



OP0924-401

Wedge-shaped
 inferior edge.



OP0924-402

60° wedge-shaped
 inferior edge.



Téléthèses/Ciseaux
 Manipulatore/Scheren
 Manipolatori/Forbici
 Manipuladores/Tijeras
 Manipuladores/Tesoura
 マニピレーター/鉗

LESTER IOL Manipulators

For lenses without holes.



OP0921-601

Straight. With guard.
 Overall length
 4-3/4in (12cm).



OP0921-602

Curved.
 Overall length
 4-7/8in (12.5cm).



LESTER IOL Manipulator

Vaulted shank for lenses without holes.



OP0921-603

Overall length
 4-3/8in (11cm).



MALONEY IOL Manipulator

Vaulted shank for lenses without holes.
 With guard.



OP0921-701

Overall length
 4-1/2in (11.5cm).



HUNKELER IOL Manipulator Hook

For lenses without holes.
 Hemi ball tip diameter
 0.25mm. Round,
 knurled handle.



OP0923-201

Overall length
 4-3/4in (12cm).

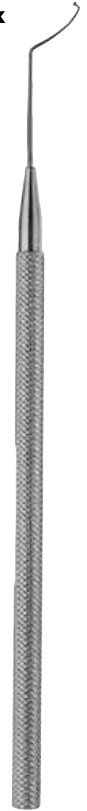

KOCH Stop and Chop Manipulator

Angled shaft with 1.5mm tip. Round, knurled handle.



OP0924-301

Overall length
 4-3/8in (11.2cm).



BARRAQUER Iris Scissors

Blunt blade with blunt tips.
 Flat, serrated, squeeze-action handle.
 Overall length 2-1/8in (5.5cm).

OP0907-601

Blades 7mm.

OP0907-602

Blades 10mm.



BARRAQUER-DeWECKER Iris Scissors

Delicate blades
 5mm from bend to tip.
 Mirror finish.

OP5510

Overall length
 2-1/8in (5.4cm).



Scissors

Ciseaux
Scheren
Forbici
Tijeras
Tesoura
鉋

DeWECKER Iris Scissors

Blades 11mm from bend to tip.
Overall length
4-3/8in (11.1cm).

OP5520
Sharp/Blunt.

OP5521
Sharp/Sharp.



McPHERSON-VANNAS Micro Iris Scissors

Curved blades,
19mm from mid-screw.
Sharp tips.

OP5583
Overall length
3in (7.5cm).



GILLS-WELSH VANNAS Micro Scissors

Blade length 10mm.
Angled. Sharp,
pointed tips.
Overall length
3-3/8in (8.6cm).

OP0907-051
Serrated handle.



Micro Iris Scissors

Blade 1cm from mid-screw.
Overall length
4in (10.2cm).

OP5598-001
Angled.

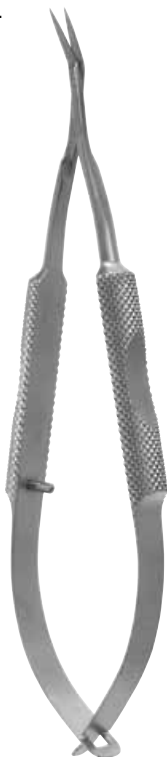

Iris Scissors

Straight.
22mm blades.



OP0907-702
Overall length
4-1/2in (11.5cm).



Micro Iris Scissors

Delicate. Sharp blades,
1cm from mid-screw.
Overall length
4-3/8in (11.1cm).

OP5501
Straight.

OP5502
Curved.



Micro Iris Scissors

Standard size blades.

OP5503

Overall length
4-1/2in (11.4cm).



McCLURE Iris Scissors

Angled. Mirror finish.

OP5500

Overall length
4-1/2in (11.4cm).



Iris Scissors

Curved-on-flat blades.

OP5505

Overall length
4-1/2in (11.4cm).



SHEPARD Iris Scissors

Serrated upper blade,
12mm from mid-screw.

OP2513

Overall length
4-1/2in (11.4cm).



Iris Scissors

Blades 2cm from mid-screw.
Mirror finish. Overall length
3-1/2in (8.9cm).

◆ **OP5000**

Straight.

OP5005

Curved.



Scissors

Ciseaux
Scheren
Forbici
Tijeras
Tesoura
鋏

Iris Scissors

Blades 18mm from mid-screw.
Sharp tips. Overall length
3-7/8in (10cm).

OP0907-703

Straight.

OP0907-704

Heavy, curved.



WILMER Iris Scissors

Angled. Mirror finish.

OP5560

Overall length
3-1/2in (8.9cm).



Iris Scissors

Ribbon-style handles.
Blades 3cm from mid-screw.
Overall length 4in (10.2cm).

OP5535

Straight.
Matte and Mirror finish.

OP5545

Heavy, curved.
Mirror and Satin finish.

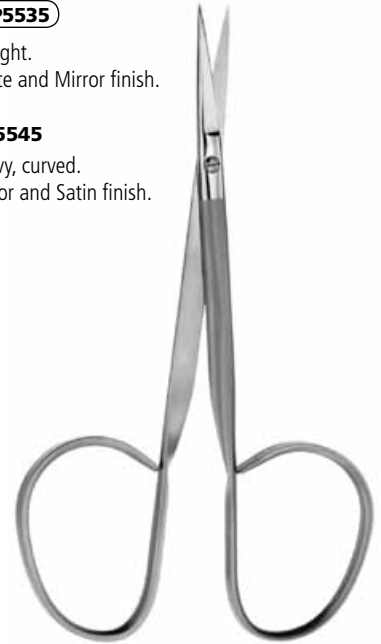

Iris Scissors

Angled. Mirror finish.

OP5570

Overall length
4-1/2in (11.4cm).



KNAPP Iris Scissors

Light pattern. Blades 3.5cm from mid-screw.
Mirror finish. Overall length 4in (10.2cm).

OP5550

Straight.

OP5551

Curved.



KNAPP Iris Scissors

Straight. Blades 3cm from mid-screw.
Mirror finish. Overall length
4in (10.2cm).

◆ **OP5530**

Sharp/Sharp.

OP5531

Sharp/Blunt.

OP5532

Blunt/Blunt.



KNAPP Iris Scissors

Curved. Blades 3cm from mid-screw.
Mirror finish. Overall length
4in (10cm).

◆ **OP5540**
Sharp/Sharp.

OP5541
Sharp/Blunt.

OP5542
Blunt/Blunt.

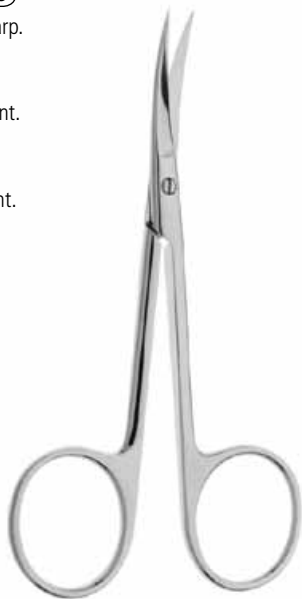

Super Cut Iris Scissors

Black handles. Overall length
4-1/2in (11.4cm).

OP5530-S
Straight.

◆ **OP5540-S**
Curved.



Vital® KNAPP Iris Scissors

Sharp/Sharp. Blades 2.8cm from mid-screw.
Stelliter cutting edges. Overall length
4-1/2in (11.4cm).

◆ **OP5525**
Curved.

◆ **OP5526**
Straight.



VANNAS Iridocapsulotomy Scissors

90° blades, 6mm from mid-screw.

OP5584
Overall length
3in (7.6cm).



GILLS-WELSH-VANNAS Capsulotomy Scissors

Angled blades,
5mm from mid-screw.
Mirror finish.

OP9303
Overall length
3in (7.6cm).



VANNAS Iridocapsulotomy Scissors

Small blades.
Mirror finish.
Overall length
3-3/8in (8.5cm).

OP5585
Straight.
Blades 8.5mm
from mid-screw.

OP5586
Curved.
Blades 8.5mm
from mid-screw.

OP5587
Angled.
Blades 6mm
from mid-screw.



Scissors

Ciseaux
Scheren
Forbici
Tijeras
Tesoura
鋏

GILLS-VANNAS Capsulotomy Scissors

Blade length 7mm with sharp tips. Overall length 3-3/8in (8.5cm). Thin long blades with sharp tips.

OP0907-101

Straight.

OP0907-102

Curved.

OP0907-103

Angled Forward.



VANNAS Scissors

Blade length 10mm. Sharp tips. Overall length 4-3/4in (12cm).

OP0907-501

Straight.

OP0907-502

Curved.



VANNAS Capsulotomy Scissors

Blade length 10mm. Wide handle. Overall length 4-3/4in (12cm).

OP0907-201

Small.

OP0907-202

Curved.



Iridocapsulotomy Scissors

Blades 8mm from mid-screw.

OP5597

Overall length 4in (10.2cm).



STERN-GILLS Scissors

Thin blades with sharp tips, length 10mm. Angled forward.

OP0907-251

Overall length 4-3/4in (12cm).



URIBE-STERN Scissors

Blade length 10mm. Curved. Angled forward.

OP0907-351

Overall length 4-3/4in (12cm).



CASTROVIEJO Graft Scissors

Tips angled-to-side.
Overall length
4in (10.2cm).

OP5564

Sharp tips.

OP5565

Blunt tips.



CASTROVIEJO Graft Scissors

Angled, blunt blades.
Lower blade length 16mm.
Upper blade length 15mm.
Serrated handle.
Mirror finish.

OP0917-801

Overall length
4-3/8in (11cm).



V. Mueller Instrument Warranty

We warranty every medical device and accessory bearing the V. Mueller brand name to be free of functional defects in workmanship and materials when used normally for its intended use. Any V. Mueller product proving to be so defective will be replaced or repaired at no charge. Repairs or modifications performed by unauthorized personnel may void all product warranties and could affect performance and efficacy of the device.

CASTROVIEJO Mini Graft Scissors

Curved blades, length
17mm from mid-screw.
Wide, serrated handle.
Mirror finish.

OP0917-802

Overall length
5-1/4in (13.3cm).



TORCHIA Conjunctival Scissors

Serrated upper blade,
11mm from mid-screw.

OP5667

Overall length
4in (10.2cm).



CASTROVIEJO Corneal Scissors

Angled. Blunt. Blade length
1.5cm from mid-screw.
Mirror finish.

OP5590

Overall length
3-1/2in (9cm).



Scissors

Ciseaux
Scheren
Forbici
Tijeras
Tesoura
鋏

TROUTMAN-CASTROVIEJO Corneal Section Scissors

With stop. Blades 8mm from mid-screw.
Overall length 4in (10.2cm).

OP5576

Left.



CASTROVIEJO Mini Corneal Section Scissors

Blade length 8mm. Curved.
Lower blade 0.5mm longer than upper blade. Blunt tips.
Overall length 4in (10.1cm).

OP0917-011

Right.

OP0917-012

Left.



CASTROVIEJO Micro Corneal Section Scissors

Blade length 9mm.
Curved right with blunt tips.
Lower blade 0.5mm longer than upper blade.
Serrated handle.
Mirror finish.

OP0917-001

Overall length 4in (10.1cm).



CASTROVIEJO Corneal Section Scissors

Curved blade 9mm from mid-screw. Lower blade 0.5mm longer.
Overall length 4in (10.2cm).

OP5588

Left.

OP5589

Right.



CASTROVIEJO Corneal Section Enlarging Scissors

Angled blades also curved, with one blunt tipped blade 0.5mm longer than the other.
Blade length 1.5cm from mid-screw. Mirror finish.
Overall length 4-3/8in (11.1cm).

OP5592

Right.

OP5593

Left.



CASTROVIEJO Micro Corneal Scissors

Curved.

OP5563

Overall length 4in (10.2cm).



CASTROVIEJO Micro Corneal Scissors

Blades 1cm from mid-screw. Curved.

OP5571-1

Overall length
4in (10.2cm).



CASTROVIEJO Mini Curved Corneal Scissors

Curved blade, length 11mm from mid-screw. Blunt tips. Flat, serrated handle. Overall length 4-1/8in (10.6cm).

OP0917-401

Right.

OP0917-402

Left.



CASTROVIEJO Medium Corneal Section Scissors

Blade length 10mm. Curved. Lower blade 0.5mm longer than upper blade. Blunt tips. Overall length 4in (10.1cm).

OP0917-021

Angled right.

OP0917-022

Angled left.



CASTROVIEJO Medium Corneal Section Scissors

Blade length 10mm. Curved. Lower blade 0.5mm longer than upper blade. Blunt tips. Overall length 4-3/4in (12cm).

OP0917-031

Angled right.

OP0917-032

Angled left.



CASTROVIEJO Corneal Scissors

Curved. Blunt. Blades 1.6cm from mid-screw. Mirror finish.

OP5600

Overall length
4-1/2in (11.4cm).



TROUTMAN-CASTROVIEJO Mini Corneal Section Scissors

Blade length 13mm. Curved. Blunt tips. Overall length 4-1/8in (10.5cm).

OP0917-201

Right.

OP0917-202

Left.



OPHTHALMIC

Scissors

Ciseaux
Scheren
Forbici
Tijeras
Tesoura
鋏

TROUTMAN-CASTROVIEJO Mini Corneal Section Scissors

Blade length 10mm.
Curved. Blunt tips.
Flat, serrated handle.
Overall length
4-5/8in (11.6cm).

OP0917-251

Right.

OP0917-252

Left.



BARRAQUER Corneal Section Scissors

With stop. Blade 8mm from
mid-screw. Overall length
4in (10.2cm).

OP5561

Right.



MANSON-AEBLI Corneal Section Scissors

Blade length 19mm. Upper
blade 1.5mm shorter than
lower blade. Overall length
4-1/2in (11.6cm).

OP0917-151

Right.

OP0917-152

Left.



AEBLI Corneal Section Scissors

Blade length 18mm from mid-screw.
Blunt tips. Overall length
4-3/4in (12cm).

OP0917-101

Right.

OP0917-102

Left.



McPHERSON-CASTROVIEJO Micro Corneal Scissors

Delicate curved blades,
12mm from mid-screw.
Overall length
3-1/2in (9cm).

OP5602

Right.

OP5603

Left.



KATZIN Micro Corneal Transplant Scissors

Curved blades, length 6mm.
Blunt tips. Overall length
4in (10.1cm).

OP0917-301

Right.

OP0917-302

Left.



KATZIN Mini Corneal Transplant Scissors

Curved, blunt tips.
Lower blade length 12mm.
Upper blade length 11mm.
Flat, serrated handle.
Overall length
4-1/4in (10.8cm).

OP0917-351

Right.

OP0917-352

Left.



AEBLI Corneal Scissors

Blades 22mm from mid-screw.
Mirror finish. Overall length
3-3/4in (9.5cm).

OP5620

Straight.

OP5621

Angled right.

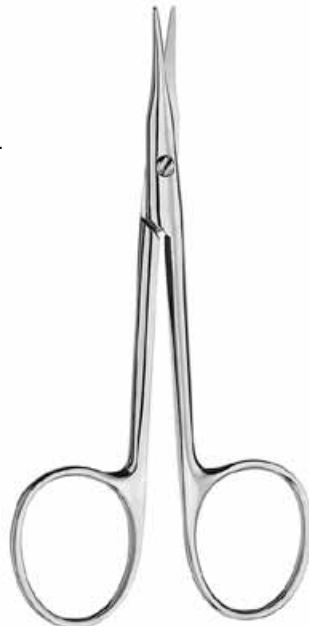

AEBLI Corneal Scissors

Blunt tips. Ring-handled.
Overall length
4in (10.1cm).

OP0917-451

Straight blades,
length 20mm
from mid-screw.

OP0917-452

Curved blades,
length 21mm
from mid-screw.



McGUIRE Corneal Scissors

Blades 20mm from mid-screw.
Overall length 4in (10.2cm).
Mirror finish.

OP5630

Right.



Ocular Scissors

Curved, sharp, double-beveled blades.
Mirror finish.

OP5795

Overall length
4in (10.1cm).



LA GRANGE Scissors

Highly curved blades, length 16mm.
Curved handles. Mirror finish.

OP5700

Overall length
4-1/2in (11.4cm).



Scissors

Ciseaux
Scheren
Forbici
Tijeras
Tesoura
鉋

KNAPP Strabismus Scissors

Blunt/Blunt. Blades 3cm from mid-screw. Mirror finish.
Overall length 4in (10.2cm).

OP5710

Slightly curved blades.

OP5720

Straight.



Vital® KNAPP Strabismus Scissors

Blunt/Blunt. Stellite® cutting edges.
Overall length 4-1/2in (11.4cm).

◆ **OP5740**

Curved.

◆ **OP5742**

Straight.



Strabismus Scissors

Round blades 3cm from mid-screw.
Ribbon-style handles.
Matte and mirror finish.
Overall length
4-1/4in (10.8cm).

OP5712

Curved.

OP5722

Straight.



Strabismus Scissors

Blades 30mm from mid-screw, with probe
points. Mirror finish.
Overall length
4in (10.2cm).

OP5730

Straight.

OP5730-001

Angled.

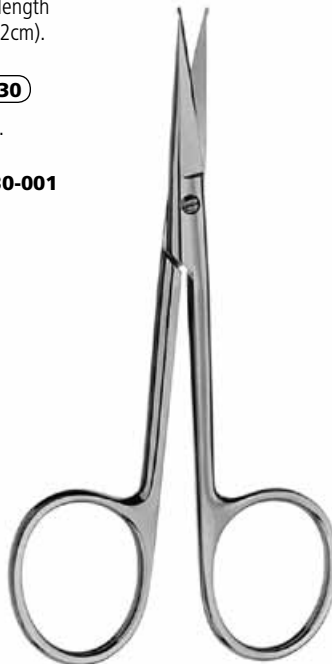

WESCOTT Tenotomy Scissors

Standard blades
12mm from the mid-screw.
Overall length
4-1/8in (10.5cm).

OP5671

Right.

OP5672

Left.



WESTCOTT Tenotomy Scissors

Slightly curved blades,
21mm from mid-screw.
Wide handle. Overall length
4-1/8in (10.5cm).

OP5669

Left.

OP5670

Right.



WESTCOTT Tenotomy Scissors

Blade length 16mm from
mid-screw. Blunt tips.
Wide, serrated handle.
Mirror finish. Overall length
5-1/4in (13.2cm).

OP0917-851

Curved tips.

OP0917-852

Straight tips.



WESTCOTT Tenotomy Scissors

Curved right. Blunt tips.
Mirror finish.

OP0917-853

Blades 23mm
from mid-screw.
Overall length
5-5/8in (14.2cm).

OP0917-854

Blades 21mm
from mid-screw.
Serrated upper blade.
Overall length
4-7/8in (12.3cm).



**McPHERSON Micro Tenotomy and
Conjunctival Scissors**

Curved. Blunt tips.
Blades 9mm from mid-screw.

OP5675

Overall length
3-1/4in (8.3cm).



STEVENS Tenotomy Scissors

Ribbon-style ring handle.
Curved blades,
18mm from mid-screw.
Mirror and Satin finish.

OP5692

Overall length
4in (10.2cm).



STEVENS Tenotomy Scissors

Blade length 19mm from mid-screw.
Straight blades with blunt tips.
Ring handles.

OP0917-899

Overall length
4in (10cm).



Scissors

Ciseaux
Scheren
Forbici
Tijeras
Tesoura
鋏

STEVENS Tenotomy Scissors

Blades 3.2cm from mid-screw.
Mirror finish.

OP5691

Curved, with short blades.
Overall length 3-1/2in (8.9cm).

OP5680

Straight.
Overall length 4in (10.2cm).

OP5690

Curved.
Overall length 4in (10.2cm).

OP5693

Curved.
Overall length 4-1/2in (11.4cm).

OP5694

Straight.
Overall length 4-1/2in (11.4cm).



Super Cut STEVENS Scissor

Overall length 4-1/2in (11.4cm).

OP5690-S

Curved.



Enucleation Scissors

Blades 40mm from mid-screw.
Mirror finish. Overall length 4-3/4in (12cm).

OP5760

Straight.

OP5761

Slightly curved.

OP5762

Fully curved.



McPHERSON Micro Utility or Suture Scissors

Sharp, pointed tenotomy-type tips.
Curved blades, 15mm from mid-screw.

OP5682

Overall length 3-3/4in (9.5cm).



HARRISON Suture-Removing Scissors

Blades 22mm from mid-screw. Mirror finish.

OP5781

Overall length 4-3/8in (11.1cm).



CASTROVIEJO Mini Graft Utility-Stitch Scissors

Blade length 13mm from mid-screw. Small, pointed tips. Wide, serrated handles.

OP0917-961

Overall length 5-1/8in (13.1cm).



WESTCOTT-Type Utility Scissors

Flat, serrated handles.
Blades 25mm from mid-screw.

OP5666

Overall length
5in (12.7cm).



Utility Scissors

Blade length 2.5cm from mid-screw. Curved.
Ribbon-style handles.
Matte and mirror finish.

OP5726

Overall length
4in (10.2cm).



JAFFE Stitch Scissors

Blade length 10mm from mid-screw. Medium tips.
Sharp, pointed tips.

OP0917-901

Overall length
4-3/4in (12cm).



WESTCOTT-Type Stitch Scissors

Very sharp pointed tips.
Blades 22mm from mid-screw.

OP5668

Overall length
4-3/8in (11.1cm).



WESTCOTT-Type Stitch Scissors

Blade length 21mm from mid-screw. Straight,
sharp, pointed tips.
Flat, serrated handles.

OP0917-931

Overall length
5-1/2in (14cm).



Fine Stitch Scissors

Blade length 16mm from mid-screw. Straight,
sharp, pointed tips.
Wide, serrated handles.

OP0917-992

Overall length
5-1/4in (13.2cm).



Scissors

Ciseaux
Scheren
Forbici
Tijeras
Tesoura
鋏

SPENCER Stitch Scissors

Mirror finish.

OP5780

Overall length
3-1/2in (8.9cm).



Stitch Scissors

Curved blades,
20mm from mid-screw.
Ribbon-style handles.
Mirror and Matte finish.

OP5793

Overall length
3-7/8in (9.8cm).



NUGENT-GRADLE Stitch Scissors

Short, slightly curved blades,
15mm from mid-screw.
Mirror finish.

OP5790

Overall length
4-1/8in (10.5cm).



Stitch Scissors

Curved, short blades. Mirror finish.

OP5792

Overall length
4-1/8in (10.5cm).



Eye Scissors

Blade length 29mm from mid-screw.
Round blade. Blunt tips.

OP0907-801

Overall length
4-1/8in (10.5cm).

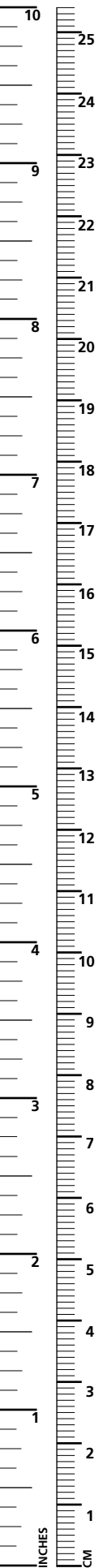

Porte-aiguilles
Nadelhalter
Porta-ago
Sostenes de agujas
Porta-agulhas
針ホルダー

COHAN Miniature Needle Holder

Curved, fine jaws, length 8mm. Round, knurled handle. Overall length 4in (10.2cm).



OP0908-801

With lock.

OP0908-802

Without lock.



McPHERSON Microsurgery Eye Needle Holders

Very delicate. Narrow jaws, length 12mm. Overall length 4-1/8in (10.5cm).



OP7471

Straight. With lock.

OP7471-001

Straight. Without lock.



OP7472

Curved. With lock.

OP7472-001

Curved. Without lock.



BARRAQUER Needle Holders

Delicate jaws, length 9mm. Short, round handle. Overall length 4-1/8in (10.4cm).



OP0908-201

Curved. With lock.

OP0908-202

Curved. Without lock.



OP0908-205

Straight. With lock.

OP0908-206

Straight. Without lock.



BARRAQUER Eye Needle Holders

Smooth jaws, length 10mm. Without lock. Overall length 4-5/8in (11.7cm).



OP7418-005

Straight.



BARRAQUER Needle Holder

Delicate, curved jaws.



OP0908-203

Round, knurled handle. With lock.

Jaw length 9mm.

Overall length 5-1/4in (13.2cm).



BARRAQUER Eye Needle Holders

Curved, smooth jaws, length 10mm. Overall length 5-1/4in (13.3cm).



OP7418

Delicate. With lock.



OP7418-001

With lock.

OP7418-002

Without lock.



Needle Holders

Porte-aiguilles
Nadelhalter
Porta-ago
Sostenes de agujas
Porta-agulhas
針ホルダー

BARRAQUER Eye Needle Holder

Curved, smooth jaws,
length 12mm.
Round handle, no lock.



OP7417

Overall length
5-1/4in (13.3cm).



BARRAQUER Needle Holders

Medium jaws, length 9mm.
Large, round, knurled handle.
Overall length
5-3/8in (13.5cm).



OP0908-401

Curved. With lock.

OP0908-402

Curved. Without lock.



OP0908-403

Straight. With lock.

OP0908-404

Straight. Without lock.



Titanium BARRAQUER Mini Needle Holders

Fine jaws, length 9mm.
Curved. Round, knurled
handle. Overall length
4-1/4in (10.8cm).



OP0915-201

With lock.

OP0915-202

Without lock.

titanium



Titanium BARRAQUER Needle Holders

Fine jaws, length 9mm.
Round, knurled handle.
Overall length
5in (12.7cm).



OP0915-001

Straight. With lock.

OP0915-002

Straight. Without lock.



OP0915-101

Curved. With lock.

OP0915-102

Curved. Without lock.

titanium



TROUTMAN-BARRAQUER Eye Needle Holder

Extra-delicate, smooth jaws,
length 10mm. Angled.
Without lock.



OP7418-003

Overall length
4-3/4in (12.1cm).



Micro Needle Holders

Delicate jaws, length 6mm.
Round handle.
Overall length
4-5/8in (11.8cm).



OP0908-901

Curved. With lock.

OP0908-902

Curved. Without lock.



OP0908-903

Straight. With lock.

OP0908-904

Straight. Without lock.



Porte-aiguilles
Nadelhalter
Porta-ago
Sostenes de agujas
Porta-agulhas
針ホルダー

Micro-Surgical Needle Holders

Delicate jaws, length 8mm.
Round handle.
Overall length
5-1/4in (13.3cm).



OP7430

Straight. Without lock.



OP7430-001

Curved. Without lock.

OP7430-002

Straight. With lock.

OP7430-003

Curved. With lock.



O'GAWA Needle Holders

Jaw length 9mm.
Round handle.
Mirror and Satin finish.
Overall length
5in (12.7cm).

OP7416-001

Curved.



CASTROVIEJO Eye Needle Holder

Curved jaws, length 10mm.
Round handle.



OP7414

Overall length
5in (12.7cm).



CASTROVIEJO Eye Needle Holders

Straight, smooth jaws, length 9mm.
Short shanks and wide handles.
Overall length
5-1/8in (13cm).



OP7412-004

With lock.

OP7412-005

Without lock.



CASTROVIEJO Eye Needle Holders

Moderately curved, smooth jaws,
length 9mm. Short shanks and
wide handles. Overall length
5-1/8in (13cm).



OP7413-004

With lock.

OP7413-005

Without lock.



CASTROVIEJO Needle Holder

Jaw length 10mm. Delicate jaws.
Straight. Overall length
5-1/2in (14cm).



OP0908-701

Without lock.



Needle Holders

Porte-aiguilles
Nadelhalter
Porta-ago
Sostenes de agujas
Porta-agulhas
針ホルダー

CASTROVIEJO Needle Holder

Curved jaws, length 10mm.
Flat, serrated handle.
Overall length
5-1/2in (14cm).



OP0908-702

With Lock.

OP0908-703

Without lock.



CASTROVIEJO Eye Needle Holders

Straight, smooth jaws, length 9mm.
Long shanks and wide handles.
Overall length
5-1/2in (14cm).



◆ **OP7412**

Delicate jaws.
Straight. With lock.



OP7412-002

With lock.

OP7412-003

Without lock.



CASTROVIEJO Needle Holder

Jaw length 12mm. Standard jaws.
Flat, serrated handle with lock.
Overall length
5-1/2in (14cm).



OP0908-704

Curved.



◆ **OP0908-705**

Straight.



CASTROVIEJO Needle Holder

16mm straight, heavy jaws.
Flat, serrated handle with lock.



OP0908-706

Overall length
5-3/4in (14.5cm).



CASTROVIEJO Eye Needle Holders

Curved, smooth jaws, length 9mm.
Long shanks and wide handles.
Overall length
5-1/2in (14cm).



OP7413-002

With lock.

OP7413-003

Without lock.



CASTROVIEJO-TROUTMAN Eye Needle Holders

Curved, smooth jaws,
length 9mm. Short shanks
and wide handles.
Overall length
5-1/8in (13cm).



OP7413-008

With lock.

OP7413-009

Without lock.



Porte-aiguilles
Nadelhalter
Porta-ago
Sostenes de agujas
Porta-agulhas
針ホルダー

Titanium CASTROVIEJO Needle Holders

Flat handle. Overall length
6-1/4in (15.9cm).



OP0915-501

10mm jaws.
Straight. With lock.

OP0915-502

12mm jaws.
Straight. Without Lock.



OP0915-503

12mm jaws.
Curved. With Lock.

OP0915-504

10mm jaws.
Curved. Without Lock.

titanium



Vital® CASTROVIEJO Needle Holders

Jaw length 9mm. With lock. Tungsten Carbide inserts.
3,600 teeth per square inch.
Overall length 5-1/2in (14cm).



OP7380

Curved.



◆ **OP7399**

Straight.



CASTROVIEJO-KALT Eye Needle Holder

Straight jaws, modified
KALT forceps,
incorporating
suture-cutting
blades in jaws.



OP7410

Overall length
5-1/2in (14cm).



KALT Eye Needle Holders

Straight, mild spring
action with thumb rest
and catch. Overall length
5-1/4in (13.3cm).

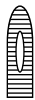

OP7400



OP7401

Very delicate,
fine-pointed
straight jaws.



Vital® KALT Eye Needle Holder

Straight. Tungsten
Carbide inserts.
3,600 teeth per
square inch.
Overall length
5-1/2in (14cm).



OP7398



Needle Holders

Porte-aiguilles
Nadelhalter
Porta-ago
Sostenes de agujas
Porta-agulhas
針ホルダー

ANIS Needle Holders

Jaw length 8mm.
Round, knurled handle.
Overall length
4-7/8in (12.5cm).



OP0908-001

Curved. With lock.

OP0908-002

Curved. Without lock.



OP0908-003

Straight. With lock.

OP0908-004

Straight. Without lock.



TENNANT Eye Needle Holders

Curved-on-flat.
Jaw length 12mm.
Overall length
5-1/4in (13.3cm).

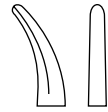

OP7415

Without lock.

OP7415-001

With lock.



GRIESHABER Eye Needle Holder

Straight jaws. Locks or releases
by simple finger pressure.



OP7419

Overall length
5-3/4in (14.6cm).



DERF Eye Needle Holder

Straight, serrated,
cupped jaws. Light.



OP7510

Overall length
4-3/4in (12.1cm).

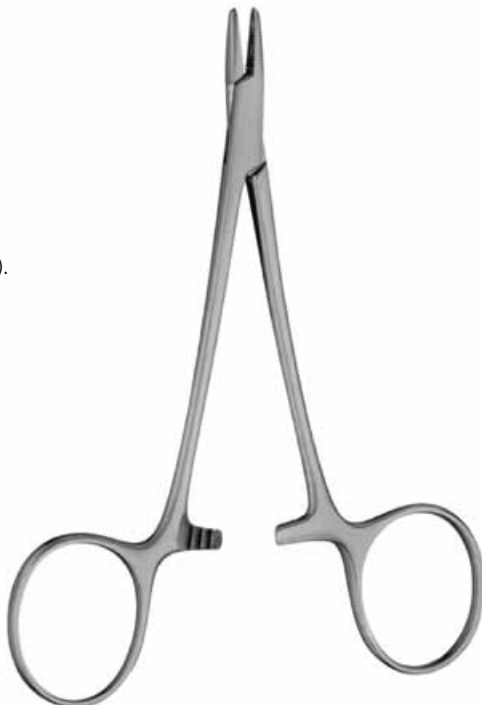

Vital® DERF Eye Needle Holder

Tungsten Carbide inserts.
3,600 teeth per square inch.



OP7512

Overall length
4-3/4in (12.1cm).



BISHOP-HARMAN Dressing Forceps

Cross-serrated tips, without teeth.



◆ **OP3413**
Overall length 3-3/8in (8.6cm).



Eye Dressing Forceps

Serrated.
Overall length 4in (10.2cm).



○ **OP3180**

Fine.

OP3181

Heavy.



Dressing Forceps

Serrated jaws.
Overall length 4in (10.2cm).



○ **OP3190**

Fully-curved.



OP8615

Straight.



KELMAN-MCPHERSON Forceps

Very delicate. Smooth.
Jaw length 7.5mm.
Angled. Flat, fenestrated handle.



○ **OP0911-801**

Overall length 4in (10.2cm).



Dressing Forceps

Fully curved, with serrations.
Overall length 4in (10.2cm).



○ **OP0911-401**

Heavy tips.

OP0911-402

Delicate tips.



LISTER Conjunctival Forceps

Fine teeth.
Overall length 3-5/8in (9.2cm).



○ **OP3150**

1 x 2 teeth.

OP3151

2 x 3 teeth.



THORPE Conjunctival Fixation Forceps

2 x 3 teeth.
Overall length 3-3/4in (9.5cm).



○ **OP3152**

Shallow 0.6mm teeth at 90°.

OP3153

Very delicate.
12mm teeth at 45°.



Forceps

Forceps
Zangen
Pinze
Fórceps
Fórceps
鉗子

ELSCHNIG-O'BRIEN Fixation Forceps

Plain. Delicate. 1 x 2 teeth.

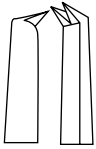

OP3110

Overall length
3-7/8in (9.8cm).



STEVENS Fixation Forceps

Plain. 1 x 2 teeth.



OP3140

Overall length
4in (10.2cm).



BRACKEN Fixation Forceps

Plain. 1 x 2 teeth.

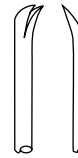

OP3090

Overall length
4in (10.2cm).



GREEN Fixation Forceps

T-shaped jaws, 5mm wide.



OP3070

Overall length
4in (10.2cm).



BORES U-Shaped Forceps



OP8921

Overall length
4-1/8in (10.5cm).



ELSCHNIG Fixation Forceps

Plain. 1 x 2 teeth.

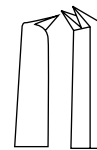

OP3100

Overall length
4-1/4in (10.8cm).



VON GRAEFE Fixation Forceps

Without lock. Jaws 5mm.

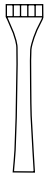

OP3000

Overall length
4-1/4in (10.8cm).



VON GRAEFE Eye Fixation Forceps

Standard pattern made of non-magnetic Alloy.

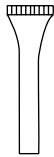

OP8600

Overall length
4-1/2in (11.4cm).



STERN-CASTROVIEJO Fixation Forceps

Tips 0.5mm, 1 x 2 teeth. Curved. Serrated handle with lock.



OP0911-001

Overall length
4-1/4in (10.8cm).



CASTROVIEJO Fixation Forceps

Tips 0.3mm, 1 x 2 teeth. Straight. Without platform. Wide, serrated handle.



OP0911-002

Overall length
4-1/4in (10.8cm).



GRAEFE Fixation Forceps

Jaw width 4.5mm. With fine, serrated teeth. Straight. Serrated handle with thumb lock.



OP0911-101

Overall length
4-1/4in (10.8cm).



BISHOP-HARMON Tissue Forceps

1 x 2 teeth. Curved shafts. Flat, fenestrated handle.



OP0911-301

Overall length
3-3/8in (8.5cm).



Forceps

Forceps
Zangen
Pinze
Fórceps
Fórceps
鉗子

Strabismus Tissue Forceps

Heavy 1 x 2 teeth.

OP3170

Overall length
3-7/8in (9.8cm).



Tissue Forceps

Slightly heavier than standard
Strabismus Forceps.
Straight, 1 x 2 teeth.

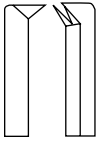

OP8610

Overall length
4in (10.2cm).



Cilia Forceps

Smooth, pointed jaws.



OP3210

Overall length
3-1/2in (8.9cm).



LITTAUER Cilia Forceps



OP3230

Overall length
3-1/2in (8.9cm).



GRADLE Cilia Forceps

Fine 2mm wide platform.
Cross-action, serrated
handle with tip guard.

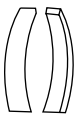

OP0913-301

Overall length
3-7/8in (9.7cm).



BARRAQUER Cilia and Suture Forceps

Tying platform 5mm.



OP3200

Overall length
4-1/8in (10.5cm).



SAUER Suture Forceps

1 x 2 teeth. Straight shaft with teeth set at oblique angle to shafts. Wide, serrated handle.

OP0910-701

Overall length 3-3/8in (8.6cm).



SAUER Suture Forceps

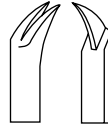

OP3325

Overall length 3-1/2in (8.9cm).



PAUFIQUE Suture Forceps

1 x 2 teeth. Straight. 6mm tying platform. Wide, serrated handle.



OP0910-801

Overall length 3-3/8in (8.7cm).



MCCULLOUGH Suture Forceps

1 x 2 teeth. Straight. Serrations behind teeth. Serrated handle.



OP0910-951

Overall length 3-5/8in (9.2cm).



MANHATTAN Suture Forceps

1 x 2 teeth. Straight shaft with teeth set at oblique angle to shafts. Wide, serrated handle.



OP0910-901

Overall length 3-3/8in (8.7cm).



BONN Suturing Forceps

Long. With tying platform. 0.12mm teeth.

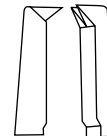

OP3505

Overall length 3-5/8in (9.2cm).



Forceps

Forceps
Zangen
Pinze
Fórceps
Fórceps
鉗子

CASTROVIEJO Suture Forceps

1 x 2 teeth.

OP0910-501

Tips 0.12mm teeth.
Standard handle.
Overall length
4in (10.1cm).



OP0910-502

Tips 0.9mm teeth.
Wide, serrated handle.
Overall length
4-1/4in (10.8cm).

STERN-CASTROVIEJO Suture Forceps

Tips 0.5mm teeth. 6mm tying platform. Straight. Wide, serrated handle with lock.



OP0910-601

Overall length
4-1/4in (10.8cm).



JAFFE-CASTROVIEJO Suture Forceps

1 x 2 teeth. Straight. 5mm tying platform. Overall length 4-1/4in (10.8cm).



OP0910-651

0.12mm teeth.

OP0910-652

0.3mm teeth.

OP0910-653

0.5mm teeth.



Titanium CASTROVIEJO Suture Forceps

1 x 2 teeth. 6mm tying platform. Short handle. Overall length 4-5/8in (11-7cm).

OP0916-501

.12 mm teeth.

OP0916-502

.3 mm teeth.

OP0916-503

.5 mm teeth.

titanium



CASTROVIEJO Corneoscleral Suture Forceps

1 x 2 teeth, 6mm tying platform. Overall length 4-1/8in (10.5cm).



OP3300

1.5mm teeth.

OP3301

Delicate 0.9mm teeth.

OP3302

Delicate 0.5mm teeth.

OP3303

Delicate 0.3mm teeth.



CASTROVIEJO Corneoscleral Suture Forceps

Angled jaws. Delicate 1 x 2 teeth. Overall length 4-1/8in (10.5cm).

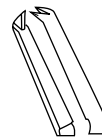

OP3305

1.5mm teeth.

OP3306

0.9mm teeth.

OP3307

0.5mm teeth.



McPHERSON Tying Forceps

Jaw length 5mm. Smooth. 4mm tying platform.
Flat, fenestrated handle. Overall length 4in (10.2cm).



OP0912-001

Straight.



OP0912-002

Curved.



SHEETS-MCPHERSON Tying Forceps

Tip width 1mm, serrated. Angled 45°. 10.5mm tying platform. Serrated handle.

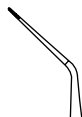

OP0912-101

Overall length
3-1/4in (8.2cm).



KELMAN-McPHERSON Micro Tying and Tissue Forceps

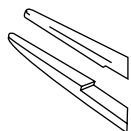

OP2509

Angled tips, 8mm.
Tying platform.
Overall length
3-1/2in (8.9cm).

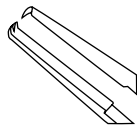

OP2509-001

Angled tips,
8mm. 1 x 2 fine teeth.
Tying platform.
Overall length
3-1/2in (8.9cm).

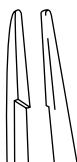

OP2509-002

Straight tips.
Overall length
3-5/8in (9.2cm).



LIEBERMAN Tying Forceps

6mm tying platform.



OP3493

Overall length
3-1/8in (7.9cm).



Forceps

Forceps
Zangen
Pinze
Fórcexs
Fórcexs
鉗子

HARMS Micro Tying Forceps

6mm tying platform.
Overall length
4in (10.2cm).



OP3310-001

Straight.



OP3310-002

Curved.



TENNANT Tying Forceps

6mm tying platform.
Matte and Satin finish.
Overall length
4in (10.2cm).



OP3426

Straight.



OP3426-001

Curved.



Titanium TENNET Tying Forceps

6.5mm tying platform.
Round, knurled handle.
Overall length
4in (10.2cm).



OP0916-201

Straight shafts.



OP0916-202

Curved shafts.

titanium



Titanium KELMAN-McPHERSON Tying Forceps

7mm tying platform.
Flat, serrated handle.
Overall length
3 3/8in (8.6cm).



OP0916-301

Straight shafts.



OP0916-302

Angled shafts.

titanium



Micro-Surgical Tying Forceps

5mm fine tips, cross-action.
Overall length
4-1/2in (11.4cm).

OP3330

Straight.



OP3330-001

Curved.



TROUTMAN Tying Forceps

Curved jaws, 10mm.



OP3462

Overall length
5-3/4in (14.6cm).



Forceps
Zangen
Pinze
Fórcps
Fórcps
鉗子

JAFFE Tying Forceps

Very delicate. Smooth jaws.
6mm tying platform.
Overall length
4in (10.2cm).



OP0912-201

Straight.



OP0912-202

Curved.



FUNTENNEY Tying Forceps

Heavy shaft. Straight.
7mm tying platform.
Wide, serrated handle.



OP0912-401

Overall length
4-1/8in (10.6cm).



Fine Tying Forceps

Curved shaft and tips.
Tying platform.
Wide, serrated handle.



OP0912-402

Overall length
4-1/4in (10.8cm).



Suture and Tying Forceps

Delicate, finely machined
tying platform, with heavy
shaft and handle.



OP3186

Overall length
4-1/8in (10.5cm).



O'GAWA Tying Forceps

1mm tip. 5mm tying platform.
Overall length
4-3/4in (12.1cm).



OP3428

Straight.

OP3428-001

Curved.



V. Mueller® Tying Forceps

7mm platform.
Overall length
4-3/8in (11.1cm).



OP3460

Straight.



OP3461

Angled.



Forceps

Forceps
Zangen
Pinze
Fórceps
Fórceps
鉗子

POLACK Double-Tipped Corneal Forceps

Tip length 0.3mm.
Separated 1mm with
0.2mm PIERSE tips.
Serrated handle.



OP0910-201

Overall length
2-3/4in (7.1cm).



BRACKEN-FARKAS Corneal Forceps

Tip length 0.12mm,
1 x 2 delicate teeth.
Straight, serrated handle
with stabilization pin.



OP0910-301

Overall length
4-1/4in (10.7cm).



GIRARD Corneal-Scleral Forceps

1 x 2 teeth. Round, knurled handle.
Overall length
4-1/4in (10.7cm).



OP0910-401

Tip length 0.12mm.
7mm tying platform.
Left-handed.

OP0910-402

Tip length 0.12mm.
6mm tying platform.
Right-handed.

OP0910-403

Tip length 0.3mm.
7mm tying platform.
Left-handed.

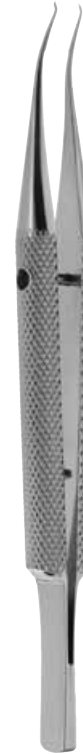

McPHERSON Micro Corneal Forceps

Very delicate, 1 x 2 teeth. Overall length 3-1/4in (8.3cm).

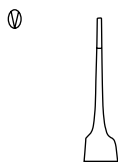

OP3491

Straight jaws.



McPHERSON-PIERSE Micro Corneal and Suture Forceps

Ultra-fine jaws, with PIERSE teeth, meet only at tips.
Overall length 3-3/8in (8.6cm).

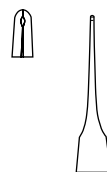

OP3497

Straight.



OP3498

Angled.



CASTROVIEJO Forceps

1 x 1 teeth. Straight.



OP3310

Overall length
3-5/8in (9.2cm).



CASTROVIEJO Corneal Suturing Forceps

Extra-delicate teeth, with tying platform. Straight wide handle. Overall length 4-1/8in (10.5cm).

◆ **OP3308-001**

0.12mm teeth.

◆ **OP3308-002**

0.3mm teeth.



◆ **OP3308-003**

0.5mm teeth.

OP3308-004

1.5mm teeth.

OP3308-005

0.12mm teeth. Angled jaws.



MAUMENEE Corneal Forceps

Tip length 0.12mm. 1 x 2 teeth. Angled 45°. 5mm tying platform. Serrated handle.



OP0910-251

Overall length
4-3/4in (12.1cm).



CASTROVIEJO-COLIBRI-Type Corneal Forceps

Tips 0.12mm.



OP3309-006

Overall length
4-1/8in (10.5cm).



HYDE-COLIBRI Corneal Forceps

Delicate tips 0.12mm, 2 x 2 teeth. 7mm tying platform. Angled 45°. Serrated, wide handle.



OP0910-103

Overall length
4-1/4in (10.7cm).



GILLS-COLIBRI Forceps

Very delicate tips. Flat, fenestrated handle.



OP0910-001

Overall length
3in (7.5cm).



Forceps

Forceps
Zangen
Pinze
Fórceps
Fórceps
鉗子

HARMS-COLIBRI Corneal Forceps

Delicate tips 0.12mm, 1 x 2 teeth.
4.5mm tying platform.
Angled 45°. Serrated, fenestrated handle.



OP0910-102

Overall length
2-3/4in (7cm).



COLIBRI Corneal Forceps

Angled 45°. 1 x 2 teeth.
Overall length
3in (7.6cm).

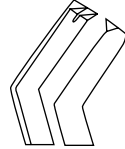

OP3309-001

Teeth 0.12mm.
With tying platform.

OP3309-002

Teeth 0.5mm.
With tying platform.

OP3309-003

Teeth 0.5mm.
Without tying platform.



PIERSE-COLIBRI-Type Corneal Forceps

Tips 0.12mm.

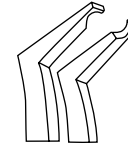

OP3309-004

Overall length
3in (7.6cm).



COLIBRI Forceps

Tips 0.12mm, 1 x 2 teeth.
Flat, fenestrated handle.



OP0910-101

Overall length
3in (7.5cm).



Titanium COLIBRI Forceps

Tips 0.12mm, 1 x 2 teeth.
6mm platform.
2mm angled tips.



OP0916-101

Overall length
3-3/8in (8.6cm).
Short, flat,
serrated handle.

OP0916-102

Overall length
4-1/2in (11.4cm).
Long, flat,
serrated handle.

titanium



SCHAAF Foreign Body Forceps

Fine-pointed, grooved jaws.
Smooth curve.
Finger grip handle.



OP0913-401

Overall length
4-1/8in (10.5cm).



SHAAF Foreign Body Forceps

Extra-fine grooved tips.
Finger grip.



OP1680

Overall length
3-3/4in (9.5cm).



WILSON Foreign Body Forceps

OP0913-451

Three, 2mm Prongs with
1mm Angled Tips. 20 Gauge.



NOBLE Iris Forceps

Straight. Very delicate,
1 x 2 teeth.

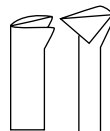

OP3400

Overall length
2-7/8in (7.3cm).



CHANDLER Iris Forceps

Curved. Smooth jaws.



OP3510

Overall length
2-7/8in (7.3cm).



VON GRAEFE Iris Forceps

1 x 2 teeth. Overall length 2-7/8in (7.3cm).

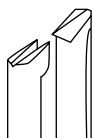

OP3405

Straight.

OP3406

Curved.



GILL Iris Forceps

Delicate. Gently curved. Without teeth.

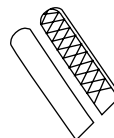

OP3424

Overall length
3in (7.6cm).



Forceps

Forceps
Zangen
Pinze
Fórceps
Fórceps
鉗子

BONN Model Peripheral Iridectomy Forceps

1 x 2 teeth.

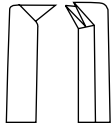

OP3515

Overall length
2-7/8in (7.3cm).



Titanium BONN Forceps

Tips 0.12mm, 1 x 2 teeth.
7mm tying platforms.

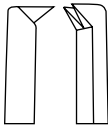

OP0916-401

Short, flat, serrated handle.
Overall length
3-3/8in (8.6cm).

OP0916-402

Long, flat, serrated handle.
Overall length
4-1/2in (11.4cm).

titanium



The IMPRESS instrument tracking systems are scalable solutions that help you manage and track inventory, and instrument flow processes throughout the continuum of instrument management.

Iris Forceps

Straight jaws, 1 x 2 teeth.
Overall length
3-7/8in (9.8cm).



OP3440

Light pattern.

OP3441

Heavy pattern.



Iris Forceps

1 x 2 mouse teeth. Delicate.
Lightly curved tips.
Serrated handle.



OP0911-501

Overall length
3-7/8in (9.9cm).



Iris Forceps

Curved. 1 x 2 teeth.



OP3450

Overall length
3-7/8in (9.8cm).



BISHOP-HARMAN Iris Forceps

Straight. 1 x 2 teeth.
Overall length
3-3/8in (8.6cm).

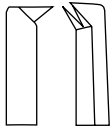

◆ **OP3410**

Standard.

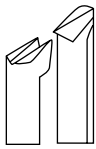

◆ **OP3412**

Delicate.



McPHERSON Micro Iris and Suture Forceps

Smooth tips.
Overall length
3-1/4in (8.3cm).



OP3495

Straight jaws.



OP3496

Angled jaws.



BRACKEN Iris Forceps

Delicate. Cross-serrated
curved tips. Serrated handle.



OP0911-601

Overall length
3-7/8in (9.8cm).



FOERSTER Iris Forceps

Curved. 1 x 2 teeth.



OP3490

Overall length
4in (10.2cm).



KRAFF Capsule Tag Forceps

Jaw length 10mm.
1.5mm smooth platform at tips.
Flat, fenestrated handle.



OP0911-901

Overall length
4in (10.2cm).



UTRATE Capsule Forceps

12mm angled shafts
with iris stop.
Fine angled tips.
Short handle.



OP0911-951

Overall length
3-1/8in (8cm).



Forceps

Forceps
Zangen
Pinze
Fórcexs
Fórcexs
鉗子

UTRATE Capsule Forceps

Very delicate grasping tips.
1mm long shanks.
Flat handle.

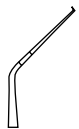

OP0911-952

Overall length
4in (10.2cm).



UTRATA Forceps

Very delicate grasping tips.
11mm long shanks with guide pin.
Round handle.



OP0911-953

Overall length
4-3/8in (11.2cm).



Titanium UTRATA Capsule Forceps

Jaw length 11mm.
Very delicate grasping tips.



OP0916-001

Short handle.
Overall length
3-1/4in (8.3cm).

OP0916-002

Long handle.
Overall length
4in (10.2cm).

titanium



Titanium UTRATA Capsule Forceps

Jaw length 11mm.
Very delicate grasping tips.

OP0916-003

Round handle.
Overall length
4-1/4in (10.8cm).

titanium



JAFFE Capsule Forceps

Very delicate.
Round grasping tips.
Thin shank, length 11mm.



OP0911-955

Overall length
4-1/4in (10.8cm).



LEHNER-UTRATA Capsule Forceps

Fine angled tips with
gently curved shaft.
Round handle.

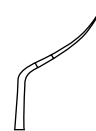

OP0911-991

Overall length
4in (10.2cm).



MASKET Capsule Forceps

Fine angled tips.
10mm angled shafts.
With iris stop.

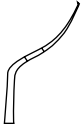

OP0911-992

Overall length
4in (10.2cm).



SCHWEIGGER Capsule Forceps

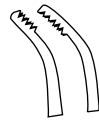

OP3620

Overall length
3-7/8in (9.8cm).



CASTROVIEJO Capsule Forceps

Cross-action, with
wide grip handle.
Cup jaw, 2mm x 3mm.



OP3731

Overall length
4-1/8in (10.5cm).



LAMBERT Chalazion Forceps

Solid lower plate, 1cm wide.

OP3800

Overall length
3-1/2in (8.9cm).



BAIRD Chalazion Forceps

Very delicate ring, inside
dimensions 8mm x 10mm.

OP3801

Overall length
3-3/4in (9.5cm).



GREEN Chalazion Forceps

Solid lower plate, 1.5cm wide.

OP3810

Overall length
3-3/4in (9.5cm).



Forceps

Forceps
Zangen
Pinze
Fórcexs
Fórcexs
鉗子

DESMARRES Chalazion Forceps

Oval solid lower plate, 2.5cm wide.

OP3850

Overall length
3-1/2in (8.9cm).



LAMBERT Chalazion Forceps

Large round, solid lower plate,
15 mm diameter.
Open upper plate,
12mm inside diameter.
Serrated handle with
thumb-locking screw.

OP0913-501

Overall length
3-7/8in (9.7cm).



Chalazion Forceps

16mm oval solid lower plate.
Open upper plate with inside
dimension of 12 x 14mm.
Cross-action serrated handle.

OP0913-601

Overall length
3-3/4in (9.6cm).



WIES Chalazion Forceps

Solid lower plate, open
serrated upper plate.
Outside width of solid
plate 15mm.

OP0913-651

Overall length
3-3/4in (9.4cm).



HEATH Chalazion Forceps

Overall length 4in (10.2cm).

OP3831

Small jaws.
12mm x 15mm.



TENNANT-TROUTMAN Superior Rectus Forceps

1 x 2 teeth. Curved shafts.



OP0911-701

Overall length
4-1/4in (10.75cm).



EHRHARDT Lid Forceps

Solid lower plate.
Straight serrated
upper jaw, 9mm wide.

OP3840

Overall length
3-1/2in (8.9cm).



BERKE Ptosis Forceps

Serrated, longitudinal.
Overall length
4-3/8in (11.1cm).

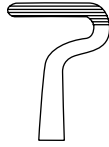

OP3895

Blades 20mm wide.

OP3896

Blades 27mm wide.



JAMESON Muscle Forceps

Jaw 2mm x 13mm.
Overall length
4in (10.2cm).

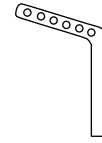

OP4030

Angled right.

OP4031

Angled left.



SHEETS Lens Forceps

Angled jaws are slim and
1cm in length.

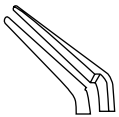

OP2525

Overall length
2-7/8in (7.3cm).



FAULKNER Lens Holding Forceps

Round, smooth jaws.



OP0912-601

Overall length
4-1/4in (10.8cm).



FAULKNER Lens Folding Forceps

Jaw length 12mm. Cross jaws.



OP0912-602

Overall length
4in (10.2cm).



Forceps

Forceps
Zangen
Pinze
Fórcexs
Fórcexs
鉗子

LIVERNOIS Soft IOL Holding Forceps

7mm conical jaw. Angled.



OP0912-701

Overall length
4-1/4in (10.8cm).



SIMCOE Lens Forceps



OP25001

Overall length
4-3/4in (12.1cm).



THORNTON Intraocular Lens Forceps

Jaw length 11mm.
Smooth. Angled 45°.
Flat handle.



OP0912-501

Overall length
3-3/8in (8.6cm).



BLAYDES Lens Holding Forceps

Very delicate. Blades angled 45°.
Narrow, smooth jaws.
Without lock.

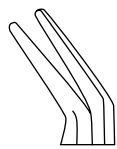

OP25004

Overall length
4-3/8in (11.1cm).



KRATZ Lens Forceps

Curved, smooth jaws.
Without lock.



OP25003

Overall length
4-5/8in (11.7cm).



SHEPARD I Lens Forceps

17mm jaws open to 5mm.
Overall length
5-1/8in (13cm).



OP2510-001

With "Nudge Notch"
and lock.



Titanium FINE Folding Forceps

Jaw length 7mm. Angled shanks.
Overall length
4-1/4in (10.8cm).



OP0915-901

Delicate PIERSE tips.
FINE II type.

OP0915-902

FINE III style.

titanium



Jeweler-Type Forceps

Extra-fine pointed tips.
Straight shafts.
7mm tying platform.
Smooth handle.



OP0913-201

Overall length
4-3/4in (12cm).



BONACCOLTO Jeweler-Type Forceps

Wide handle.



OP3187

Overall length
4-1/4in (10.8cm).



BONACCOLTO Jeweler-Type Forceps



OP3188

Overall length
4-1/8in (10.5cm).



McCULLOUGH Utility Forceps

Straight. 12mm cross-serrated jaws.
Serrated handle.



OP0913-791

Overall length
3-5/8in (9.3cm).



ALABAMA UNIVERSITY Utility Forceps

Jaws have deep longitudinal groove and fitted platform.



OP3184

Overall length
3-5/8in (9.2cm).



Forceps

Forceps
Zangen
Pinze
Fórcexs
Fórcexs
鉗子

SANDT Utility and Suture Forceps



OP3189

Overall length
3-3/4in (9.5cm).



BONACCOLTO Utility and Pick-up Forceps

Tips have fine cross-serrations.
Small, 1.2mm wide at tips.

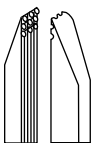

OP3183

Overall length
3-7/8in (9.8cm).



McCULLOUGH Utility Forceps

Smooth jaws.



OP3182-001

Overall length
4in (10.2cm).



AZAR Utility Forceps

Tips serrated 3mm from end.
Overall length
4in (10.2cm).



OP3295

Straight.



OP3295-001

Curved.



BONACCOLTO Utility Forceps

Straight 1.7mm wide,
17mm large platform.
Serrated jaws.
Cross-serrated tips.
Cross-serrated handle.

OP0913-751

Overall length
4-1/4in (10.9cm).



WILLS Utility Forceps

Straight 15mm serrated
platform jaws.
Serrated handle.

OP0913-721

Overall length
4-1/4in (10.9cm).



GASKIN Fragment Forceps

10mm smooth jaws. Very delicate.
Angled. Flat, fenestrated handle.



OP0911-851

Overall length
4-1/4in (10.8cm).



ROLF Utility Forceps

Fine, delicately pointed jaws.



OP3291

Overall length
4-1/4in (10.8cm).



NUGENT Utility Forceps

10mm smooth jaws. Angled 45°. Serrated handle.

OP0913-701

Overall length
4-1/4in (10.7cm).



LIVERNOIS Pickup and Holding Forceps

Jaw length 7mm.
Concave jaw surface.



OP0912-901

Overall length
4-1/4in (10.8cm).



Fine II Universal Forceps

Jaw length 7mm. Angled.
Overall length
4-1/2in (11.4cm).



OP0913-001

With Lock.

OP0913-002
Without Lock.



Scleral Plug Forceps

Jaw length 10mm. Cross-action.
Serrated handle.



OP0913-901

Overall length
4-1/8in (10.4cm).



Forceps/Spreaders/Blades

Forceps/Râteaux/Lames
 Zangen/Spreizer/Klingen
 Pinze/Divaricatori/Lame
 Fórceps/Espátulas/Cuchillas
 Fórceps/Afastadores/Lâminas
 鉗子/スプレッター/ブレード

WATZKE Sleeve Spreading Forceps

Jaw length 15mm. 10mm tips, serrated. Angled 30°. Serrated cross-action handle.

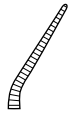

OP0913-801

Overall length 5-5/8in (14.4cm).



LAMBERT Sleeve Spreader

Jaw length 10mm. Smooth 90° jaws. With locking screw.



OP0913-851

Overall length 4-1/8in (10.6cm).



Looking for a specific product?

When you know the catalog number or the name of the product you need, you can use the index at the end of this book to direct you to the page on which the product is described. If you do not find the specific instruments you are looking for, please contact your local V. Mueller sales representative or Customer Support at **800.323.9088**.

McNEIL-GOLDMAN Scleral Blades

OP0906-901

17mm inner diameter. 24mm outer diameter.

OP0906-902

14mm inner diameter. 23mm outer diameter.

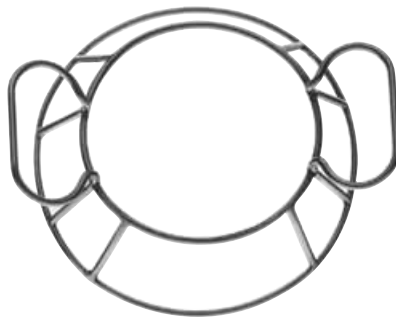

Trephine Blades

Disposable.

Short	Long	Size
OP0918-001	OP0918-101	6.0mm
OP0918-002	OP0918-102	6.5mm
OP0918-003	OP0918-103	6.75mm
OP0918-004	OP0918-104	7.0mm
OP0918-005	OP0918-105	7.25mm
OP0918-006	OP0918-106	7.5mm
OP0918-007	OP0918-107	7.75mm
OP0918-008	OP0918-108	8.0mm
OP0918-009	OP0918-109	8.25mm
OP0918-010	OP0918-110	8.5mm
OP0918-011	OP0918-111	9.0mm
OP0918-012	OP0918-112	9.5mm



Short



Long

KELLY Decemet Membrane Punch

1mm diameter tip with guard.
 Overall length
 5-1/8in (13cm).

OP0919-301

Serrated squeeze handle.



GASS Corneoscleral Punch

1mm diameter tip. Rotatable.
 Mirror finish.

OP0919-351

Overall length
 3-1/2in (9cm).



LUNTZ-DODICK Trabeculectomy Punch

1mm diameter rotatable cutting head.
 Bullet-shaped tip. 0.5mm bite.
 Mirror finish.

OP0919-381

Overall length
 4-3/4in (12cm).



DODIC Nucleus Splitter

Serrated, paddle-shaped jaws.



OP0912-801

Overall length
 4-1/4in (10.8cm).



Retractors/Spoons

Écarteurs/Cuillers
Wundspreizer/Retraktoren/Löffel
Divaricatori/Cucchiai
Separadores/Cucharas
Retradores/Colheres
リトラクター/スプーン

Titanium SALZ Nucleus Splitter



OP0916-921

Overall length
3in (7.5cm).

titanium



Orbital Retractors

Overall Length
7-1/4in (18.2cm).

OP0906-320

Blades
16mm deep x 25mm long.

OP0906-321

Blades
10mm deep x 14mm long.



SCHEPENS Orbital Retractor

Overall length
5-7/8in (15cm).

OP0906-201

Forked.



BUNGE Exenteration Spoon

Small diameter, 8mm.

OP2600

Overall length
5-1/8in (13cm).



FOSTER Enucleator Snare

Snare Wires.
Overall length
6-1/8in (15.5cm).
Comes with one
package of (12),
OP0922-111 Snare Wires.

OP0922-101

OP0922-111

Snare wires.
Wire length 135mm.
12 per package.



WELLS Enucleation Spoon

21mm diameter.
Mirror and Satin finish.

OP2610

Overall length
5-3/4in (14.6cm).



Air Injection Cannulas

Blunt. Mirror finish.
Working length 2cm.

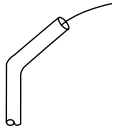

OP2065

27GA.

OP2066

30GA.



RAINEN Air Injection Cannulas

Spatula tip angled 7mm
from tip to bend.
Mirror finish.



OP0902-501

30GA.

OP0902-502

27GA.



Air Injection Cannulas

Angled 7mm from tip to bend.
Mirror finish.



OP0905-301

30GA.

OP0905-302

27GA.



HEALON Injection Cannula

Angled shaft with flat tip.
Mirror finish.



OP0902-551

21GA.



GILLS-WELSH Cannulas

Angled. Smooth blunt tip. 25GA.
Mirror finish.

OP0902-804

Shaft angled 5mm from tip to bend.

OP0902-805

Shaft angled 7mm from tip to bend.



OP0902-806

Shaft angled 8mm
from tip to bend.

OP0902-807

Shaft angled 10mm
from tip to bend.



GIMBEL Cannulas

Forward-irrigating cannula.
Mirror finish.



OP0904-601

28mm shaft. 30GA.

OP0904-602

17mm shaft. 26GA.



SIMCOE Irrigating Spatula

Notched. Nickel and Chrome Plated.



OP25011

25GA.



CARTER Irrigating Cannula

Shaft curved 10mm from tip to bend.
Flattened tip 25GA.



OP0903-601

Mirror finish.



**WILBRANDT-BINKHORST
Irrigating Cannulas**

23GA. Smooth, blunt tip with
front opening. Mirror finish.



OP0904-501

Straight shaft.



OP0904-502

Left.

OP0904-503

Right.



Cannulas/Spatulas

Canules/Spatules
 Kanülen/Spatel
 Cannule/Spatole
 Cánulas/Espátulas
 Cânulas/Espátulas
 カニューレ/ヘラ

GILLS-WELSCH Olive Tip Irrigating Cannula

1mm, smooth, bulbous tip.
 Angled 45°. Mirror finish.



OP0904-805

25GA.



KNOLLE-PEARCE Irrigating Cannula

Three irrigating holes.
 Mirror finish.



OP2079

23GA loop.



Irrigating Spatula

24GA. Mirror finish.

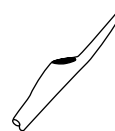

OP2063

Working length 1/2in (1.3cm).
 Overall length 1-5/8in (4.1cm).



McINTYRE Anterior Chamber Irrigating Cannulas

Smooth blunt tip. Mirror finish.



OP0902-601
 Straight. 23GA.

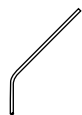

OP0902-602
 Angled. 23GA.

OP0902-603
 Straight. 26GA.

OP0902-604

Angled. 26GA.

OP0902-605
 Straight. 30GA.

OP0902-606
 Angled. 30GA.



KNOLLE Anterior Chamber Irrigating/Aspirating Cannula

Mirror Finish.



OP0902-611

25GA.



BRACKEN Anterior Chamber Cannula

Angled shaft.
 Beveled tip with front opening.
 Mirror finish.



OP0902-621

19GA.



SCHEIE Anterior Chamber Cannula

Straight with blunt tip.
 Mirror finish.



OP0902-631

27GA.



McINTYRE Inner Cannulas

23GA. Straight shaft. Mirror finish.



OP0903-651

Side port.



OP0903-652

Front port.



Anterior Chamber Irrigators

Mirror finish.

OP2519

30GA.



BISHOP-HARMAN Anterior Chamber Irrigating Cannula

Silver tubing,
Silver-Plated Brass hub.
Mirror finish.



OP6790

Overall length
1-5/8in (4cm).



BISHOP-HARMAN Anterior Chamber Irrigating Cannula

Luer lock hub. Fits standard 2cc syringe.
Silver tubing, silver plated brass hub.
Mirror finish.

OP6791

Overall length
1-3/4in (4.4cm).



BISHOP-HARMON Anterior Chamber Irrigators



OP0902-701

Complete Set.

OP0902-703

Cannula only. 19GA.

OP0902-704

Silicone bulb only.

OP0905-401

Irrigator only. 21GA.



SHEETS Irrigation Cannula

Serrated loop.
Three large front
openings. Mirror finish.

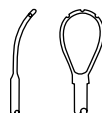

OP0903-351

21GA.



SIMCOE Irrigation Lens Loops

25GA. Finely serrated tip with two front ports.
Mirror finish.

OP0904-711

Shaft curved right.

OP0904-712

Shaft curved left.



KNOLLE Anterior Chamber Irrigating Cannulas

Angled tip, 2mm.
Mirror finish.

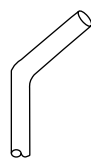

OP2078

23GA.

OP2078-001

30GA.



Cortex Aspirating Cannulas

Angled. Mirror finish.

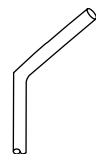

OP2518

25GA.

OP2518-001

23GA.



Looking for a specific product?

When you know the catalog number or the name of the product you need, you can use the index at the end of this book to direct you to the page on which the product is described. If you do not find the specific instruments you are looking for, please contact your local V. Mueller sales representative or Customer Support at **800.323.9088**.

Cannulas

Canules
Kanülen
Cannule
Cánulas
Cânulas
カニューレ

MAUMENEE Aspirating Needle



OP0902-591

18GA.



SALZ Aspirating Cannula

Length 15mm. Straight. Mirror finish.



OP0904-772

23GA.



MORRISON Aspirating Cannula

Shaft angled 7mm from tip to bend. Smooth blunt tip. Mirror finish.



OP0904-511

23GA.



GIMBEL Cortex Aspirating Cannula

Angled shaft. Front port. Mirror finish.



OP0904-621

30GA.



ANIS Cortex Aspirating Cannulas

Tip 0.4mm. Side port. 23GA. Mirror finish.



OP0904-552

Angled tip.



SIMCOE Cortex Extractor

21mm smooth closed tip with side opening. Mirror finish.



OP0902-901

23GA.



SIMCOE Cortex Extractor

Curved. Mirror finish.



OP25201

23GA.



WELSH Cortex Extractors

Flat, olive tip. 25GA. Mirror finish.



OP0903-551

Shaft curved right.

OP0903-552

Shaft curved left.



GILLS-WELSH Cortex Extractors

Flat, olive tip. 25GA. Mirror finish.



OP9300-001

Left.

OP9300-002

Right.



Curettes/Crochets
Küretten/Haken
Curette/Uncini
Curetas/Ganchos
Curetas/Ganchos
キュレット/フック

OSHER Irrigating Implant Hook

30GA bi-angled working end.
24GA reinforced shaft.
Mirror finish.



OP0905-001

Canulla overall length 23mm.



BECHERT Capsule Polisher

For polishing posterior capsule.
Olive tip. Mirror finish.



OP2064

25GA.



KNOLLE Capsule Polishers

Angled tip, 2mm. Mirror finish.

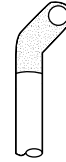

OP2067

23GA.

OP2067-001

30GA.



JENSEN Capsule Polishers

Carbide tip. Mirror finish.

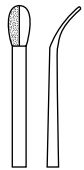

OP2071

23GA.

OP2071-001

25GA.



JENSEN Capsule Scraper Polishers

Gently curved with olive tip.
Front opening. Mirror finish.



OP0902-111

27GA.

OP0902-112

23GA.

OP0902-113

25GA.



DREWS Capsule Polisher

With inside port. Angled ring.
Mirror finish.



OP0902-201

25GA.



KRAFFE Posterior Capsule Polisher

Cup size 1.75mm. Semi-sharp edge.
Irrigating port. Mirror finish.



OP0902-251

25GA.



Capsule Polishing Curette

Beveled semi-sharp edge.
Mirror finish.



OP0902-301

25GA.



FREEMAN Posterior Capsule Polisher

With three holes.



OP0902-151

19GA.



Retractors/Cannulas/Spatulas

Écarteurs/Canules/Spatules
Wundspreizer/Retraktoren/Kanülen/Spatel
Divaricatori/Cannule/Spatole
Separadores/Cánulas/Espátulas
Retradores/Cânulas/Espátulas
リトラクター/カニューレ/ヘラ

SIMCOE Posterior Capsule Scrubbers

Reverse aperture.
Mirror finish.

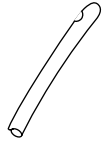

OP20641-01

23GA.



KRATZ Angled Capsule Scraper

1mm tip. Lightly angled shaft
with front opening.



OP0902-001

22GA.



SALZ Irrigating Capsule Retractor

Straight.
Mirror finish.



OP0904-771

20GA.



KRATZ Cannula

Carbide tip. Mirror finish.

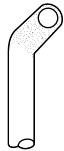

OP2059

22GA.



SIMCOE Nucleus Erisophake

Mirror finish.

OP65601



SHEETS Cyclodialysis Cannula

Spatula tip with front and two side ports.
Mirror finish.



OP0901-201

19GA.



KELMAN Cyclodialysis Cannulas

19GA. Mirror finish.



OP0901-212

Spatula tip with left port.



SIMCOE Nucleus Spatula

Mirror finish.

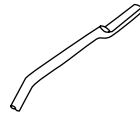

OP20621

25GA.



THURMOND Nucleus Irrigation Cannula

Tip curved up, smoothed
downward with front opening.
Mirror finish.



OP0901-921

19GA.



RANDOLPH Cyclodialysis Cannula

Opening at front of tip for air injection.
Tip 1cm. Luer lock hub, one size.
Mirror finish.

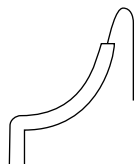

OP2070

18GA.



RANDOLPH Cyclodialysis Front Cannulas



OP0901-251

Curved spatula tip.

OP0901-252

With delicate blade.



TROUTMAN Alpha-Chymotrysin Cannula

Delicate tip.



OP6601

25GA.



Lacrimal Cannula

Straight shaft with blunt tip.
Mirror finish.



OP0903-151

25mm tip. 23GA.



McINTYRE Lacrimal Cannula Probes

Dual 0.3mm side ports. 23GA.
Mirror finish.



OP0903-001

Straight.



OP0903-002

Curved.



BAILEY Lacrimal Cannula

Reinforced shaft with blunt 6mm tip.
Mirror finish.



OP0903-101

23GA.



Lacrimal Cannulas

23GA. Reinforced. Malleable tip.
Mirror finish.



OP0903-152

Straight.



OP0903-153

Curved.



Lacrimal Cannula

Bulbous Silver tip. Luer lock hub.
Mirror finish.



OP6920

Working length
3/4in (1.9cm).



Due to changing surgical trends, some products described in this catalog may be discontinued. Your V. Mueller sales representative may be able to suggest a suitable substitute if one is available.

Cannulas

Canules
Kanülen
Cannule
Cánulas
Cânulas
カニューレ

SHANINIAN Lacrimal Cannula

Blunt tapered tip with side port.
Mirror finish.



OP0903-401

23GA.



TULEVECH Lacrimal Cannula

Angled shaft with reinforced tip.
Mirror finish.

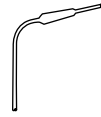

OP0903-411

23GA.



WEST Lacrimal Cannula

Blunt tip with side openings.
30mm tip length.
Mirror finish.



OP0903-171

23GA.



STEVENS Sub-Tenons Anesthesia Cannula

Gently curved shaft with flattened tip.
Mirror finish.



OP0901-051

19GA.



CORBIN Sub-Tenons Anesthesia Cannula

Smooth, rounded tip.
Mirror finish.



OP0901-101

23GA.



GROSS Sub-Tenons Anesthesia Cannula

Flattened, gently curved shaft with burnished tip.
Mirror finish.



OP0901-111

21GA.



ATKINSON Retrobulbar Cannula

Working length 1-3/8in (3.5cm).



OP0903-201

25GA.



ATKINSON Retrobulbar Cannula

Sharp, rounded point.
Working length 2-1/8in (5.4cm).

OP1934

23GA.



SEELY Hydrodissection Cannula

Angled, flattened tip.
Mirror finish.



OP0901-401

26GA.



SEELY Hydrodissection Cannula

Flattened tip. Angled.
12mm from tip to bend.
Mirror finish.



OP0901-811

26GA.



GIMBEL Hydrodissection Cannula

Smooth, blunt tip with front opening.
Mirror finish.



OP0904-611

30GA.



HESLIN Infusion Cannulas

Beveled tip length 3mm. Mirror finish.



OP0905-101

23GA.

OP0905-102

25GA.

Infusion Handles

Mirror finish.

OP0905-151

Length 4-7/8in (12.5cm).

OP0905-152

Length 3in (7.5cm).



NICHAMIN Hydrodissection Cannulas

Curved shaft with flattened tip.
Mirror finish.

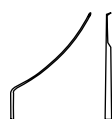

OP0905-201

25GA.

OP0905-202

27GA.



BECHERT Intraocular Lens Cannulas

For positioning intraocular lens.
27GA. Mirror finish.



OP2517

Horizontal notch.



Cannulas

Canules
Kanülen
Cannule
Cánulas
Cânulas
カニューレ

KRATZ Lens Manipulation Cannula

Tip 0.2mm. 30GA.
Mirror finish.



OP0901-911

With flushing port.



OSHER Cannulas

J-shaped tip.
Mirror finish.



OP0903-451
27GA.

OP0903-452

25GA.



YOUENS Lens Manipulation Cannula

Tip 0.3mm. 30GA.
Mirror finish.



OP0901-941

With flushing port.



DREWS-KNOLLE Lens Loop Cannula

One front and two backward opening ports.
Mirror finish.

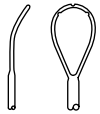

OP0903-301

23GA.



PASANELLA-Style Cannula

22mm curved, reinforced shaft with blunt tip.
Mirror finish.



OP0903-501

23GA.



BINKHORST Irrigating/Aspirating Cannulas

22GA. Smooth, blunt tip with front opening.
Mirror finish.



OP0904-651

Straight shaft.



OP0904-652

Shaft angled left.

OP0904-653

Shaft angled right.



McINTYRE-BINKHORST Irrigating/Aspirating Cannulas

26GA. Smooth, blunt tip with front opening. Mirror finish.



OP0904-701

Straight tip.



OP0904-702

Tip curved right.

OP0904-703

Tip curved left.



GILLS Irrigating/Aspirating Cannula

Angled 30°.
23GA irrigation tube.
25GA aspiration tube.



OP0904-801

Mirror finish.



SIMCOE Reverse Irrigating/Aspirating Cannula

15mm curved tubing. Slightly longer irrigating tip. Mirror finish.



OP0904-001
23GA.

SWISS Double-Barrel Irrigating/Aspirating Cannula

Shaft angled 45° with 0.3mm front opening. Mirror finish.

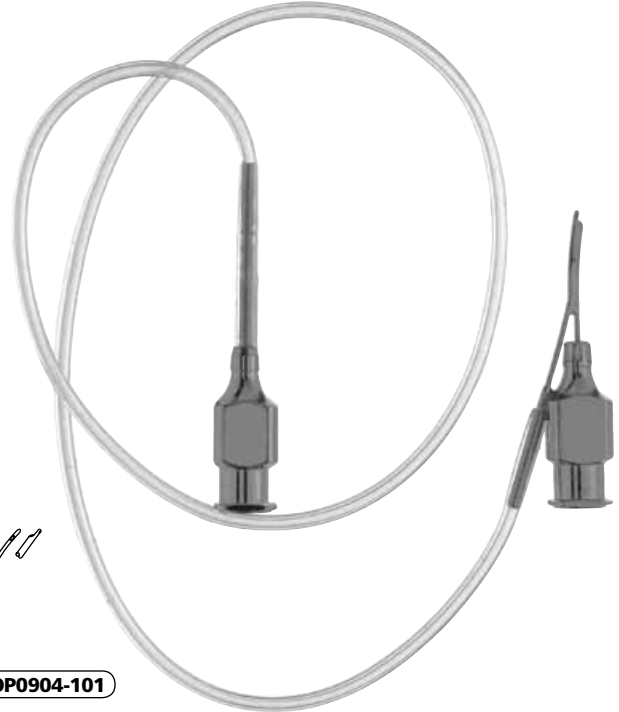

OP0904-101
23GA.

GRANDON Irrigating/Aspirating Cannulas

0.3mm side port. Mirror finish.



OP0904-153
25GA.
Tip gently curved.

GILLS Irrigating/Aspirating Cannula

Angled shaft with side-by-side front openings. Mirror finish.

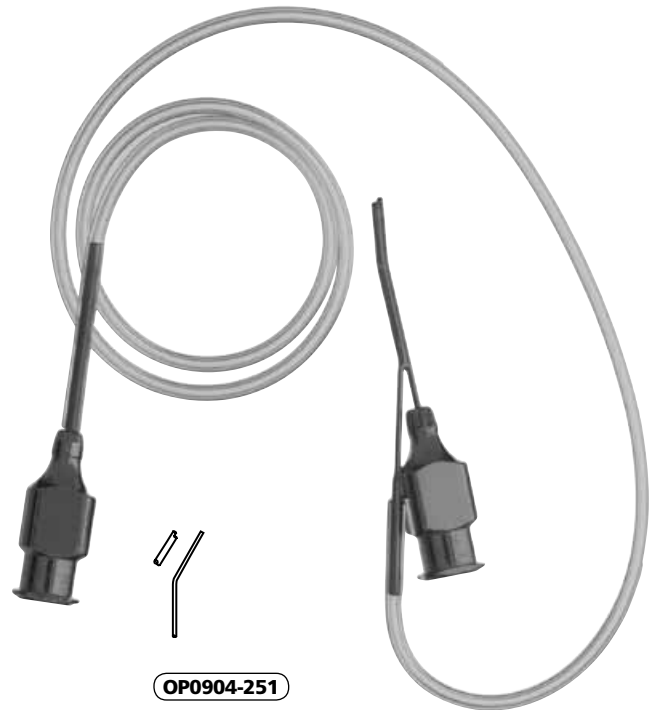

OP0904-251
23GA.

Cannulas/Cystotomes

Canules/Cystotomes
 Kanülen/Zystotome
 Cannule/Cistotomi
 Cánulas/Cistótomos
 Cânulas/Costótomos
 カニューレ/切開刀

MORRISON Irrigating/Aspirating Cannula

23GA angled aspiration tube. 25GA irrigation tube.

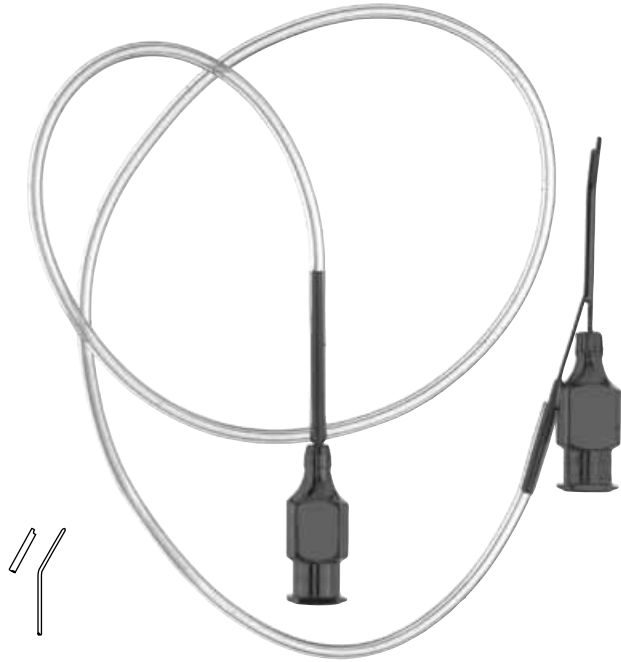

OP0904-451

Mirror finish.

SIMCOE Irrigating/Aspirating Unit

Dual barrel. Nickel and Chrome Plated. Silicone tubing.

OP25202

23GA.

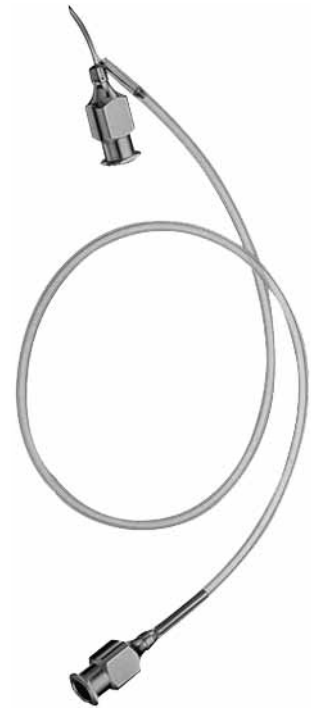

KELMAN Cystotomes

22GA. 32mm. Mirror finish.



OP0900-001

Sharp point with blunt edge.



KRATZ Cystotome

Shaft angled 60°. Sharp tip.



OP0900-101

22GA.



KNOLLE-KELMAN Cystotome

Sharp tip. Mirror finish.



OP0900-201

22GA. 32mm.



Cystotomes/Sondes/Dilatateurs
 Zystotome/Sonden/Dilatatoren
 Cistotomi/Sonde/Dilatatori
 Cistótomos/Sondas/Dilatadores
 Costótomos/Sondas/Dilatadores
 切開刀/プローブ/拡張器

McINTYRE Cystotome

Angled 10mm from tip to point.
 Shaft angled 45°. Sharp tip.
 Mirror finish.



OP0900-251

23GA.



DREWS Cystotomes

Sharp tip with double bend.
 Mirror finish.

OP0900-402

30 gauge.



Trabeculotomy Probes

Probe 10mm long.
 3mm between probes.
 Overall length
 2-3/8in (6cm).

OP0918-301

Right.

OP0918-302

Left.



the size 0 (0.8mm)
 the size 00 (0.7mm)
 the size 000 (0.5mm)
 the size 0000 (0.45mm)
 가 >
 Double-ended

BOWMAN Lacrimal Probes

Double-ended.
 Straight tip. Silver.
 Overall length
 5-1/2in (14cm).

OP7020-012

Sizes 1-2.

OP7020-034

Sizes 3-4.

OP7020-056

Sizes 5-6.

OP7020-078

Sizes 7-8.

OP7020-300

Sizes 00-0.

OP7020-700

Sizes 0000-000.



JONES Punctum and Lacrimal Canaliculus Dilator

Sizes 1-2.

OP7025

Stainless Steel.
 Overall length
 5in (12.7cm).



WILLIAMS Lacrimal Probes

Double-ended.
 Bulbous tip.
 Overall length
 5-1/2in (14cm).

OP7030-012

Sizes 1-2.

OP7030-034

Size 3-4.

OP7030-056

Size 5-6.

OP7030-078

Size 7-8.

OP7030-300

Size 00-0.



WORST Pigtail Probe

Double-ended, for
 repair of tear ducts.
 Mirror and Satin finish.

OP7060

Overall length
 5-3/4in (14.6cm).

2019-09-19



Dilators/Cannulas

Dilateurs/Canules
 Dilatoren/Kanülen
 Dilatori/Cannule
 Diladores/Cánulas
 Diladores/Cânulas
 拡張器/カニューレ

Lacrimal Dilator

Very fine blunt tip.

OP0918-401

Overall length
 3-1/8in (8cm).



RUEDEMAN Lacrimal Dilator

Short, 12mm taper,
 needle-type tip.
 Round, smooth handle.

OP0918-501

Overall length
 2-3/4in (7cm).



NETTLESHIP-WILDER Lacrimal Dilators

Overall length
 4in (10.2cm).



OP6971

Medium, fine taper.

OP6972

Long, delicate taper.



HEATH Punctum Dilator

Overall length
 4-1/8in (10.5cm).



OP6980

Sharp.



VEIRS Cannulas

Includes two sizes of straight cannulas,
 18GA and 15GA, each with one blunt,
 one sharp stylet; one curved cannula with
 blunt stylet; and one foot of polyethylene
 tubing. Cannulas are Chrome Plated.

OP7250

Complete set.

OP7250-001

Cannula only. 15GA. Straight.
 Working length 1-1/2in (3.8cm).

OP7250-002

Cannula only. 18GA. Straight.
 Working length 1-1/2in (3.8cm).

OP7250-003

Cannula only. 18GA. Curved.
 Working length 2in (5.1cm).



WILDER Lacrimal Dilator

Short, 19mm taper with blunt tip.
 Round, knurled handle.

OP0918-603

Overall length
 4-3/8in (11cm).



Dilatateurs/Sondes
 Dilatoren/Sonden
 Dilatori/Sonde
 Diladores/Sondas
 Dilatadores/Sondas
 拡張器/プローブ

QUICKER Lacrimal Intubation Probes

JONES taper point, one end. Other end, regular BOWMAN point. Malleable. Overall length 5-1/2in (14cm).

OP0918-701

Size 00.

OP0918-702

Size 0.

OP0918-703

Size 1.

OP0918-704

Size 2.

OP0918-705

Size 3.

OP0918-706

Size 4.



CASTROVIEJO Double-Ended Dilator



OP6975

Overall length 5in (12.7cm).



MULDOON Lacrimal Dilator

Straight tip, tapered.



OP6990

Overall length 4-1/8in (10.5cm).



BERENS Punctum Dilator

Mirror and Satin finish.



OP7000

Overall length 4-1/2in (11.4cm).



JACKSON Lacrimal Intubation Set

Two 20GA thin-wall 155mm JACKSON probes with 300mm silastic tubing fastened to probe.

OP0918-801

Blunt Tip.

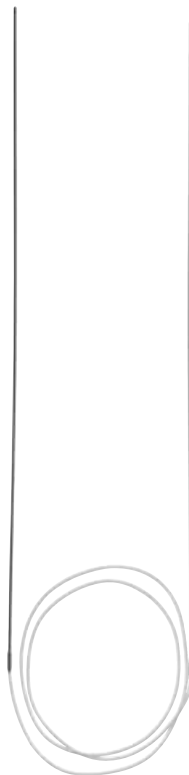

CATALANO Intubation Set

Two blunt probes 0.7mm diameter x 140mm long. 300mm silicone tubing attached to probes.

OP0918-821

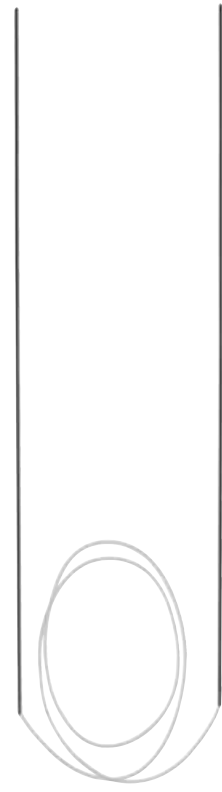

Calipers

Pieds à coulisse
Messschieber
Estesiometri
Calibres
Pinças
キャリパー

CRAWFORD Lacrimal Intubation Set

OP0918-851

Two olive tip probes 0.6mm diameter x 150mm long attached to 300mm silicone tubing. Mirror finish.

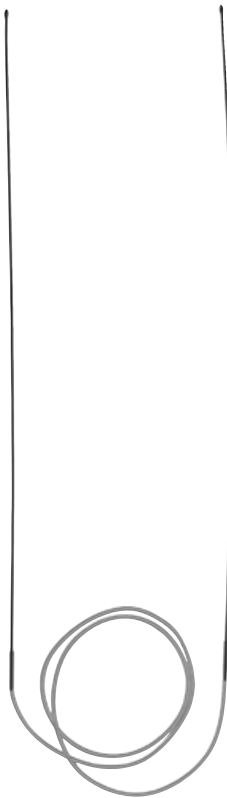

BODIAN Lacrimal Probe Set

OP0918-881

Two curved, blunt probes 1mm Diameter x 35mm long attached to 300mm long silicone tubing. Mirror finish.

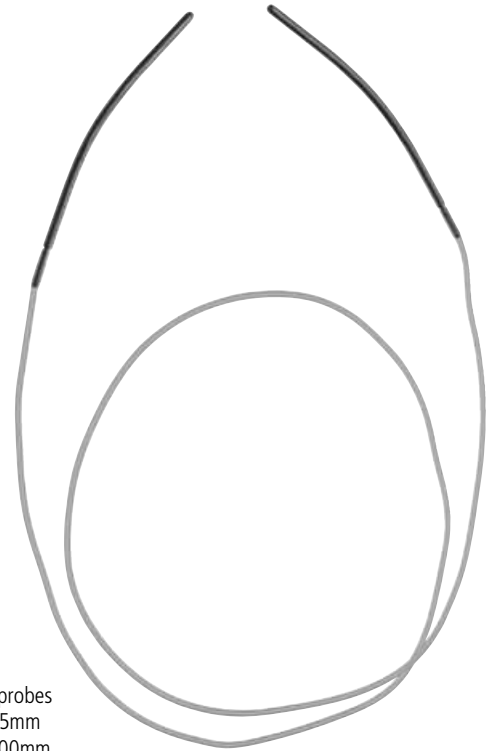

STAHL Caliper

0.5mm increments.

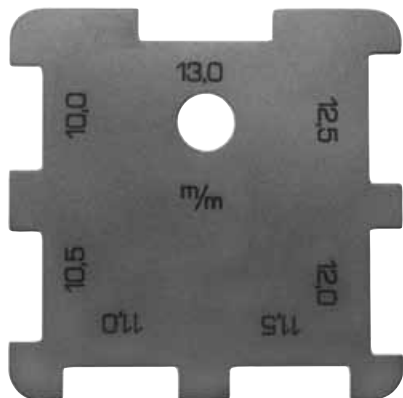

OP0924-801

JAMESON Caliper

Modified, with fine points, for measurements of recessions.

OP2700

Overall length, fully closed, 3-7/8in (9.8cm).



THORPE Caliper

Used for measurements.

OP2701

Overall length, fully closed, 4-1/4in (10.8cm).



Pieds à coulisse/Dépresseurs
 Messschieber/Depressoren
 Estesiometri/Abbassalingua
 Calibres/Depressores
 Pinças/Depressores
 キャリパー/デプレッサー

OSHER Internal Caliper

Measures up to 10mm
 on 1mm increments.

OP2702

Overall length
 3in (7.6cm).



CASTROVIEJO Calipers

Combination measuring and
 marking instrument.
 Thumbscrew to hold
 tips apart.
 Overall length
 3-1/4in (8.3cm).

◆ **OP2710**

Straight.

OP2710-001

Curved.



WEST Blunt Dissector and Elevator

OP7160

Overall length
 7-1/4in (18.4cm).



Blade Gauge

OP0924-851

With 20-micron increments.



SCHEPENS Scleral Depressors

Mirror finish.



OP0906-001

Small.
 No. 8 thimble size.

OP0906-002

Medium.
 No. 10 thimble size.

FLYNN Scleral Depressor

5mm loop. Lens loop-style tip.

OP0906-501

Overall length
 3-1/8in (8cm).



Depressors/Markers/Fixation Rings

Dépresseurs/ Marqueurs/ Anneaux de fixation
Depressoren/Marker/Fixierungsringe
Abbassalingua/Marcatori/Anelli di fissazione
Depresores/Marcadores/Anillos de fijación
Depressores/Marcadores/Anéis de fixação
デプレッサー/マーカ- /固定リング

SCHOCKERT Double-End Scleral Depressor

One rounded end, one hammer end. Mirror finish.
Overall length
5-1/2in (14.1cm).

OP0906-101

With pocket clip.



WILDER Scleral Depressor

OP2675

Overall length
4-3/4in (12.1cm).



URRETTS-ZAVALIA Depressor Fixation Pick

Pointed tip.

OP0906-511

Overall length
4-7/8in (12.3cm).



GASS Scleral Marker



OP0906-951

1.5mm diameter marking tip.

O'CONNOR Scleral Marker

3mm teardrop end and 1.5mm GASS marker end.

OP0906-401

Overall length
5-1/4in (13.3cm).



FINE-THORNTON Swivel Fixation Rings

Blunt Teeth.

OP0924-901

13mm diameter.
Overall length
4-3/4in (12cm).

OP0924-902

16mm diameter.
Overall length
4-7/8in (12.5cm).

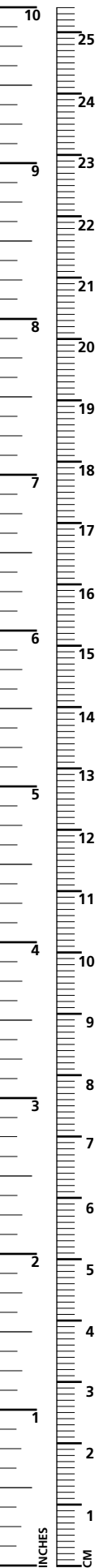

Anneaux de fixation/ Marqueurs
 Fixierungsringe/Marker
 Anelli di fissazione/Marcatori
 Anillos de fijación/Marcadores
 Anéis de fixação/Marcadores
 固定リング/マーカー

THORNTON Globe Fixation Ring

Multiple teeth.
 16mm diameter.

OP0924-881

Overall length
 4-3/4in (12cm).

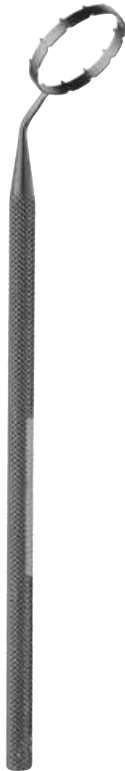

HOFMANN-THORNTON Globe Fixation Ring

Multiple teeth.
 16mm diameter.

OP0924-981

Overall length
 4-7/8in (12.5cm).



BORES Axis Marker

With MENENDEZ degree gauge.

OP0925-001

Overall length
 4in (10cm).



MENDEZ Degree Gauge

12mm inner diameter.

OP0924-951

Overall length
 4-1/2in (11.5cm).



Bores Optic Zone Markers

Overall length
 4-1/8in (10.5cm).

OP0925-104

3.5mm.

OP0925-111

6mm.

OP0925-112

7mm.

OP0925-113

8mm.



THORNTON Optic Zone Markers

With centering pin. Low profile.

Overall length
 4-1/8in (10.5cm).

OP0925-203

3.5mm.

OP0925-207

4.5mm.

OP0925-209

5mm.



Markers/Probes/Tonometer

Marqueurs/Sondes/Tonomètre
 Marker/Sonden/Tonometer
 Marcatori/Sonde/Tonometro
 Marcadores/Sondas/Tonómetro
 Marcadores/Sondas/Tonómetro
 マーカー/プローブ/トノメーター

HOFFER Optic Zone Markers

With extra-fine cross hairs.
 Overall length
 4-1/8in (10.5cm).

OP0925-306

4.25mm.

OP0925-309

5mm.

OP0925-310

5.5mm.

OP0925-311

6mm.

OP0925-313

8mm.



THORNTON Low Profile Markers

4mm long radial lines.
 Inner Diameter of
 Blades 4.5mm.
 Overall length
 4-3/8in (11cm).

OP0925-401

Four lines.

OP0925-402

Six lines.

OP0925-403

Eight lines.

OP0925-404

Twelve lines.



Magnetic Eye Probe

In plastic pocket case.
 Nickel Plated.

OP8570

Loop working length 2in (5.1cm).
 Probe length 2-3/4in (7cm).
 Handle length 3-1/2in (8.9cm).



SCHIOTZ Tonometer

Has etched scale inclined for easier reading from above, and supplied with 5.5 gram, 7.5 gram and 10 gram weights. Individually certified to meet Specification 5 of the Committee on Standardization of Tonometers of the AAO. Non-magnetic. Autoclavable.

OP9010

Complete in fitted
 case, with table of
 intraocular pressures.

