

ENT Instruments

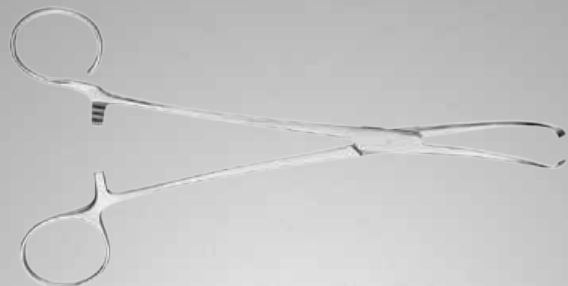
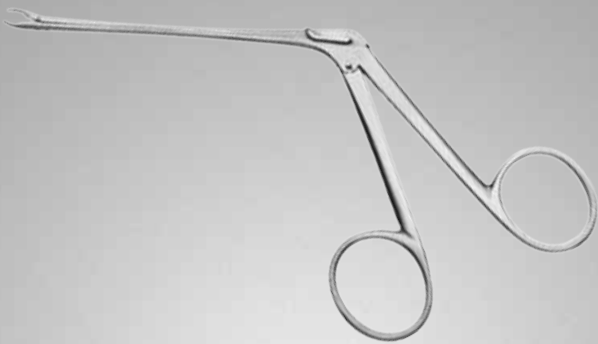

Specula

Spéculum
Spekula
Speculum
Espéculos
Espéculos
檢鏡

SHEA Speculum Holder

AU20490-1



Custom etching

Custom etching is available on stainless steel surgical instruments on new orders as they are purchased. Ask your customer support representative at **800.323.9088** for more information.

All Metal Ear Syringes

With two tips, bulbous and tapered.
Stainless Steel and Chrome Plated Brass.
Bright Finish.

AU5451

1 oz (30cc) capacity.

AU5452

2 oz (60cc) capacity.

AU5453

3 oz (90cc) capacity.

AU5454

4 oz (120cc) capacity.

AU5456

6 oz (180cc) capacity.

AU5457

Bulbous tip only.
Fits ear syringes
AU5451 to AU5456.

AU5458

Tapered tip only.
Fits ear syringes
AU5451 to AU5456.



REINER Ear Syringes

With shield and two tips, straight and bulbous.
Stainless Steel and Chrome Plated Brass.
Bright Finish.

AU5463

3 oz (90cc) capacity.

AU5464

4 oz (120cc) capacity.



GRUBER Ear Specula

Oval tip. Chrome Plated.



AU5101

Small. 2mm x 2.5mm I.D.



AU5102

Medium. 2.5mm x 3mm I.D.



AU5103

Large. 3mm x 4mm I.D.



TOYNBEE Ear Specula

Round tip. Chrome Plated.



AU5141

Small. 3mm I.D.



AU5142

Medium. 4mm I.D.



AU5143

Large. 5mm I.D.



GRUBER Ear Specula

Standard sizes. Oval tip. Chrome Plated.



AU5121

Small. 3mm x 4mm I.D.



AU5122

Medium. 4mm x 5mm I.D.

AU5123

Large. 5mm x 6mm I.D.

FARRIOR Ear Specula

Glare-reducing interior surface. Oval tip.

| Tip Angled 20° | Flat Tip | Internal Diameter | |
|----------------|-----------------|-------------------|--|
| AU5230 | AU5230-3 | 3mm x 4mm | |
| AU5232 | AU5232-4 | 4mm x 5mm | |
| AU5233 | | 4.5mm x 5.5mm | |
| AU5234 | AU5234-5 | 5mm x 6mm | |
| AU5235 | | 5.5mm x 6.5mm | |
| AU5236 | AU5236-6 | 6mm x 7mm | |
| AU5237 | | 6.5mm x 7.5mm | |
| AU5238 | AU5238-7 | 7mm x 8mm | |
| AU5239 | | 7.5mm x 8.5mm | |



Specula

Spéculum
Spekula
Speculum
Espéculos
Espéculos
検鏡

HOUSE Stapes Specula

Round tip. Chrome Plated.



AU15005

4.5mm I.D.



AU15010

5.5mm I.D.



AU15015

6.5mm I.D.



BOUCHERON Ear Specula

Round tip. Chrome Plated.



AU5181

3mm I.D.



AU5182

4mm I.D.



AU5183

5mm I.D.



AU5184

6mm I.D.



AU5186

8mm I.D.



AU5185

7mm I.D.



AU5187

9mm I.D.



McHUGH Ear Specula

Oval tip. Chrome Plated.



AU5245

3.5mm x 5mm I.D.



AU5247

4.5mm x 6mm I.D.



AU5249

5.5mm x 7mm I.D.



AU5251

6.5mm x 8mm I.D.



AU5253

7.5mm x 9mm I.D.



AU5255

8.5mm x 10mm I.D.



BRUENING Specula

Round tip. Chrome Plated.



AU5314

Small. 4mm I.D.



AU5315

Medium. 5mm I.D.



AU5316

Large. 6mm I.D.



LATHBURY Cotton Applicators

Nickel-silver alloy.
Overall length
6in (15.2cm).



AU5620

Triangular tip.
Light model.



AU5626

Twisted tip.
Light model.



AU5622

Triangular tip.
Regular model.



AU5628

Twisted tip.
Regular model.



ROBERTS Cotton Applicators

Triangular tip.

AU5631

Working length 5in (12.7cm).

AU5632

Working length 6in (15.2cm).



BROWN or DEAN Cotton Applicators

Aluminum handle.
Overall length 6in (15.2cm).



RH250

Triangular copper tip.



RH254

Triangular nickel-silver alloy tip.



JANSEN-NEWHART Mastoid Probe

Tip length 4mm.

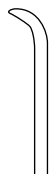

AU5670

Overall length
6-1/2in (16.5cm).



ALLPORT Mastoid Searcher

Tip length 3mm.



AU5680

Overall length
6-1/2in (16.5cm).



ROSEN Probe



AU12080

Overall length
6-1/4in (16cm).



Curettes/Crochets
 Küretten/Haken
 Curette/Uncini
 Curetas/Ganchos
 Curetas/Ganchos
 キュレット/フック

ALLPORT-BABCOCK Mastoid Searcher



AU5685

Overall length
 6-1/2in (16.5cm).



Mastoid Searchers

Overall length 6-1/2in (16.5cm).



AU5686

1mm.

AU5687

2mm.

AU5688

3mm.



LILLIE Attic Hooks

Tip length 4mm.
 Overall length 7in (17.4cm).



AU5690

Angled 50°.



AU5695

Angled 90°.



Plain Ear Spoon and Hook

AU5550

Overall length
 5-1/2in (14cm).



BILLEAU Ear Loops

Oval, flexible loop. Matte,
 Mirror and Satin finish.
 Overall length 7in (17.5cm).



AU5610

Small.
 5.4mm x 3.9mm.

AU5610-001

Small,
 Teflon® coated.
 5.4mm x 3.9mm.



AU5611

Medium.
 7.7mm x 5.2mm.



AU5612

Large.
 9.1mm x 5.7mm.



WULLSTEIN Ring Curettes

Sharp. Overall length 5-5/8in (14.3cm).



AU14100

Size 000.
 Ring tip diameter 1.3mm O.D.



AU14102

Size 00.
 Ring tip diameter 1.8mm O.D.



AU14104

Size 0.
 Ring tip diameter 2.3mm O.D.

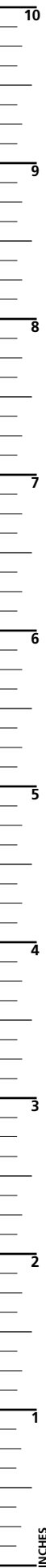

FREIMUTH Ear Curettes

Serrated loop. Overall length 6-1/4in (16cm).



AU5600

Small loop, 2.3mm x 4.5mm.



AU5601

Large loop, 3.5mm x 6.6mm.

BUCK Ear Curettes

Sharp. Overall length 5-7/8in (15cm). Matte and Mirror finish.



AU5580

Size 00, 2mm O.D.



AU5581

Size 0, 2.3mm O.D.



AU5582

Size 1, 3mm O.D.



AU5583

Size 2, 3.6mm O.D.



AU5584

Size 3, 4mm O.D.

BUCK Ear Curettes

Blunt. Overall length 5-7/8in (15cm).



AU5590

Size 00, 2mm O.D.



AU5591

Size 0, 2.3mm O.D.



AU5592

Size 1, 3mm O.D.



AU5593

Size 2, 3.6mm O.D.



AU5594

Size 3, 4mm O.D.

DERLACKI Curette

Forward bent. Diameter 1.5mm.



AU12392

Overall length 6-1/8in (15.5cm).

HOUSE Stapes Curettes

Double-ended.
3mm x 1.7mm and
3mm x 1.9mm wide
oval cups. Overall
length 7-1/8in (18.1cm).



AU12450

Slight angle.



AU12452

Strong angle.

HOUSE Stapes Curettes

Double-ended.
Overall length
6-1/4in (15.9cm).



AU12454

2.5mm x 1.8mm and
3mm x 1.8mm oval cups.

AU12456

2mm x 1.5mm and
2.9mm x 1.5mm oval cups.

Curettes

Curettes
Küretten
Curette
Curetas
Curetas
キュレット

HOUSE-PAPARELLA Stapes Curette

No. 19. Double-ended with oval cups.
3.3mm x 2mm and 2.5mm x 1.6mm wide.



AU13720

Overall length
6-1/4in (15.9cm).



PAPARELLA Stapes Curette

No. 20. Double-ended with round cups, 0.9mm and 1.5mm.



AU13725

Overall length
6-1/4in (15.9cm).



PAPARELLA Angled Ring Curette

No. 12. Angled 20°. Blunt 2mm O.D. ring.



AU13775

Overall length
6-1/2in (16.5cm).



SHEA Curette

Cup 1.6mm x 2mm.
Angled shaft, flat handle.



AU20410

Overall length
5-1/2in (14cm).



LEMPERT Fine Curettes

Oval cup. Overall length 7-7/8in (20cm).



AU11300

Size 6/0.
Cup 2.3mm x 1.5mm wide.



AU11302

Size 5/0.
Cup 2.5mm x 1.8mm wide.



AU11304

Size 0000.
Cup 3.2mm x 2.1mm wide.



AU11306

Size 000.
Cup 3.3mm x 2.4mm wide.



AU11308

Size 00.
Cup 4.3mm x 2.7mm wide.



AU11310

Size 0.
Cup 4.6mm x 3mm wide.



AU11312

Size 1.
Cup 5.1mm x 3.6mm wide.



AU11314

Size 2. Cup 6mm x 4mm wide.

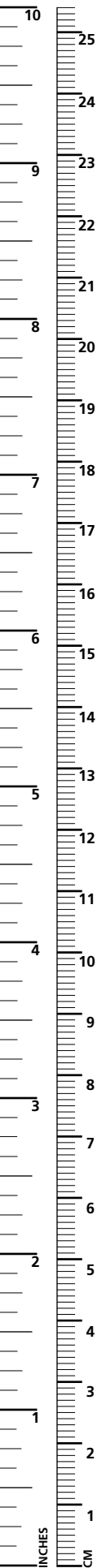

Curettes/Manches de couteau
 Küretten/Messergriffe
 Curette/Impugnatura di bisturi
 Curetas/Mangos de cuchillos
 Curetas/Cabos de facas
 キュレット/ナイフハンドル

LEMPERT-Type Curettes

Overall length 7in (17.8cm).



AU16015

Size 3.



AU16020

Size 5.

GUILFORD-WRIGHT Micro Bone Curettes

Overall length 5-1/8in (13cm).



AU13330

2.1mm x 1.2mm wide.
 Slightly angled oval cup.



AU13336

3mm x 1.8mm wide.
 Slightly angled oval cup



AU13334

2.9mm x 1.5mm wide.
 Slightly angled oval cup.



AU13338

2.6mm x 1.5mm wide.
 Angled oval cup.



HOUSE Myringotomy Knife Handle

AU17370001

Overall length
 3-3/4in (9.5cm).



HOUSE Myringotomy Blade

Fits handle AU17370001.
 Spear-shaped. Sterile.
 For single use only.

◆ **AU17370002**

Overall length
 3in (7.6cm).



Genesis Extra-Long Container System

Maximize the protection of your longer instruments and trays with the V. Mueller brand Genesis extra-long container system. Now you can rely on the sterilization assurance of a rigid container system for longer instruments.

Knives

Couteaux
Messer
Bisturi
Cuchillos
Facas
ナイフ

HOUSE Blade

Fits handle AU17370001. Non-sterile.

AU17370-3

Overall length
3in (7.6cm).



Ear Operating Instrument

Fits handles AU6022 and AU6024.

AU6003

Curved blade.
Shaft length
3in (7.6cm).



MUELLER Universal Handle

AU6022

Overall length
3-1/2in (8.9cm).



GUILFORD-WRIGHT Double-Edged Sickle Knife

Double-edged blade, length 8mm.



AU13410

Overall length
5-1/2in (14cm).



SEXTON Ear Knife

Straight. Blade 10mm x 1.5mm wide.
Mirror and Satin finish.



AU5710

Overall length
7-1/4in (18.4cm).



Tympanum Perforators

Angled. Overall length 7in (17.5cm).



AU5720

Vertical spear blade,
6mm x 2mm wide.
Mirror and Satin finish.



AU5722

Straight blade,
18mm x 2mm wide.



ROYCE Tympanum Perforators

Bayonet-shaped. Blade fits in handle when not in use.



AU5740

Straight.
Vertical spear blade,
5.2mm x 2mm wide.
Brass handle.
Overall length
7-1/8in (18.1cm).



ROYCE Tympanum Perforators

Blade fits in handle when not in use. Angled.
Overall length 6in (15.2cm).



AU5745

Vertical spear blade,
6mm x 2mm wide.

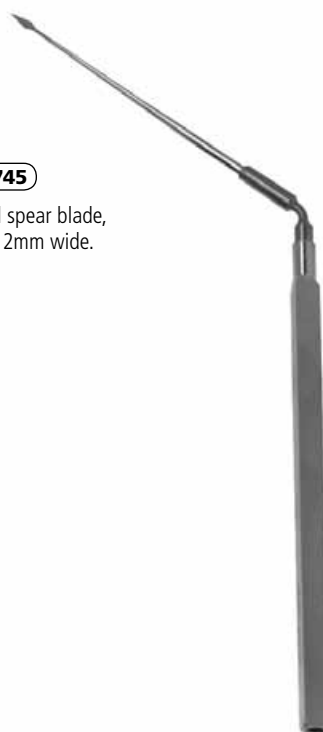

McHUGH Flap Knife

Triangular blade, 4mm x 3mm wide.



AU11110

Overall length
6-1/2in (16.5cm).



HARRISON Knives

Short blade. Overall length
6-1/4in (15.9cm).



AU12360

Angled 45°.



AU12362

Angled 90°.



GUILFORD-WRIGHT Flap Knife

Blade 3.7mm x 2.5mm wide.
Mirror and Satin finish.



AU13400

Overall length
6-1/4in (15.9cm).



TABB Pick Knife

Blade length 1.5mm, shank 0.4mm
gradually tapering to 1mm and
1.5mm before the handle.



AU13640

Overall length
6in (15.2cm).



Knives

Couteaux
Messer
Bisturi
Cuchillos
Facas
ナイフ

TABB Double-Ended Flap Knife

Blades 2mm x 1.5mm wide,
angled 20° and 45°.

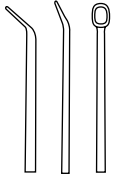

AU13650

Overall length
6-1/4in (15.8cm).

SHEA Incision Knife

Oval blade, 1.5mm wide.
Angled shaft.



AU20400

Overall length
6-1/4in (15.9cm).

AUSTIN Dissection Knife

Blade 0.5mm wide, angled 45°.



AU21007

Working length
2-3/4in (7cm).
Overall length
6-1/4in (16cm).

ROSEN Incision Knife

Angled blade, 4mm.



AU12000

Overall length
6-1/4in (16cm).

WIET Roller Knife

Round blade, 3mm.



AU12501

Overall length
6-1/2in (16.5cm).

WIET Right Angle Knife

Blade 2mm, angled 90°.



AU12504

Overall length
6-1/2in (16.5cm).

WIET Round Weapon Elevator Knife

Round. 2mm blade, angled 45°.



AU12509

Overall length
6-1/2in (16.5cm).



CULBERTSON Canal Knife

Round blade, 1.4mm wide.



AU12900

Overall length
6-1/4in (15.9cm).



McCABE Canal Knives

Sharp, round blade, angled 45°.
Square, hollow handle.
Mirror and Satin finish.
Overall length 6-1/4in (15.9cm).



AU12920

Diameter 2mm.



AU12930

Diameter 2.5mm.



SCHUKNECHT Roller Knives

Overall length 6-1/2in (16.5cm).



AU18100

3mm horizontal round blade.



AU18110

3mm vertical round blade.



SCHUKNECHT Sickle Knife

7mm single-edged blade, angled 17°.
Mirror and Satin finish.



AU19060

Overall length
6-1/4in (15.9cm).



DERLACKI Capsule Knives

Overall length 6-1/4in (15.9cm).



AU12330

Slightly curved blade.

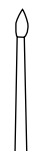

AU12332

Angled 20°.



Dissectors/Knives

Dissecteurs/Couteaux
 Dissektoren/Messer
 Dissettori/Bisturi
 Diseccionadores/Cuchillos
 Escalpelos/Facas
 切開器/ナイフ

McCABE Flap Knife Dissector

Double-ended, with 2mm x 3.5mm wide blades angled 20° and 45°. Square, hollow handle.

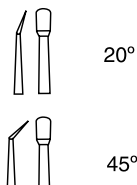

AU12950

Overall length 7-1/4in (18.4cm).



TABB Myringoplasty Knives

Double-ended. Overall length 6-1/4in (15.8cm).



AU13620

1mm wide blade angled 90° and 2mm wide blade angled 120°.



AU13622

1.3mm wide blades angled 90° and 115°.



AU13624

1.1mm wide blades angled 25° and 45°.



HOUSE Knives

Mirror and Satin finish. Overall length 6-1/2in (16.5cm).



AU15040

Sickle, No. 1.



AU15050

Lancet, No. 2.



SHEEHY Round Knives

"Weapon-style." Mirror and Satin finish. Overall length 6-1/2in (16.5cm).



AU15060

Small. Cup 2mm wide.



AU15062

Large. Cup 2.5mm wide.



HOUSE Incudostapedial Joint Knife

Blade 1mm, angled 45°.



AU15260

Overall length 6-1/2in (16.5cm).



SHEEHY Myringotomy Knife

Blade length 6.5mm.



AU16010

Overall length 6-1/2in (16.5cm).



PAPARELLA Canal Knives

Mirror and Satin finish.
Overall length 6-1/2in (16.5cm).



AU13700

No. 1. Straight blade,
length 2mm, replaceable.

AU13700001

Replacement blade for AU13700.



AU13702

No. 2. Angled blade,
length 2mm, replaceable.

AU13702001

Replacement blade for AU13702.



PAPARELLA Drum Elevator-Knife

No. 3. Sharp. Tip 1.4mm.



AU13710

Overall length
6-1/2in (16.5cm).



PAPARELLA Incudostapedial Knife

No. 4. Blade 0.5mm wide.



AU13715

Overall length
6-1/2in (16.5cm).



PAPARELLA Sickle Knives

Overall length 6-1/2in (16.5cm).



AU13790

No. 14, right.



AU13792

No. 15, left.
Mirror and Satin finish.



HOUGH Knife

Round blade angled 45°,
2mm diameter. Angled shaft.



AU20809

Overall length
6in (15.2cm).



AUSTIN Sickle Knife

Sickle blade. Mirror and Satin finish.



AU21017

Working length
2-3/4in (7cm).
Overall length
6-5/16in (16cm).



Needles

Aiguilles
Nadeln
Aghi
Agujas
Agulhas
針

ROSEN Fenestrometer

Graduated in millimeters, to 4mm maximum. Mirror and Satin finish.



AU11395

Overall length 6-3/8in (16.2cm).



PAPARELLA Fenestrometer

No. 13. Measuring 4mm wide.



AU13780

Overall length 6-1/2in (16.5cm).



SHAMBAUGH Palpating Needles

Overall length 6-1/4in (15.9cm).



AU12255

Straight. Fine.



AU12260

Straight. Super-fine.



HOUSE Needle

Slightly curved with heavy tip.



AU15100

Overall length 6-1/2in (16.5cm).



HOUSE-ROSEN Needles

Slightly curved. Overall length 6-1/2in (16.5cm).



AU15110

Delicate tip.



AU15112

Regular tip.



HOUSE Stapes Needle

Fully curved tip.



AU15120

Overall length 6-1/2in (16.5cm).

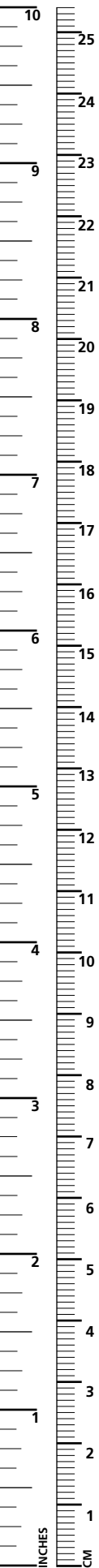

HOUSE-BARBARA Shattering Needle

Straight tip. Malleable shaft.



AU15130

Overall length
6-1/2in (16.5cm).



SCHUKNECHT Needle

Straight, rigid needle, angled 17°.



AU19040

Overall length
6-1/4in (15.9cm).



WIET ROSEN Needle

Sharp, straight point.

AU12511

Overall length
6-1/2in (16.5cm).



JORDAN Needles

Bayonet-shaped. Straight shaft.
Overall length 6-1/2in (16.5cm).



AU13130

Heavy shaft.



AU13135

Fine shaft.



SAUNDERS-PAPARELLA Straight Needle

No. 5. Fine, malleable
2-3/4in (7cm) shaft.



AU13750

Overall length
6-1/2in (16.5cm).



PAPARELLA Straight Needle

No. 6. Heavy, malleable
2-3/4in (7cm) shaft.



AU13752

Overall length
6-1/2in (16.5cm).



Picks

Pics
Picken
Becchi
Púas
Palhetas
ピック

WIET Small Right-Angle Pick

Tip 0.5mm wide.



AU12505

Overall length
6-1/2in (16.5cm).



WIET Large Right-Angle Pick

Tip 1mm wide, angled 90°.



AU12506

Overall length
6-1/2in (16.5cm).



WIET-HOUSE Large Curved Pick

Tip 2mm wide.



AU12507

Overall length
6-1/2in (16.5cm).



WIET 45° Pick

Tip 1mm wide.



AU12510

Overall length
6-1/2in (16.5cm).



GUILFORD-WRIGHT Foot Plate Picks

0.15mm wide pick. Overall length
5-1/2in (14cm).



AU13352

Angled 45°.



AU13354

Angled 90°.



PAPARELLA Picks

Tip 0.9mm wide. Overall length
6-1/2in (16.5cm).



AU13810

No. 16, right.



AU13812

No. 17, left.

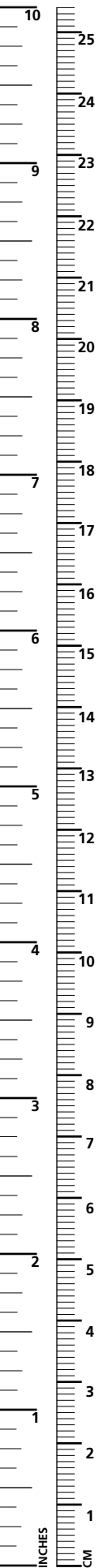

GUILFORD-WRIGHT Stapes Pick

Heavy. Angled 90°.



AU13455

Overall length
5-1/2in (14cm).



FARRIOR Anterior Foot Plate Picks

Angled shaft.
Tip curved right.
Overall length
5-7/8in (14.9cm).



AU14300

With notch 5mm from distal tip.



FARRIOR Posterior Foot Plate Picks

Angled shaft.
Tip curved left.
Overall length
5-7/8in (14.9cm).



AU14305

With notch 5mm from distal tip.



FARRIOR Oval Window Excavator and Piston Gauges

Angled shaft. Overall length
5-7/8in (14.9cm).

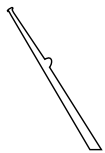

AU14320

Tip diameter 0.4mm.
With notch 5mm from distal tip.

AU14320001

Tip diameter 0.4mm.
Without notch.

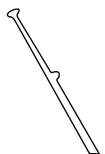

AU14325

Tip diameter 0.6mm.
With notch 5mm from distal tip.

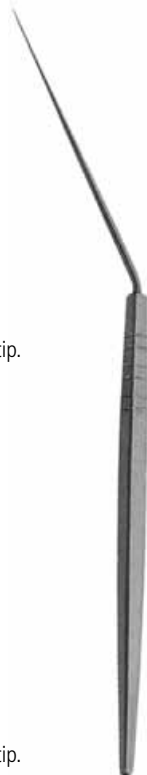

HOUGH Stapedectomy Foot Plate Picks

Tip 0.1mm wide.
Overall length
5-7/8in (14.9cm).



AU20780

Tip angled 15°.



AU20785

Tip angled 45°.



AU20795

Slightly curved tip.



HOUGH Stapedectomy Foot Plate Pick

Straight tip, 0.65mm wide.
Angled 90°.



AU20790

Overall length
5-7/8in (14.9cm).



Picks

Pics
Picken
Becchi
Púas
Palhetas
ピック

AUSTIN Picks

Working length 2-3/4in (7cm).
Overall length 6-1/4in (16cm).



AU21013

Tip length 0.8mm,
angled 25°.



AU21014

Tip length 1mm,
angled 45°.



AU21015

Tip length 1mm,
angled 90°.



AU21016

Tip length 3mm,
angled 90°.



SHAMBAUGH Microscopic Hook

Fine tip, angled 90°.
Mirror and Satin finish.



AU12300

Overall length
6-1/8in (15.6cm).



SHAMBAUGH Hook or Spud

Narrow flat inner surface. Angled 90°.



AU12352

Overall length
6-1/4in (15.9cm).



SHAMBAUGH Hook

Fine. Hook 0.5mm wide. Angled 90°.
Mirror and Satin finish.



AU12354

Overall length
6-1/4in (15.9cm).



V. Mueller Detergents

CareFusion offers a full line of instrument processing products such as presoak sprays, detergents, enzymatics and specialty products to clean and protect your surgical instrumentation. Synonymous with the world's finest surgical instruments, V. Mueller detergents offer cleaning solutions to help clean and protect your high quality surgical instrumentation.

SHEA Fenestration Hook

Hook angled 45°, length 0.7mm.



AU20420

Overall length
6-1/4in (15.9cm).

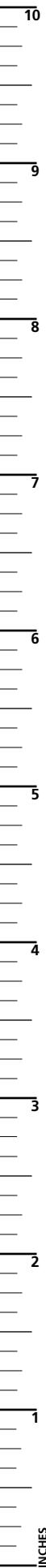

SHEA Oblique Hook

Slightly blunt tip, 0.5mm wide.
Hook angled 90°, length 3.6mm.



AU20425

Overall length
6-1/4in (15.9cm).



SHEA Fistula Hook

Hook angled 90°, length 0.8mm.



AU20435

Overall length
6-1/4in (15.9cm).



SHEA Stapes Hook

Hook angled 90°, length 0.7mm.



AU20460

Overall length
6-1/4in (15.9cm).



HOUSE Crura Hook

Hook 0.5mm, angled 90°.
Malleable shaft.



AU15135

Overall length
6-1/2in (16.5cm).



HOUSE Oval Window Hooks

Malleable shaft. Hook 0.3mm, angled 90°.
Overall length 6-1/2in (16.5cm).



AU15140

Fine shaft.

AU15150

Medium shaft.



HOUSE Foot Plate Hook

Hook 0.25mm, angled 30°.
Malleable shaft.



AU15155

Overall length
6-1/2in (16.5cm).



Picks

Pics
Picken
Becchi
Púas
Palhetas
ピック

HOUSE Strut Hooks

Malleable shaft. Angled 90°. Overall length 6-1/2in (16.5cm).



AU15165

Fine shaft. 0.75mm tip.



AU15170

Medium shaft. 1mm tip.



AU15175

Heavy shaft. 1.5mm tip.



AU15180

Heavy shaft. 3mm tip.



SCHUKNECHT Foot Plate Hooks

Mirror and Satin finish. Overall length 6-1/4in (15.9cm).



AU19000

Length 0.4mm. Bent forward.



AU19010

Length 0.4mm. Bent downward.



AU19005

Length 0.7mm. Bent forward.



AU19015

Length 0.7mm. Bent downward.



JORDAN Hooks

Bayonet shaft. 1mm tip. Overall length 6-1/2in (16.5cm).



AU13160

Tip angled up 45°.



AU13165

Tip angled right 90°.



AU13170

Tip angled down 90°.



HOUGH-SAUNDERS Stapes Hoe

No. 7. Malleable 2-3/4in (7cm) shaft. Tip 0.8mm, angled 90°.



AU13760

Overall length 6-1/2in (16.5cm).



SAUNDERS-PAPARELLA Stapes Hooks

Malleable 2-3/4in (7cm) shaft. Hook angled 90°. Overall length 6-1/2in (16.5cm).



AU13770

No. 8. Hook 0.3mm.



AU13772

No. 9. Hook 0.5mm.



AU13774

No. 10. Hook 0.75mm.



SCHUKNECHT Stapes Hooks

Angled 90°. Mirror and Satin finish. Overall length 6-1/4in (15.9cm).



AU19030

1mm hook.



AU19032

2mm hook.

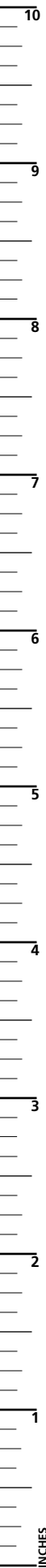

AUSTIN Foot Plate Hooks

Working length 2-3/4in (7cm).
Overall length 6-1/4in (16cm).



AU21020

Tip length 0.6mm,
angled 90°.



AU21021

Tip length 1mm,
angled 90°.

DERLACKI Mobilizer

Diamond-shaped tip.



AU12270

Overall length
6-1/8in (15.6cm).



WIET DERLACKI Modified Mobilizer

Angled, cone-shaped,
serrated 1mm tip.

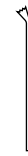

AU12503

Overall length
6-1/2in (16.5cm).



HOUGH Excavators

"Whirlybird-style".
Overall length 6in (15.2cm).



AU20700

Curved left. Blade
1mm wide, length 4mm.



AU20705

Curved right. Blade
1mm wide, length 4mm.



AU20720

Curved left. Blade
0.7mm wide, length 3mm.



AU20725

Curved right. Blade
0.7mm wide, length 3mm.

HOUGH Excavators

"Hoe-style". Angled shaft. Overall length
5-7/8in (14.9cm).



AU20800

Blade 0.5mm wide, length 0.8mm. Angled 45°.



AU20802

Blade 0.25mm wide, length 0.8mm. Angled 90°.



Elevators

Élévateurs
Heber
Elevatori
Elevadores
Elevadores
エレベーター

HOUGH Oval Window Excavators

Heavy. Overall length
6-1/4in (15.9cm).

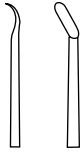

AU20805

Angled left.

HOUGH Drum Scraper

Blade angled 90°. Angled shaft.



AU20820

Overall length
5-3/4in (14.6cm).

AUSTIN Excavators

Blade 1mm wide. Working length 2-3/4in (7cm). Overall length 6-1/4in (16cm).



AU21010

Angled left.



AU21011

Angled right.

GUILFORD-WRIGHT Duckbill Elevators



AU13300

Curved. Blade 4mm wide. Mirror and Satin finish. Overall length 5-5/8in (14.3cm).



AU13310

Curved. Blade 2.2mm wide. Mirror and Satin finish. Overall length 5-1/2in (14cm).

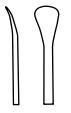

AU13305

Fully curved. Blade 3.5mm wide. Overall length 6-1/2in (16.5cm).

HOUSE Stapes Elevators

"Gimmick-style". Angled tip, 13mm x 1mm wide. Overall length 6-1/2in (16.5cm).



AU15080

Regular model.



AU15090

Insulated model. Tip mirror finish.

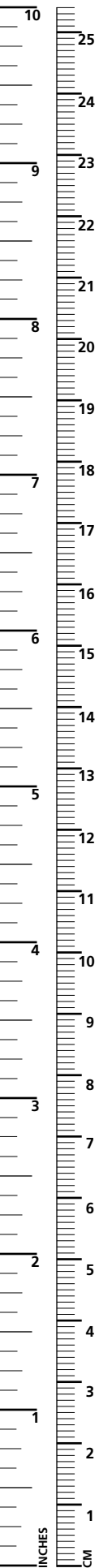

HOUSE Endaural Elevator

Straight. Tip 1mm wide.

AU15085

Overall length
6-1/2in (16.5cm).



HOUSE Excavator

Hook angled 90°. Malleable shaft.



AU15160

Overall length
6-1/2in (16.5cm).



Tungsten carbide particles are bonded to jaw surfaces in these needle holders, creating a premium Delicate Touch gripping surface. Instruments are available in spring handle and ring handle designs, and in a variety of jaw styles and sizes.

SCHUKNECHT Excavators

"Whirlybird-style". Small tip. Mirror and Satin finish. Overall length 6-1/4in (15.9cm).



AU19020

Angled left.



AU19025

Angled right.



WIET Elevator

"Gimmick-style". Angled, blunt. Tip 1mm wide.



AU12502

Overall length
6-1/2in (16.5cm).



TABB Elevator

Tip angled 45°, blade length 1mm.



AU13600

Overall length
6-1/4in (15.9cm).



Elevators

Élévateurs
Heber
Elevatori
Elevadores
Elevadores
エレベーター

PAPARELLA Duckbill Elevator

No. 18. Blade 3mm wide.

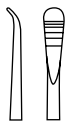

AU13830

Overall length
6-1/2in (16.5cm).



AUSTIN Duckbill Elevator

Slightly curved blade, 2.2mm wide.



AU21003

Working length
2-3/4in (7cm).
Overall length
6-1/4in (16cm).



AUSTIN Right Angle Elevator

Blade 2mm wide, angled 90°.



AU21004

Working length
2-3/4in (7cm).
Overall length
6-1/4in (16cm).



AUSTIN Foot Plate Elevator

Blade length 1mm, angled 90°.



AU21019

Working length
2-3/4in (7cm).
Overall length
6-1/4in (16cm).



LEMPERT Narrow Elevator

Blade 3.2mm wide.

AU11120

Overall length
7-1/8in (18.1cm).



SHAMBAUGH Narrow Elevators

Overall length 7-1/2in (19cm).



AU11150

Blade 2.5mm wide.

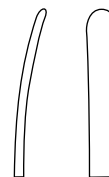

AU11154

Blade 4mm wide.



AU11152

Blade 3.5mm wide.

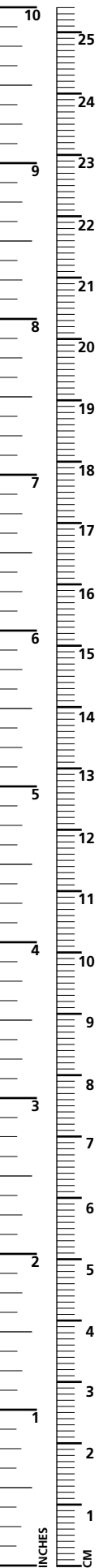

Élévateurs/Limes/Rugines
 Heber/Feilen/Raspeln
 Elevatori/Lime/Raschietti
 Elevadores/Limas/Raspadores
 Elevadores/Limas/Raladores
 エレベーター/やすり/石目やすり

SHAMBAUGH Narrow Elevator

Curved. Blade 2mm wide.



AU11156

Working length
 2-3/8in (6cm).
 Overall length
 7-1/4in (18.4cm).



LEMPERT Heavy Elevator

Blade 5mm wide.

AU11170

Overall length
 7-3/8in (18.7cm).



SHEA Long Back-Handed Elevator

Blade 2mm wide, angled 45°.



AU20477

Overall length
 6-1/4in (15.9cm).



WIET FARRIOR Rasp

Round, sharp. 0.5mm tip.



AU12508

Overall length
 6-1/2in (16.5cm).



WIET Measuring Devices

Overall length 6-1/2in (16.5cm).



AU12512350

3.5mm.



AU12512375

3.75mm.

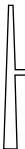

AU12512425

4.25mm.

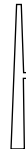

AU12512450

4.5mm.



McCABE Measuring Instrument

Slightly curved round shaft with calibrations
 at 3mm, 4mm and 5mm.



AU12830

Overall length
 6-1/8in (15.6cm).



Limes/Rugines
 Feilen/Raspeln
 Lime/Raschietti
 Limas/Raspadores
 Limas/Raladores
 やすり/石目やすり

McCABE Perforation Rasps

Rasp on inside of blade.
 Overall length 6-1/4in (15.9cm).

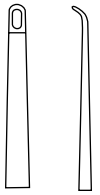

AU12990

Angled 45°.

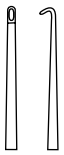

AU12995

Blade angled 120°.
 Square solid handle.

HOUSE Measuring Rods

Overall length 6-1/2in (16.5cm).



AU15270

3.5mm.

AU15285

5mm.



AU15275

4mm.



AU15280

4.5mm.

HOUGH Stapedial Foot Plate Augers

Overall length 5-3/4in (14.6cm).



AU20830

For 0.8mm piston.



AU20832

For 0.6mm piston.

AUSTIN Strut Caliper and Measuring Gauge

First prong 3.5mm.
 Groove 4mm.
 Second prong 4.5mm.



AU21022

Working length
 2-3/4in (7cm).
 Overall length
 6-1/4in (16cm).

ROSEN Separator

Small size.
 Concave blade tip,
 1.5mm wide.



AU12050

Overall length
 6-1/4in (16cm).

ROSEN Separator

Large size.
 Concave blade tip,
 2mm wide.



AU12060

Overall length
 6-1/4in (16cm).

Ciseaux/Dissecteurs
 Meißel/Dissektoren
 Scalpelli/Dissettori
 Cinceles/Disseccionadores
 Cinzéis/Escalpelos
 のみ/切開器

DERLACKI Chisels

Narrow blade, 0.5mm wide.
 Overall length 6-1/4in (15.9cm).

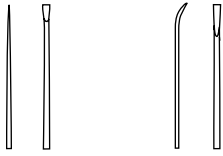

AU12310

Straight.

AU12314

Angled 20°.

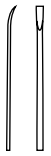

AU12312

Angled 12°.



HOUSE Separators

Bayonet-style. Overall length
 6-5/8in (16.8cm).



AU15065

1.5mm tip,
 slightly curved.



AU15070

1mm tip, curved.



CRABTREE Dissectors

"Jimmy." Malleable shaft.
 Overall length 6-1/2in (16.5cm).



AU15190

Large tip.
 Blade 2mm.



AU15195

Small tip.
 Blade 1.3mm.



HOUSE Foot Plate Chisels

Malleable shaft. Overall length
 6-1/4in (15.9cm).



AU15200

Straight.
 Blade 0.6mm wide.



AU15210

Strongly curved.
 Blade 0.5mm wide.



SCHUKNECHT Spatula

1.4mm wide, angled 17°.



AU19050

Overall length
 6-1/4in (15.9cm).



AUSTIN Attic Dissector

Tip length 5mm, angled 90°.



AU21009

Working length
 2-3/4in (7cm).
 Overall length
 6-1/4in (16cm).



Forceps

Forceps
Zangen
Pinze
Fórceps
Fórceps
鉗子

TOBEY Ear Forceps

Very delicate. 2mm x 4mm wide cup jaws.
Overall length 5-1/4in (13.3cm).

AU6156

Working length
1-7/8in (4.8cm).



House Mini Forceps

4mm serrated jaws. Overall length
5-1/4in (13.3cm).

AU15317

Working length
2-7/8in (7.2cm).

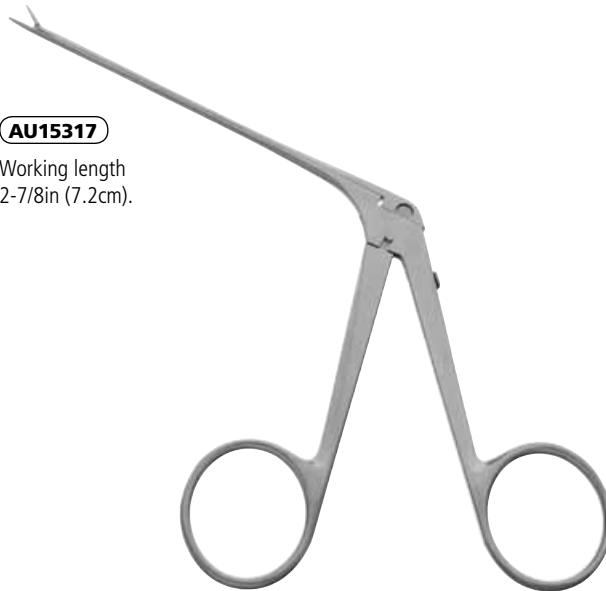

Mini McGEE Forceps

Extra-fine.

AU18205

Overall length
5in (12.7cm).



Ear Forceps

Delicate oval cup, 2mm. Overall length
5-1/4in (13.3cm).

AU18210

Working length
2-7/8in (7.2cm).



HARTMANN Ear Forceps

Serrated, cupped jaws.



AU6150

Extremely delicate.
Working length
2in (5.1cm).



AU6155

Light pattern.
Working length
2-3/8in (6cm).



AU6160

Regular pattern.
Working length
2-3/16in (5.5cm).



NOYES Ear Forceps

Overall length 5-1/8in (13cm).



◆ **AU6180**

Alligator-type.
Fine, delicate,
serrated grasping jaws.



AU6185

1 x 2 teeth with
serrated jaws.

AU6186

6mm serrated
grasping jaws.



WEINGARTNER Ear Forceps

Hawkbill grasping jaws. Serrated at distal end of jaw.

AU6190

Working length
3-1/8in (8cm).



HEERMANN Alligator Ear Forceps

Extremely delicate. Straight jaws.



AU12700

Working length
4-5/8in (11.7cm).

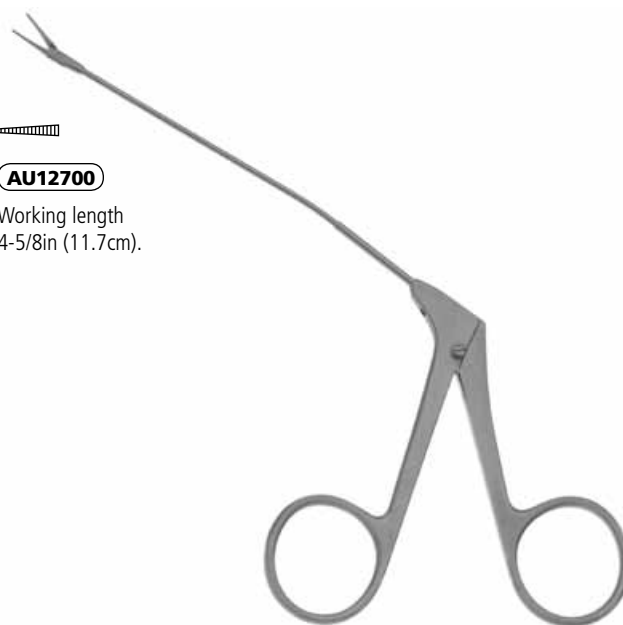

Forceps

Forceps
Zangen
Pinze
Fórceps
Fórceps
鉗子

WULLSTEIN Ear Forceps

Working length 3-1/8in (7.9cm).



◆ **AU14120**

Fine, delicate, serrated jaws.

AU14120H

Heavy, serrated jaws.



◆ **AU14122**

Fine, delicate,
cup-shaped jaws.
0.9mm x 4.5mm
oval cup.



HOUSE Strut Forceps

Fine, smooth jaws.



◆ **AU15300**

Working length
3-1/8in (7.9cm).



HOUSE Alligator Forceps

Fine, serrated jaws open horizontally to right.



◆ **AU15315**

Working length
3-1/8in (7.9cm).



HOUSE Alligator Grasping Forceps

Delicate, serrated. Jaws 0.5cm.



◆ **AU15316**

Working length
3-1/8in (7.9cm).



WULLSTEIN Type Tympanoplasty Forceps

Fine, oval cup-shaped jaws. Working length 2-3/4in (7cm).

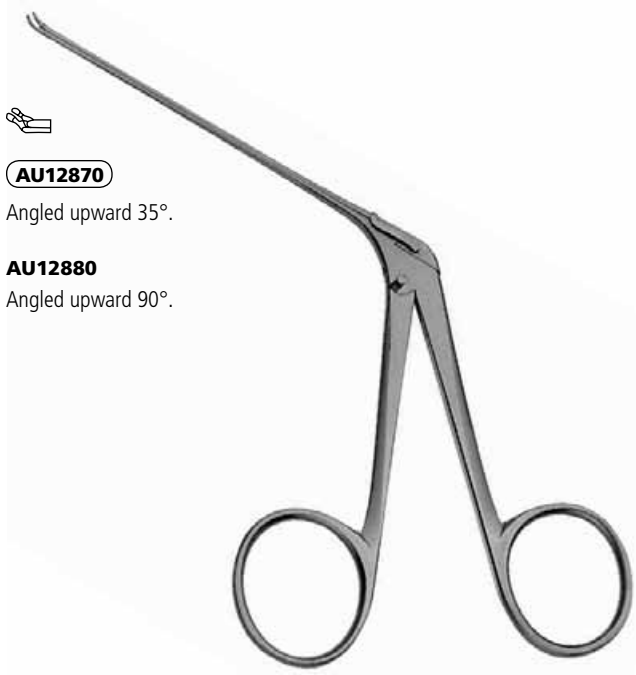

AU12870

Angled upward 35°.

AU12880

Angled upward 90°.

HOUSE Cup Forceps

Delicate oval cup jaws, 2.7mm.



AU14125

Working length
2-7/8in (7.3cm).

HOUGH Alligator Forceps

Delicate, serrated side-grasping jaws.
Working length 3-1/8in (7.9cm).

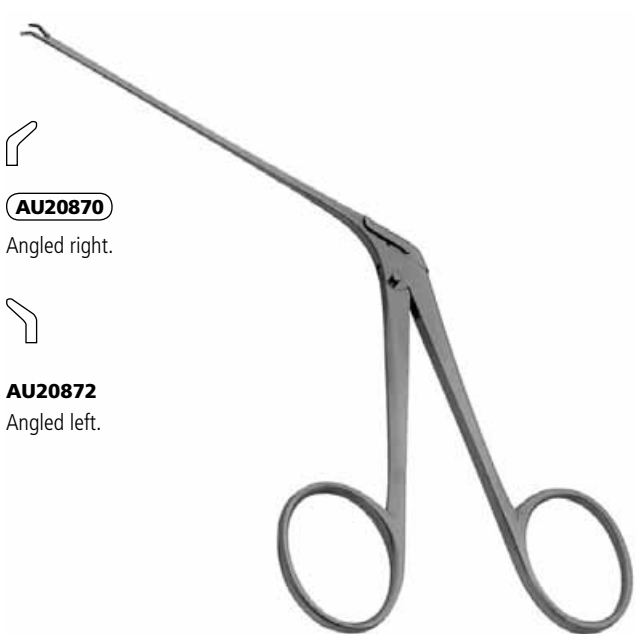

AU20870

Angled right.



AU20872

Angled left.

Cup Forceps

Working length 4in (10cm).



AU6211

Cup 1mm.



AU6212

Cup 2mm.



AU6213

Cup 3mm.

Forceps

Forceps
Zangen
Pinze
Fórceps
Fórceps
鉗子

HARTMANN-CITELLI Ear Punch Forceps

Round, cup-shaped jaws. Working length 3-1/8in (8cm).

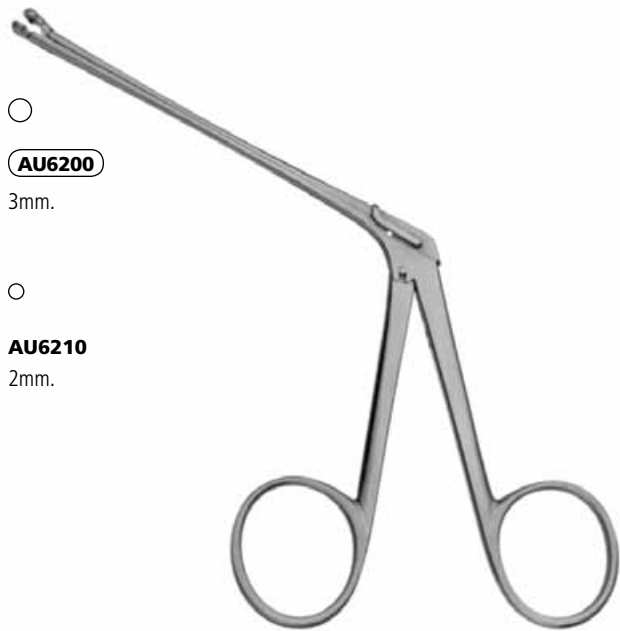

AU6200

3mm.

AU6210

2mm.

STRUEMPEL Ear Punch Forceps

Fenestrated oval cup jaws, 7mm.



AU6220

Working length 3in (7.6cm).

HOUSE-WULLSTEIN Oval Cup Forceps

Working length 3-3/16in (8.1cm).

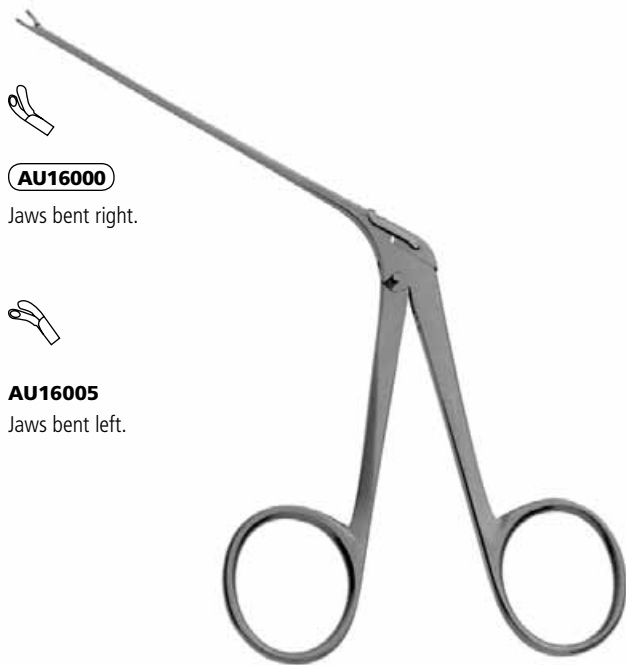

AU16000

Jaws bent right.

AU16005

Jaws bent left.

HOFFMANN Ear Forceps

Punch action. Cup 2mm.



AU6230

Working length 2-3/4in (7cm).

HOUSE-BELLUCCI Alligator Scissors

Delicate.



◆ **AU12220**

Working length
3-1/4in (8.3cm).
Overall length
5-1/4in (13.4cm).



BELLUCCI Alligator Scissors

Heavy.



AU12221

Working length
3-1/4in (8.3cm).
Overall length
5-3/8in (13.7cm).



AU12224

Working length
4in (10.2cm).
Overall length
6-1/8in (15.5cm).



HOUSE Alligator Scissors

Extra-delicate.



AU12225

Working length
3-1/4in (8.3cm).
Overall length
5-1/4in (13.4cm).



WULLSTEIN Ear Scissors

Fine blades, length 5mm.
Working length 4-1/2in (11.4cm).

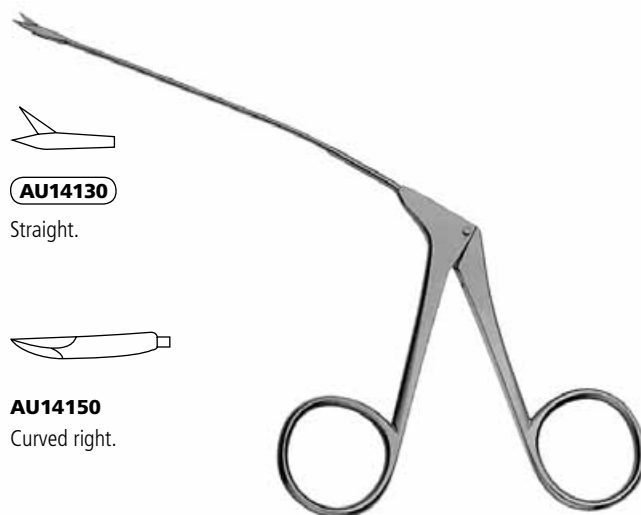

AU14130

Straight.

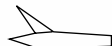

AU14150

Curved right.

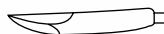

AU14152

Curved left.

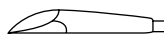

Forceps/Divers
Zangen/Verschiedenes
Pinze/Varie
Fórceps/Varios
Fórceps/Diversos
鉗子/その他

HOUSE-DIETER Malleus Nipper

Delicate jaws.

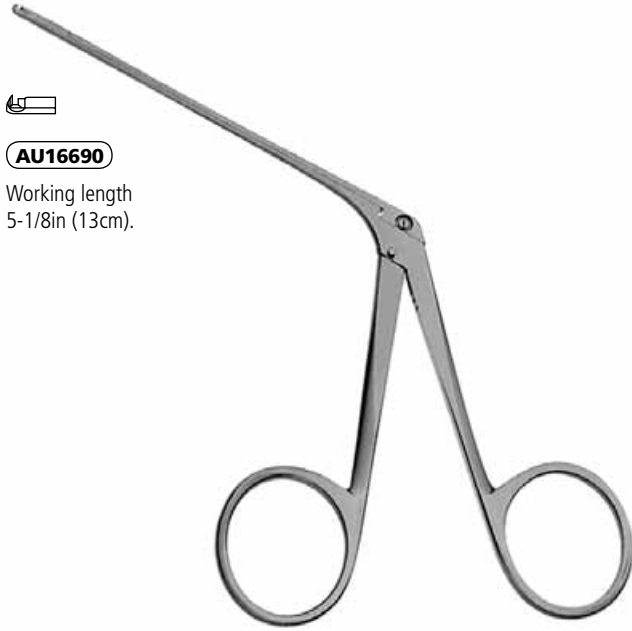

AU16690

Working length
5-1/8in (13cm).

HOUGH Anterior Crurotomy Nipper

Edges of jaws beveled to create miniature bone cutter.
Jaw length 3mm. Angled right.



AU20880

Overall length
5-3/8in (13.6cm).

SCHEER Micro Wire-Crimping Forceps

Smooth jaws, length 5mm.



AU12810

Overall length
5in (12.7cm).

HOUSE Alligator Crimper Forceps

Fine, serrated jaws, length 8mm.

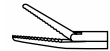

AU15310

Working length 3-1/8in (7.9cm).

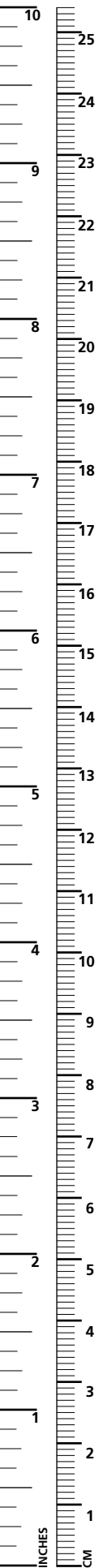

CAPAROSA Wire-Crimping Forceps

Straight, with narrow, grooved jaws.



AU13280

Working length
3-1/8in (7.9cm).



McGEE Wire-Crimping Forceps

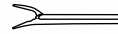

AU18200

Delicate.
Working length
3-1/8in (7.9cm).



GRUPPE Wire Prosthesis-Crimping Forceps

Concave jaws, length 3mm.



AU18260

Working length
3-1/8in (7.9cm).



SCHUKNECHT Wire Crimper

Narrow jaws, length 3mm.



AU19090

Working length
3-1/8in (7.9cm).



Forceps/Miscellaneous

Forceps/Divers
Zangen/Verschiedenes
Pinze/Varie
Fórceps/Varios
Fórceps/Diversos
鉗子/その他

JUERS Crimping Forceps

Delicate. Working length 3-1/8in (7.9cm).

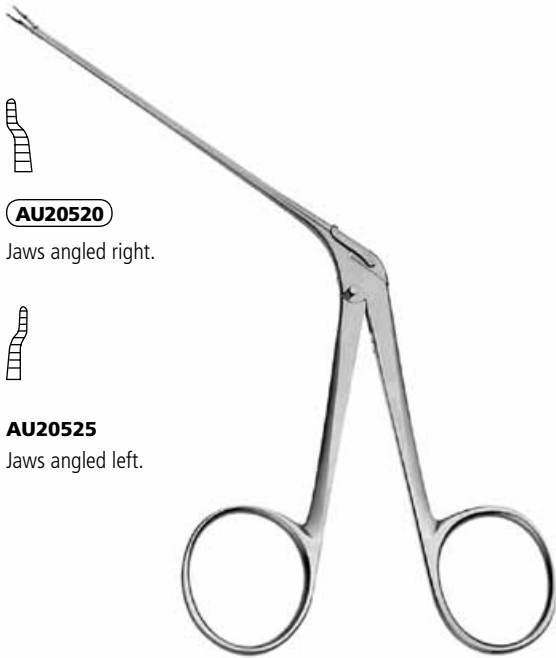

AU20520

Jaws angled right.

AU20525

Jaws angled left.

LEMPERT Malleus Cutter

Jaw length 11mm.

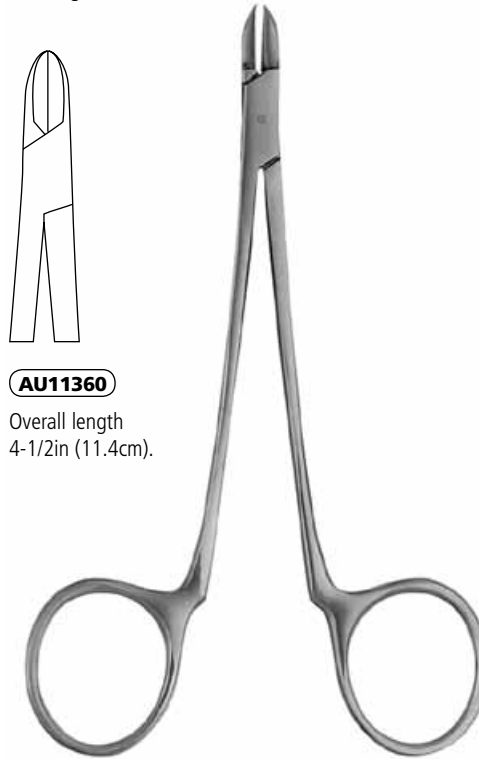

AU11360

Overall length
4-1/2in (11.4cm).

HOUSE Wire Guide



AU15320

Overall length
6-1/2in (16.5cm).

SOFFERMAN Needle Holder

Straight. Overall length 6-3/8 (16.2cm).



AU17210

5mm jaws.

KERRISON Rongeur Forceps

Working length 4in (10.2cm).



AU6769

Extra-small, size 0.
Jaws 3.6mm wide.



AU6770

Small, size 1.
Jaws 4.1mm wide.



AU6771

Medium, size 2.
Jaws 4.5mm wide.



AU6772

Large, size 3.
Jaws 5.0mm wide.

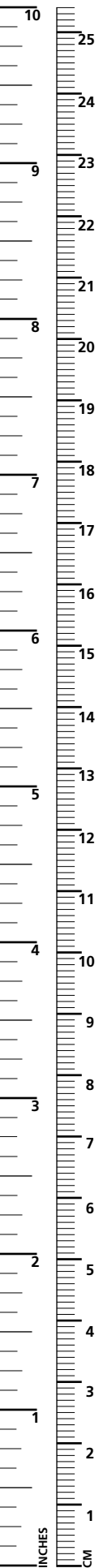

Pinces/Coupe-fils
Zangen/Drahtschneider
Pinze/Tagliafili
Alicates/Cortaalambres
Alicates/Cortadores de fios
ペンチ/ワイヤカッター

BUTLER Forceps

Bayonet-shaped.
Cup-shaped jaws, 1.9mm.



AU12800

Overall length
5-1/2in (13.9cm).



BLAKE Ear Forceps

Small, light, delicate. Angled,
with serrated tips. Mirror finish.



AU6100

Overall length
3-1/2in (8.9cm).



WILDE Ear Forceps

Angled, with serrated tips. Mirror finish.

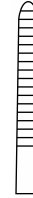

AU6110

Regular size.
Overall length
4-3/8in (11.1cm).

AU6115

Extra-long shanks.
Overall length
5-1/2in (14cm).



LUCAE Ear Forceps

Bayonet-shaped.
Serrated tips.



AU6120

Overall length
5-3/4in (14.6cm).



GRUENWALD Ear Forceps

Bayonet-shaped. Serrated tips.



AU6130

Overall length
6-3/8in (16.2cm).



SHEEHY Ossicle-Holding Forceps

4 x 5 teeth.



AU17215

Overall length
4-3/4in (12.1cm).



Retractors

Écarteurs
Wundspreizer/Retraktoren
Divaricatori
Separadores
Retratores
リトラクター

DERLACKI Ossicle Holder

The tooth and groove arrangement.
Mirror finish.



AU17216

Overall length
4-3/4in (12.1cm).



HOUSE Hand Held Retractor

Double-ended. Blades 20mm x 7mm and
25mm x 9mm wide.

AU17250

Overall length
6in (15.2cm).



SNITMAN Endaural Retractor

3 x 3 sharp prongs. Jaw opening 2in (5.1cm).

AU11030

Overall length
4-3/16in (10.6cm).



WULLSTEIN Retractors

3 x 3 sharp prongs. Angled shanks.

AU14180

Arm length 3-1/8in (8cm).
Overall length
5in (12.7cm).

AU14190

Arm length 2-1/2in (6.4cm).
Overall length
4-1/8in (10.5cm).

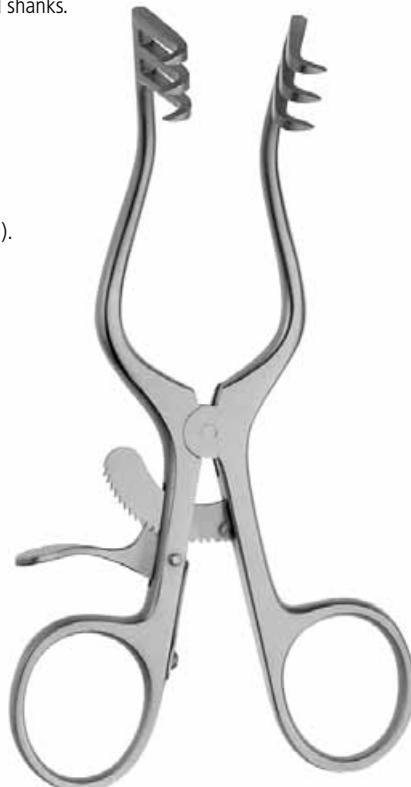

SCHUKNECHT Self-Retaining Postauricular Retractor

3 x 3 sharp prongs. Angled shanks.
Arm length 3in (7.6cm).

AU19270

Overall length
5-1/2in (14cm).

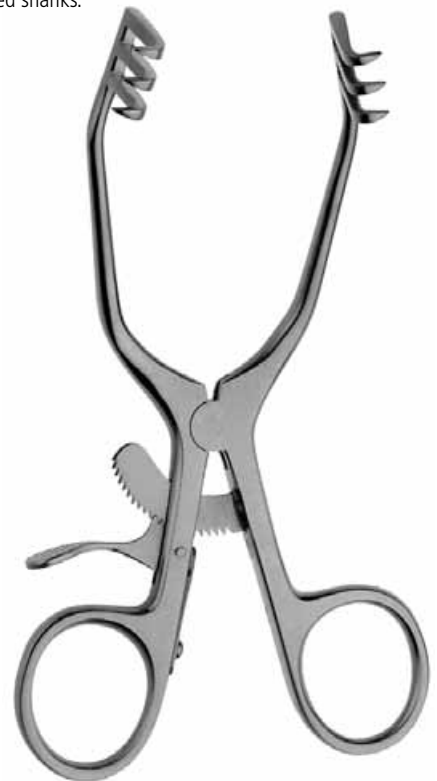

Écarteurs/Ciseaux
Wundspreizer/Retraktoren/Scheren
Divaricatori/Forbici
Separadores/Tijeras
Retradores/Tesoura
リトラクター/鉗

PAPARELLA Retractor

Angled 2 x 2 sharp prongs.

AU13860

Overall length
5in (12.7cm).

**PERKINS Otologic Retractors**

Made right and left. Rake blade is 1/2in x 3/4in (1.3cm x 1.9cm); solid blade, curved and serrated, is 1/2in x 1in (1.3cm x 2.5cm). Total opening 2-1/4in (5.7cm). Overall length 5-1/4in (13.3cm).

AU14192

Right for patient's right.

AU14193

Left for patient's left.

**McCABE Antral Retractor**

Self-retaining, the McCABE retractor contains two center blades and locking ratchet.

RH2650

Large blade is 14.6cm long, 16mm wide, 42mm deep; small blade is 14cm long, 10mm wide and 41mm deep. Overall length 7in (17.8cm).

**WIET Otologic Scissors**

Bayonet-shaped. CASTROVIEJO-style.

AU12227

Straight blades.
Overall length
6-1/2in (16.5cm).

AU12231

Blades angled left, 45°.
Overall length
6-1/4in (15.9cm).



Scissors/Dissectors/Forceps

Ciseaux/Dissecteurs/Forceps
 Scheren/Dissektoren/Zangen
 Forbici/Dissettori/Pinze
 Tijeras/Diseccionadores/Fórceps
 Tesoura/Escafpelos/Fórceps
 鉋/切開器/鉋子

PAPARELLA Wire Cutting Scissors

Angled, serrated blades.
 Mirror finish.



AU13845

Overall length
 4in (10cm).



GUILFORD-SCHUKNECHT Wire-Cutting Scissors

Straight, serrated blades.
 Mirror finish.

AU19180

Overall length
 4in (10.2cm).



HOUSE Scissors

Delicate blades.
 Mirror and Satin finish.

AU17350

Straight.
 Overall length
 6in (15.2cm).

AU17360

Curved.
 Overall length
 5-3/4in (14.6cm).

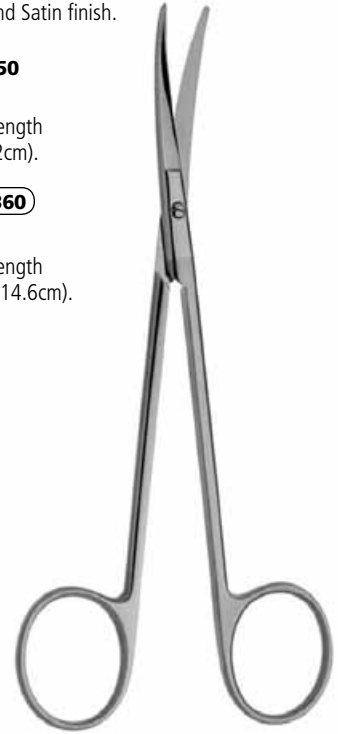

McCABE Dissector

Angled, smooth jaws, length 14mm.



RH1585

Overall length
 5-1/2in (14cm).



NATVIG Wire Twister Forceps



RH2500

Cross-serrated jaws.
 Overall length
 5-3/4in (14.6cm).

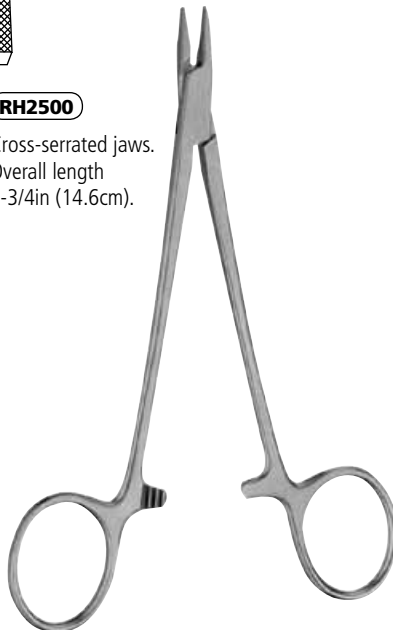

PAPARELLA Tissue Press

None

AU13855



Forceps/Divers
Zangen/Verschiedenes
Pinze/Vario
Fórceps/Varios
Fórceps/Diversos
鉗子/その他

HOUSE Gelfoam® Pressure Forceps

Jaw 1/2in x 1/2in
(1.25cm x 1.25cm).

AU16660

Overall length
6-1/4in (15.9cm).



House Cutting Block

Autoclavable.
3in long x 1-1/2in wide x 1/4in high
(7.6cm x 3.8cm x 0.6cm).

AU16683

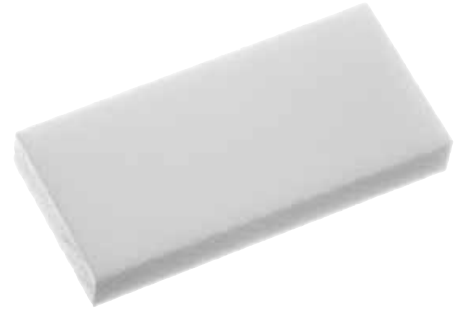

HARTMANN Tuning Forks

Class C. Magnesium-aluminum alloy.

AU5000

C64HZ.

AU5001

C128HZ.

AU5002

C256HZ.

AU5003

C512HZ.

AU5004

C1024HZ.

AU5005

C2048HZ.

AU5006

C4096HZ.

AU5010

Standard set of five tuning forks in durable, compact case. Case is plush lined and covered in black leather. Includes one each of forks C128HZ, C256HZ, C512HZ, C1024HZ and C2048HZ.

AU5011

Case for HARTMANN tuning forks. Durable, compact. Plush lined and covered in black leather. Fitted for five forks.

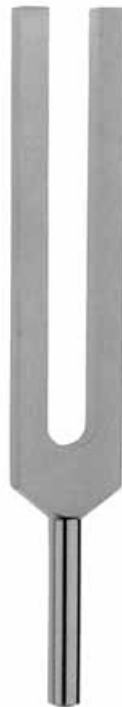

Looking for a specific product?

When you know the catalog number or the name of the product you need, you can use the index at the end of this book to direct you to the page on which the product is described. If you do not find the specific instruments you are looking for, please contact your local V. Mueller sales representative or Customer Support at **800.323.9088**.

Specula

Spéculum
Spekula
Speculum
Espéculos
Espéculos
檢鏡

QUIRE Automatic Finger

AU6140

Overall length
4in (10.2cm).

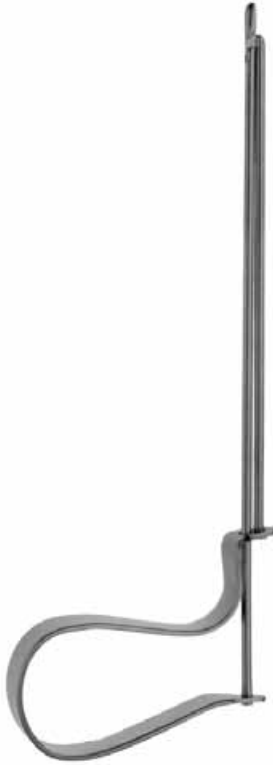

KRAUSE Ear Snare

Complete with one
dozen cut snare wires,
size 00.

AU6280

Overall length
7-3/8in (18.7cm).



Cut Ear Snare Wires

Twelve per package.

AU6307

Size 1.



VIENNA Nasal Specula

Standard pattern. Mirror and Satin finish.

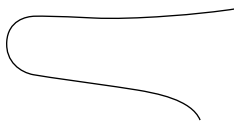

◆ **RH10**

Large. Blade 12.7mm x 32mm.

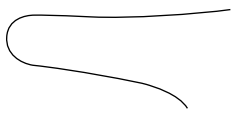

◆ **RH11**

Medium. Blade 11.2mm x 30mm.

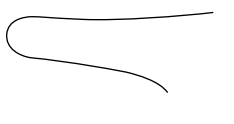

◆ **RH12**

Small. Blade 9.4mm x 27mm.



MERZ-VIENNA Nasal Specula

Light, with delicate spring. Thin blades,
rounded at proximal portion.
Overall length 5-3/8in (13.6cm).

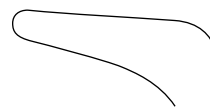

RH13

Small. Blade 27mm x 4.8mm.

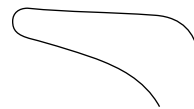

RH14

Medium. Blade 25mm x 6.3mm.

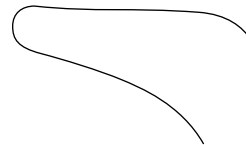

RH15

Large. Blade 32mm x 6.5mm.



LILLIE Nasal Specula

Thin, round blades for maximum field.
Blade 32mm x 3.6mm wide.

RH20

Overall length
5in (13cm).

**HALLE-TIECK Nasal Specula**

Very small size. Blade 17mm x 2.5mm wide.

RH30

Overall length
5-1/8in (13cm).

**SONNENSCHN Nasal Specula**

Medium. Blade 27mm x 5mm wide.

RH41

Overall length
6in (15.2cm).

**BECKMAN-COLVER Nasal Specula**

Blade 27mm x 5.4mm wide.

RH50

Overall length
5-3/4in (14.6cm).

**KILLIAN Nasal Specula**

Overall length 5in (12.5cm).

◆ **RH100**

Blade
85mm x 8.5mm wide.

RH100-1

Blade
75mm x 8mm wide.

RH101

Blade
65mm x 8.7mm wide.

RH102

Blade
50mm x 8mm wide.

**COTTLE Nasal Specula**

A modified KILLIAN speculum with
narrowed, tapering blades 5cm long.
With set screw.

◆ **RH110**

Overall length
5-3/4in (14.6cm).



Specula

Spéculum
Spekula
Speculum
Espéculos
Espéculos
検鏡

COTTLE Specula

Overall length 5-1/8in (13cm).

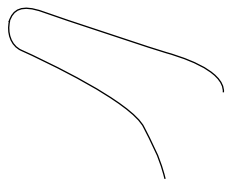

RH111

Short 30mm blades taper from 4mm to 9mm wide.

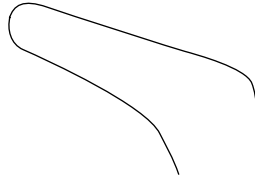

RH112

Short 35mm blades taper from 8mm to 10mm wide.

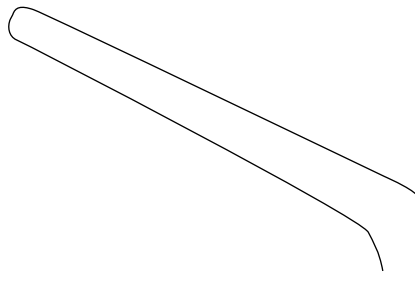

RH113

Medium 60mm narrow blades taper from 5mm to 9mm wide.

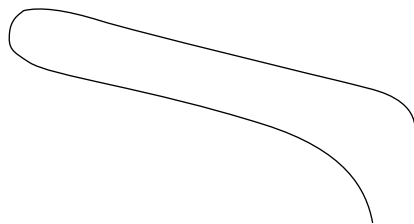

RH114

Medium 55mm blades taper from 8mm to 10mm wide.

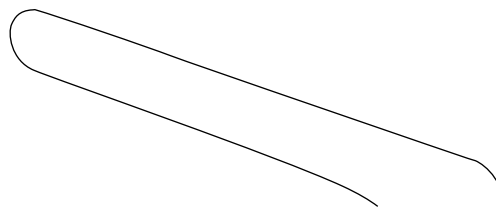

RH115

Medium-long 70mm blades taper from 8mm to 10mm wide.

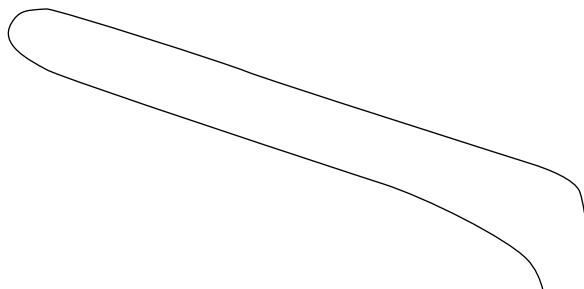

RH116

Long 80mm blades taper from 8mm to 10mm wide.

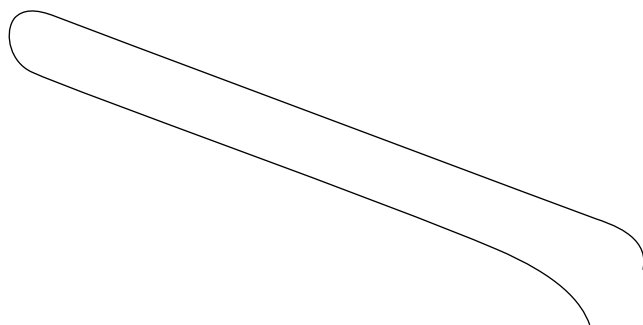

RH117

Extra-long 90mm blades taper from 8mm to 10mm wide.



**LATHBURY (UEBE)
Cotton Applicators**

Nickel-silver alloy. Overall length 7in (17.8cm).



RH198

Triangular tip.
Light pattern.



RH200

Triangular tip.
Regular pattern.



RH205

Twisted tip.
Light pattern.



RH210

Twisted tip.
Regular pattern.

ANDREWS Cotton Applicators

Twisted tip.



RH220

Overall length 5-1/2in (14cm).

LEJEUNE Cotton Applicator

Very thin shank, twisted tip.



RH225

Overall length 5-1/2in (14cm).

**UNIVERSITY OF IOWA
Cotton Applicator**

Flat, partially serrated tip.
Aluminum handle.
Nickel-silver alloy.



RH240

Overall length 6in (15.2cm).

ARBUCKLE Sinus Probe

Delicate, malleable. Silver.

RH300

Overall length 6in (15.2cm).

THEOBALD Sinus Probe

Flat handle. Silver Plated.

RH310

Working length 7in (17.8cm).



Probes/Hooks

Sondes/Crochets
Sonden/Haken
Sonde/Uncini
Sondas/Ganchos
Sondas/Ganchos
プローブ/フック

ARBUCKLE Sinus Probe

Delicate, malleable. Silver Plated.

RH330

Working length 8in (20.3cm).



Nasal Tenacula

Mirror and Satin finish.

RH1140

Set of 5. Includes one each of the following:

◆ **RH1115**

Single sharp hook, 5.8mm diameter.
Overall length
6in (15.2cm).

◆ **RH1120**

Double hook, 2mm between sharp prongs.
Overall length
6in (15.2cm).

◆ **RH1125**

Double hook, 5mm between sharp prongs.
Overall length
6-3/8in (16.2cm).

◆ **RH1130**

Double hook, 7mm between sharp prongs.
Overall length
6-3/8in (16.2cm).

◆ **RH1135**

Double hook, 10mm between sharp prongs.
Overall length
6-3/8in (16.2cm).



Single Prong Micro Hooks

Overall length 5-5/8in (14.3cm).



RH1145-001

Small. Sharp tip, 1mm.



RH1145-002

Large. Sharp tip, 2mm.



RH1145-003

Large. Blunt tip, 2mm.



Double Prong Micro Hooks

Overall length 5-5/8in (14.3cm).



◆ **RH1145-004**

Sharp, 2mm
between tips.

RH1145-008

Blunt, 2mm
between tips.



◆ **RH1145-005**

Sharp, 5mm
between tips.

RH1145-009

Blunt, 5mm
between tips.



RH1145-006

Sharp, 7mm
between tips.

RH1145-010

Blunt, 7mm
between tips.

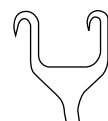

RH1145-007

Sharp, 10mm
between tips.

RH1145-011

Blunt, 10mm
between tips.



Triple Prong Micro Hooks

Overall length 5-5/8in (14.3cm).



RH1145-012

Sharp, 3mm between outer tips.



RH1145-013

Sharp, 6mm between outer tips.



RH1145-016

Blunt, 6mm between outer tips.



STRAIGHT'S Single Tenaculum

Sharp.



◆ **RH1100**

Overall length
5-3/8in (13.6cm).



CONVERSE Skin Hooks

Overall length 7in (17.8cm).



RH1101

No. 1. Hook diameter 1.8mm.



RH1102

No. 2. Hook diameter 2.5mm.



RH1103

No. 3. Hook diameter 3.4mm.



KLEINERT-KUTZ Skin Hooks

Overall length 6-3/8in (16.2cm).



RH1104

No. 1. Hook diameter 2.5mm.



RH1105

No. 2. Hook diameter 4.2mm.



RH1106

No. 3. Hook diameter 4.8mm.



Hooks

Crochets
Haken
Uncini
Ganchos
Ganchos
フック

COTTLE Sharp Tenaculum

Angled.



RH1110

Overall length
5-3/8in (13.6cm).



COTTLE Double Hook

3mm between prongs.



RH1121

Overall length
6in (15.2cm).



GILLIES Skin Hook

Overall length 7in (17.8cm).

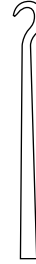

RH2636

Small. Hook diameter 3mm.



RH2637

Large. Hook diameter 4mm.



GILLIES-DINGMAN Hook



RH2734

Overall length
7-3/8in (18.7cm).



BARSKY Skin Hook

Double hook.



RH1108

Overall length
6in (15.2cm).



NEIVERT Nasal Polyp Hook

Bayonet shaft. Mirror and Satin finish.

RH1260

Overall length
7in (17.8cm).

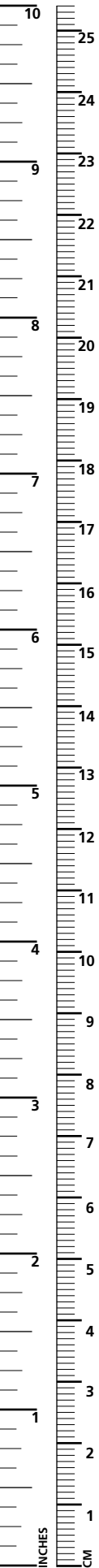

COTTLE Retractors

11mm between two prongs.
Overall length 6in (15.2cm).

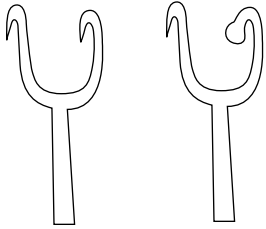

RH1170

Sharp prongs.

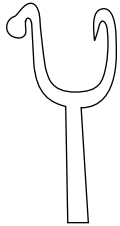

RH1171

Sharp prong on right with prongs up; blunt on left.

RH1172

Sharp prong on left with prongs up; blunt on right.



COTTLE-NEIVERT Retractor

Double-ended. Blades 12mm and 7mm wide. 9mm between blunt prongs, other end with rounded edges.

RH1211

Overall length 8-5/8in (21.9cm).



NEIVERT Retractor

Double-ended.
Blades 15mm and 3.2mm wide.

RH1200

Overall length 7in (17.8cm).



NEIVERT Retractor

Double-ended. Blades 12mm and 3.8mm wide. 9mm between blunt prongs.

RH1210

Overall length 8-1/2in (21.8cm).



Three Prong Retractor

Sharp prongs, flexible shank.

RH1160

Overall length 6-1/4in (15.9cm).



PECK Rake Retractor

Four sharp prongs. Jaw tip 8mm wide. Mirror and Satin finish.

RH1165

Overall length 5-3/8in (13.6cm).



Retractors

Écarteurs
Wundspreizer/Retraktoren
Divaricatori
Separadores
Retradores
リトラクター

FOMON Nostril Elevator-Retractor

13mm between ball-tipped prongs.
Mirror and Satin finish.

RH1190

Overall length
6-1/2in (16.5cm).



COTTLE Four Prong Retractor

Blunt prongs, 2mm wide.

RH1220

Overall length
6-1/2in (16.5cm).



LUONGO Hand Retractors

Mirror and Satin finish.

RH4130

Two blunt prongs. Overall length
6in (15.2cm).

RH4135

Three blunt prongs. Overall length
6-1/2in (15.2cm).



CONVERSE Alar Retractor

Double-ended, 12mm and 14mm wide ends.

RH1175

Overall length
4-1/2in (11.4cm).



LUER "S" Retractor

Double-ended, 6mm and 15mm wide ends.

RH1176

Overall length
5-3/4in (14.6cm).



CONVERSE Blade Retractors

Overall length 3-1/2in (8.9cm).

RH1281

Blade size 1,
19mm x 8.8mm wide.

RH1282

Blade size 2,
30mm x 13mm wide.

RH1283

Blade size 3,
43mm x 13mm wide.

RH1284

Blade size 4,
55mm x 13mm wide.

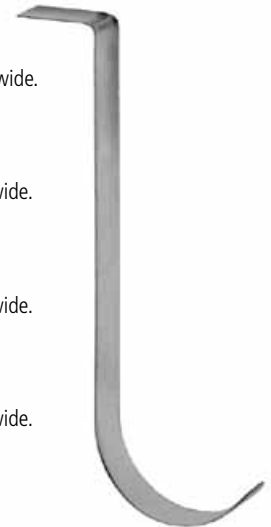

Écarteurs
Wundspreizer/Retraktoren
Divaricatori
Separadores
Retradores
リトラクター

CONVERSE Nasal Retractor

Blade 44mm x 11mm wide.

RH1285

Overall length
4-1/2in (11.4cm).



COTTLE Upper Lateral Exposing Retractor

RH1831

Overall length
6-1/4in (16cm).



DINGMAN FLEXSTEEL Retractor

Malleable.

RH2730

7in x 1/2in (17.8cm x 1.3cm) wide.



Looking for a specific product?

When you know the catalog number or the name of the product you need, you can use the index at the end of this book to direct you to the page on which the product is described. If you do not find the specific instruments you are looking for, please contact your local V. Mueller sales representative or Customer Support at **800.323.9088**.

SALINGER Reduction Instrument

RH1270

Overall length
5-3/4in (14.5cm).



AUFRICHT Retractor-Speculum

Blade 50mm x 13mm wide.

RH1280

Overall length
7-1/2in (18.9cm).



Retractors

Écarteurs
Wundspreizer/Retraktoren
Divaricatori
Separadores
Retratores
リトラクター

FERRIS SMITH-SEWALL Orbital Retractors

Overall length
6-1/4in (15.9cm).

RH4110

Large size.
Slotted blade
6.9cm long x 1.3cm wide.

RH4111

Medium size.
Slotted blade
5.3cm long x 1.2cm wide.

RH4112

Small size.
Slotted blade
3.9cm long x 1.1cm wide.

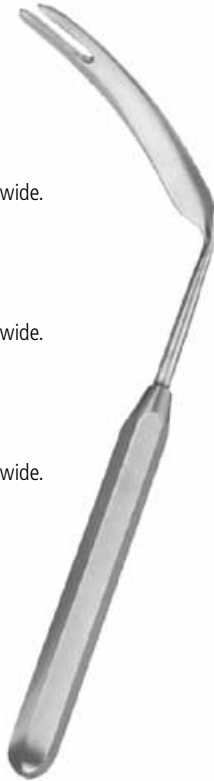

DAVIS Retractor

Double-ended, with slightly lipped blades for support. Blades (19mm x 9mm wide and 23mm x 6.4mm wide).

MO420

Overall length
6in (15.2cm).



PIERCE Cheek Retractor

Blade 1-3/8in x 1in (3.6cm x 2.5cm) wide.
Chrome Plated.

RH4160

Overall length
6-1/4in (15.9cm).



LOVE Nasopharyngeal Retractors

Reinforced angle.

RH4579

Extra-small, 18mm wide.
Working length 3-5/8in (9.2cm).

RH4580

Infant, 20mm wide.
Working length 3-5/8in (9.2cm).

RH4581

Small, 22mm wide.
Working length 4in (10.1cm).

RH4582

Medium, 25mm wide.
Working length 4in (10.1cm).



LATROBE Soft Palate Retractor

RH4590

Working length 5-1/2in (14cm).



Écarteurs/Ciseaux
Wundspreizer/Retraktoren/Scheren
Divaricatori/Forbici
Separadores/Tijeras
Retradores/Tesoura
リトラクター/鉋

BROWN Uvula Retractor

RH4610

Overall length
8-1/2in (21.6cm).



Microsurgery Scissors

Round handle. Overall length 6in (15.2cm).

RH1590

Straight blades,
13mm from screw.

RH1592

Curved blades,
12mm from screw.



JOSEPH Scissors

Sharp/Sharp. Blades 3.5cm from mid-screw.
Mirror finish. Overall length 5in (14cm).

RH1620

Straight.

RH1620-001

Straight. Serrated edges.

RH1630

Curved.

RH1630-001

Curved. Serrated edges.



PECK-JOSEPH Scissors

Blades 4.9cm from mid-screw. Mirror finish.
Overall length 5-1/2in (14cm).

RH1635

Straight.
Sharp/Sharp.

RH1635-002

Straight.
Blunt/Blunt.



RH1635-001

Curved.
Sharp/Sharp.

RH1635-003

Curved.
Blunt/Blunt.



FOMON Saber-Back Scissors

Serrated, curved blades. Mirror finish.

RH1670

Overall length
5in (12.7cm).



Scissors

Ciseaux
Scheren
Forbici
Tijeras
Tesoura
鋏

FOMON Upper Lateral Scissors

Fully curved blades. Mirror finish.

RH1680

Overall length
5-1/4in (13.5cm).



Super Cut FOMON Lateral Scissors

Delicate. Angled. Blunt/Blunt. One serrated blade. Mirror finish.

RH1680-S

Overall length
5-1/4in (13.4cm).



FOMON Angular Scissors

Light pattern, with ground-out blades. Mirror finish.

RH1690

Overall length
5-1/8in (13cm).



Super Cut FOMON Dorsal Scissors

Delicate. Angled. Blunt/Blunt. One serrated blade. Mirror finish.

RH1690-S

Overall length
5-1/2in (14cm).



Vital® FOMON Dorsal Angular Scissors

Angled 30°. Stelliter cutting edges.

RH1691

Overall length
5-1/4in (13.3cm).



COTTLE Angular Scissors

Heavy, rounded blades. Mirror finish.

RH1700

Overall length
6-1/2in (16.5cm).



Super Cut COTTLE Nasal Scissors

Angled. Blunt/Blunt. One serrated blade.
Mirror finish.

RH1700-S

Overall length
6-1/4in (15.9cm).



COTTLE Dressing Scissors

For smoothing stent material.
Curved. Mirror finish.

RH2674

Overall length
5-1/2in (14cm).



RAGNELL Nasal Scissors

Curved.

RH595

Overall length
5-1/4in (13.3cm).



COTTLE Bulldog Scissors

Blunt blades, slightly curved-on-flat.
Mirror finish.

RH1660

Overall length
4-1/2in (11.5cm).



CAPLAN Angular Scissors

Double-action, angled-on-flat, serrated blades.

RH1695

Overall length
7-1/2in (19cm).



Vital® COTTLE Dorsal Angular Scissors

Angled 30°. Blade length 45mm.
Stelliter cutting edges.

RH1699

Overall length
6-1/2in (16.5cm).



Scissors

Ciseaux
Scheren
Forbici
Tijeras
Tesoura
鉋

COTTLE Heavy Septum Scissors

With serrated blade. Angled.
Mirror and Satin finish.

RH1701

Overall length
6-7/8in (17.5cm).



COTTLE Spring Scissors

Straight. Mirror and Satin finish.

RH1702

Overall length
7-1/2in (19cm).



LITTLER Suture-Carrying Scissors

8mm from tips, Mirror finish.

◆ **RH1634**

Overall length
4-3/4in (12cm).



Plastic Utility Scissors

Sharp/Sharp. Blades 3.8cm from

mid-screw. Mirror finish.

Overall length
5in (12.7cm).

RH1600

Straight.

RH1610

Curved.



Super Cut Plastic and Reconstructive Scissors

Curved.

One serrated blade.

Mirror finish.

RH1570-S

Overall length
4-1/2in (11.4cm).

RH1572-S

Overall length
5-1/2in (14cm).



Super Cut Plastic Utility Scissors

Sharp/Sharp. One serrated blade.

Mirror finish.

Overall length
4-3/4in (12cm).

RH1600-S

Straight.

RH1610-S

Curved.



Ciseaux
Scheren
Forbici
Tijeras
Tesoura
鉋

BROPHY GUM SUTURE Scissors

Sharp/Sharp. Overall length
5-1/2in (14cm).

RH1615

Straight.

RH1625

Curved.



FOX-GOLDMAN Scissors

Serrated blades. Tungsten
Carbide inserts.
Overall length
5in (12.7cm).

RH1693

Straight.

RH1694

Curved.



KNIGHT Nasal Scissors

Angled-on-side. Mirror finish.

RH600

Overall length
6-3/4in (17.2cm).



FREEMAN Scissors

Mirror finish.

RH1667

Overall length
7in (17.8cm).



Super Cut FREEMAN-KAYE Scissors

Beveled blades with flat tips.

Blunt/Blunt.
One serrated blade.
Mirror finish.
Overall length
7in (17.8cm).

RH1716-S

Straight.

RH1718-S

Curved.



GORNEY Plastic Surgery Scissors

RH1663

Overall length
7-1/4in (18.4cm).



Scissors

Ciseaux
Scheren
Forbici
Tijeras
Tesoura
鋏

Super Cut GORNEY Plastic Surgery Scissors

Beveled blades.
Blunt/Blunt.
One serrated blade.
Mirror finish.
Overall length
7-1/2in (19cm).

RH1663-S

Straight.

RH1664-S

Curved.



Super Cut GORNEY Platysma Scissors

Beveled blades with
flat tips. Blunt/Blunt.
One serrated blade.
Mirror finish.
Overall length
9in (22.9cm).

RH1560-S

Straight.



SEILER Turbinate Scissors

Heavy pattern.
Angled on side.

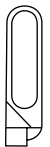

RH612

Overall length
6-1/2in (16.5cm).



GOLDMAN Septum Scissors

Serrated blades. Straight.
Overall length
6in (15.2cm).

RH1692



BECKER Septum Scissors

Serrated blades.
Overall length
6in (15.2cm).

RH1698



Porte-aiguilles
Nadelhalter
Porta-ago
Sostenes de agujas
Porta-agulhas
針ホルダー

NEIVERT Needle Holder



RH2550

Overall length
5in (12.7cm).



Vital® NEIVERT Needle Holder

One offset ring. Tungsten Carbide inserts.
3,600 teeth per square inch.



RH2551

Overall length
5in (12.7cm).



CONVERSE Needle Holder

Light, with longitudinally-serrated jaws. Small.



RH2563

Overall length
4-3/8in (11.1cm).

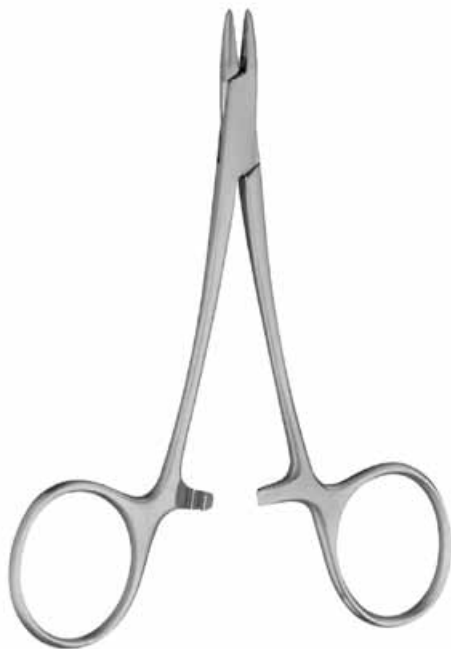

SHEEHAN-GILLIES Needle Holder

Combination needle holder and scissors.
Cross-serrated jaws.

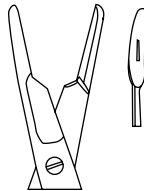

RH2570

Overall length
6-1/8in (15.5cm).



Forceps

Forceps
Zangen
Pinze
Fórcps
Fórcps
鉗子

GRUENWALD Ear Forceps

Bayonet-shaped. Serrated tips.



AU6130

Overall length
6-3/8in (16.2cm).



GRUENWALD Tissue Forceps

Bayonet. 1 x 2 teeth.



RH430

Overall length
6-1/4in (15.9cm).



COHEN Nasal Dressing Forceps

Bayonet. Serrated tips. Mirror finish.



RH460

Overall length
8-1/2in (21.6cm).



BEASLEY-BABCOCK Tissue Forceps

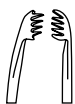

RH2190

Overall length
5in (12.7cm).



CALLISON-ADSON Tissue and Tying Forceps

1 x 2 teeth. Tying platform 5.5mm wide.



RH2195

Overall length
5in (12.7cm).



MUSEHOLDT Nasal Dressing Forceps

Especially slender blades.

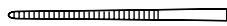
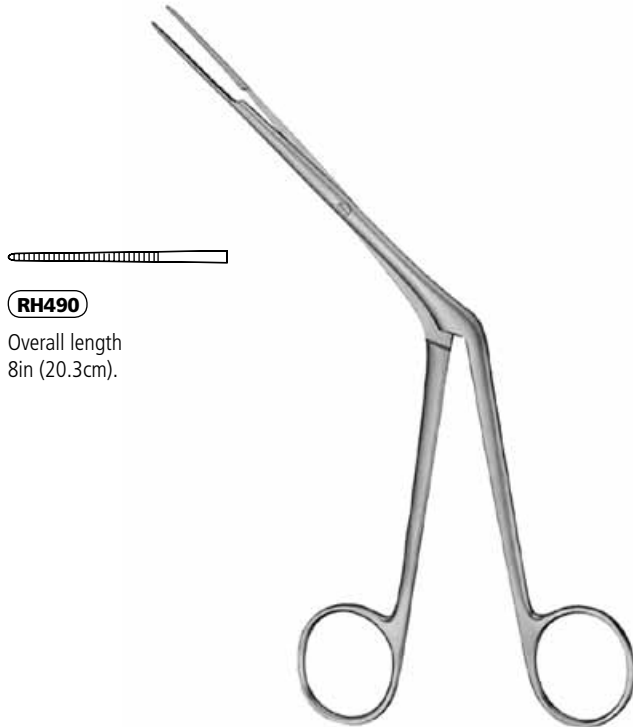

RH490

Overall length
8in (20.3cm).

FISH Nasal Grasping and Dressing Forceps

Alligator-type. Serrated jaws. Jaw length 12mm.

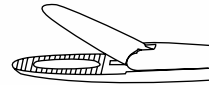

RH530

Overall length
7in (17.8cm).

KNIGHT Turbinate and Polyp Forceps



RH510

Overall length
7in (17.8cm).

WATSON-WILLIAMS Polyp Forceps

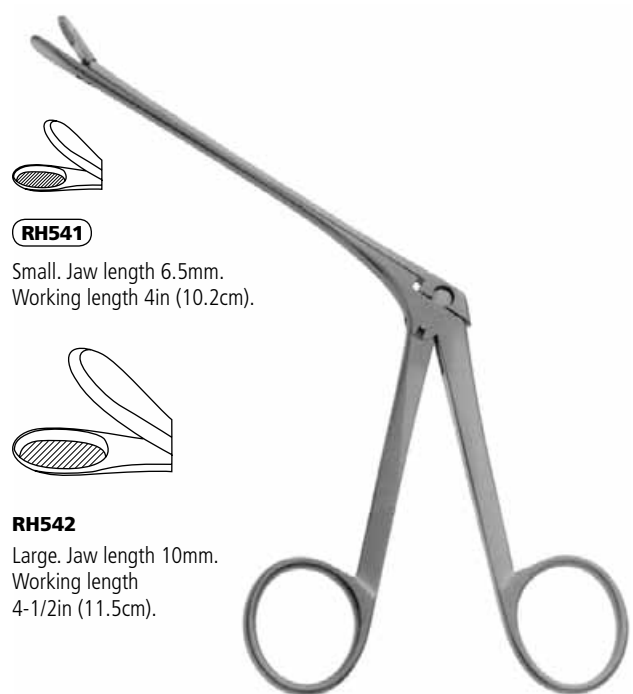

RH541

Small. Jaw length 6.5mm.
Working length 4in (10.2cm).

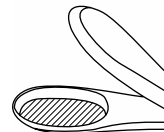

RH542

Large. Jaw length 10mm.
Working length
4-1/2in (11.5cm).

Elevators

Élévateurs
Heber
Elevatori
Elevadores
Elevadores
エレベーター

KRAUSE Nasal Snares

Standard pattern. Durable. Smooth action.

RH650

Complete with angled cannula, wire carrier and 1 snare wire. Working length 4-1/3in (11cm). Overall length 10-1/4in (26cm).

RH651

Cannula only for RH650. Old style with removable screw. Working length 6-1/3in (16.2cm).

RH652-170

Wire carrier only for RH650. For old style set, with removable screw. Working length 5in (12.8cm).



Nasal Snare Wires

Cut and formed.

Packaged by the gross.

RH680-003

3GA. (.012in diameter).

RH680-004

4GA. (.014in diameter).

RH680-005

5GA. (.016in diameter).

RH680-006

6GA. (.018in diameter).



MackENTY Septum Elevator

Flat, curved blade, 4.3mm wide.

RH1000

Overall length 5-3/4in (14.6cm).



HAMRICK Suction Dissector and Elevator

Blunt elevator blade with suction connector and obturator. Tubular, blunt end and fitting to connect with suction apparatus. Matte and Mirror finish.

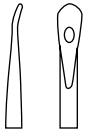

RH850

Overall length 6-3/4in (17.2cm).



COTTLE Elevator-Feelers

Overall length 6-1/4in (15.9cm). Single-ended, graduated.



RH981

Sharp curved blade, 4mm wide.



RH981-002

Sharp curved blade, 2.5mm wide.

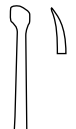

RH981-001

Dull curved blade, 3mm wide.



COTTLE Elevator-Feeler

Double-ended. Graduated in centimeters. Blades 47mm.



RH980

Overall length 9in (22.9cm).



DINGMAN Periosteal Elevator

Double-ended.
Mirror and Satin finish.

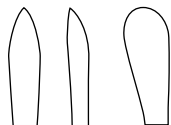

RH2744

Overall length
7in (17.8cm).



FREER Septum Elevator

Double-ended,
sharp and blunt.

◆ **RH750**

Overall length
7-3/4in (19.7cm).



FREER Septum Elevator

Single end, blunt.

RH751

Overall length
7-3/4in (19.6cm).



KLEINERT-KUTZ Elevator and Dissector

Overall length
7-3/4in (19.7cm).

RH723

Double-ended.
Blades 2.5mm and
3.0mm wide.



PROCTOR Mucosa Elevator

Double-ended.
Sharp end angled 100°.
Blunt end angled 90°.
Both blades length 1.2cm.

RH835

Overall length
7in (17.8cm).



COTTLE-MacKENTY Elevator

Double-ended. Curved blades, 5mm wide.

RH1001

Overall length
8-1/2in (22cm).



Elevators/Dissectors

Élévateurs/Dissecteurs
Heber/Dissektoren
Elevatori/Dissettori
Elevadores/Diseccionadores
Elevadores/Escalpelos
エレベーター/切開器

ROGERS Submucous Dissector

Double-ended with right and left curved blades, semi-sharp.

RH800

Overall length
8-3/4in (22.2cm).



PIERCE Submucous Dissector

Double-ended with right and left blades. Spherical style.

RH820

Overall length
7-1/2in (19.1cm).



COTTLE Elevator

Double-ended. Blades 3.2mm.

RH982

Overall length
8-7/8in (22.5cm).



COTTLE Periosteal Elevators

Curved 9mm blade. Overall length
7-1/2in (19.1cm).

RH990

Sharp.

RH991

Dull.



LAMONT Elevator

Slightly curved blade, 4.3mm wide.



RH1030

Overall length
7-3/4in (19.7cm).



GOLDMAN Displacer and Septum Elevator

Tip 6mm wide.

RH1040

Overall length
7-1/2in (19cm).



Élévateurs/Ostéotomes
Heber/Osteotome
Elevatori/Osteotomi
Elevadores/Osteótomos
Elevadores/Osteótomos
エレベーター/骨刀

BOIES Nasal Fracture Elevator

Tip 9mm.

RH1045Overall length
7-1/2in (19.1cm).**DINGMAN Zygoma Elevator**

Heavy, with curved, rounded blade.

RH2742Overall length
8-3/8in (21.3cm).**HAJEK-BALLENGER Septum Elevator and Dissector**

Double-ended. Sharp and blunt blades.

RH790Overall length
7-1/2in (19.1cm).**JOSEPH Periosteotomes**Blade 5mm wide. Overall length
6-1/2in (16.5cm).**RH1010**

Slightly curved blade.

RH1010-001

Straight blade.

**FOMON Periosteotome**

Slightly curved blade, 4mm wide.

RH1020Overall length
6-1/2in (16.5cm).**COTTLE Bone Lever**

Curved. Blade 6.6mm wide.

**RH1431**Overall length
7-1/2in (19.1cm).

○ Instrument pictured

◆ Most widely used patterns

Elevators/Knives/Knife Handles

Élévateurs/Couteaux/Manches de couteau
Heber/Messer/Messergriffe
Elevatori/Bisturi/Impugnatura di bisturi
Elevadores/Cuchillos/Mangos de cuchillos
Elevadores/Facas/Cabos de facas
エレベーター/ナイフ/ナイフハンドル

PENNINGTON Septum Elevator and Dissector

Double-ended.

RH830

Overall length
8-1/4in (21cm).



COTTLE Nasal Knife

Stiff blade with 5.5mm rounded edge.
Mirror and Satin finish.

RH880

Overall length
5-5/8in (14.3cm).



JOSEPH Button-End Knife

Straight with probe point.
32mm x 4.2mm wide.
Mirror and Satin finish.

RH890

Overall length
5-1/2in (14cm).



COTTLE Modified Knife Handle

With dissecting end.
For use with No. 64 blade.

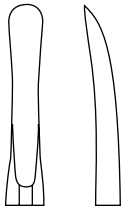

RH855

Overall length
6-1/8in (15.5cm).



COTTLE Double-Edged Knife

Straight with sharp tip.
28mm x 6mm wide.
Mirror and Satin finish.

RH910

Overall length
5-1/2in (14cm).



JOSEPH Double-Edged Knife

Curved with sharp tip.
28mm x 5.5mm wide.

RH920

Overall length
6in (15.2cm).



Couteaux/Manches de couteau
Messer/Messergriffe
Bisturi/Impugnatura di bisturi
Cuchillos/Mangos de cuchillos
Facas/Cabos de facas
ナイフ/ナイフハンドル

FOMON Double-Edged Knife

Curved with blunt tip.
27mm x 6.3mm wide.

RH930

Overall length
5-1/2in (14cm).



COTTLE Nasal Knives

Mirror and Satin finish.

RH936

Complete with replaceable blade,
53mm x 4.7mm wide.
Handle length 6in (15cm).

RH937

Replacement blade only,
53mm x 4.7mm wide.

RH938

Replacement blade only.
Extra-long. 78mm x 4.7mm wide.



COTTLE Protected Knife Handle

No. 3 type for BARD-PARKER No. 15 blades.

RH939

Overall length
5-1/2in (14cm).



FREER Septum Knife

Blade length 5mm. Mirror and Satin finish.

RH720

Overall length
6-1/4in (15.9cm).



BALLENGER Swivel Knives

Straight. Mirror and Satin finish.
Overall length 7-3/4in (19.7cm).

RH760

Blade 5mm wide.



RH761

Blade 4mm wide.

RH762

Blade 3mm wide.



BALLENGER Swivel Knives

Bayonet. Mirror and Satin finish.
Overall length 7-3/4in (19.7cm).

RH765-003

Blade 2mm wide.

RH765-004

Blade 2.5mm wide.

RH765-005

Blade 3mm wide.



Osteotomes

Ostéotomes
Osteotome
Osteotomi
Osteótomos
Osteótomos
骨刀

NEW-LAMBOTTE Osteotomes

Overall length 7-1/2in (19.1cm).

RH1420

5mm wide.

RH1425

7mm wide.

CONVERSE Osteotomes

Straight. Overall length 7in (17.8cm).

RH1445

2mm wide.

RH1446

4mm wide.

RH1447

6mm wide.

RH1448

8mm wide.

RH1449

10mm wide.

RH1450

12mm wide.

Hexagonal-Handle Osteotomes

Overall length 6-1/4in (15.9cm).

RH1465-2

Blade 2mm wide.

RH1465-8

Blade 8mm wide.

RH1465-3

Blade 3mm wide.

RH1465-9

Blade 9mm wide.

RH1465-4

Blade 4mm wide.

RH1465-10

Blade 10mm wide.

RH1465-5

Blade 5mm wide.

RH1465-11

Blade 11mm wide.

RH1465-6

Blade 6mm wide.

RH1465-12

Blade 12mm wide.

RH1465-7

Blade 7mm wide.

PARKES Osteotome

Guarded.
Straight.
Blade 5mm wide.

RH1456

Overall length
6-1/4in (15.9cm).

SILVER Osteotomes

Guarded. Cutting edge 3/16in (5mm).
Overall length 6-7/8in (17.5cm).



RH1462

Straight.



RH1462-001

Curved right.



RH1462-002

Curved left.

CINELLI Osteotomes

Double guards. Overall length
6-1/2in (16.5cm).

RH1464-010

Straight. Blade 10mm wide.

RH1464-014

Straight. Blade 14mm wide.

RH1464-016

Straight. Blade 16mm wide.

RH1464-018

Curved. Blade 10mm wide.

RUBIN Osteotomes

Overall length 6-1/2in (16.5cm).

RH1786

Blade 10mm wide.

RH1788

Blade 14mm wide.



ROWLAND Osteotome

V-shaped cutting edge has blunt 1mm outer tips . 5mm wide.

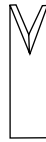

RH1426

Overall length 7-5/8in (19.4cm).



CONVERSE Osteotomes

Guarded. Straight.
Overall length 7-1/2in (19.1cm).

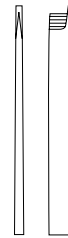

RH1452

Blade 6mm wide.

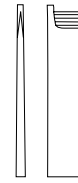

RH1453

Blade 7.5mm wide.



RUBIN Lateral Osteotome

Curved blade.

RH1468

Overall length 6-7/8in (17.5cm).



NEIVERT Osteotome

Guarded. Straight.
Cutting edge 5mm.



RH1495

Overall length 8in (20.3cm).



ANDERSON-NEIVERT Osteotomes

Guarded. Blade 6mm wide.
Overall length 8in (20.3cm).



RH1496

Curved right.



RH1497

Curved left.



Chisels

Ciseaux
Meißel
Scalpelli
Cinceles
Cinzéis
のみ

COTTLE Fishtail Chisel

Protected end. Depth markings.
Blade 16mm wide.

RH1415

Overall length
7-1/4in (18.4cm).



J.H. SHEEHAN Chisels

For the nasal bridge.
Overall length 6in (15.2cm).

RH1440

Blade 7mm wide.

RH1442

Blade 10mm wide.



FREER Submucous Chisels

Tip 5mm wide.
Working length
7-1/2in (19cm).

RH1470

Straight tip.

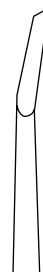

RH1472

Curved tip.



FOMON Chisel

Guarded. One size, 7mm blade.

RH1490

Overall length
6-1/4in (15.9cm).



HAJEK Septum Chisels

V-shaped cutting edge. Overall length 6in (15.2cm).



RH1510

No. 1, small, 4mm.



RH1511

No. 2, medium, 6mm.

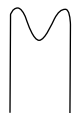

RH1512

No. 3, large, 8mm.



COTTLE Chisel-Osteotomes

Thin blade with depth markings. Overall length
7-1/4in (18.4cm).

RH1400

Blade 4mm wide.

RH1405

Blade 7mm wide.

RH1406

Blade 9mm wide.

RH1410

Blade 12mm wide.



Ciseaux/Jauges
 Meißel/Hohlmeißel
 Scalpelli/Scalpelli cavi
 Cinceles/Gubias
 Cinzéis/Verrumas
 のみ/たがね

COTTLE Crossbar Chisel-Osteotomes

With depth markings. Overall length 7-1/4in (18.4cm).

RH1411

Blade 4mm wide.

RH1412

Blade 7mm wide.

RH1413

Blade 9mm wide.

RH1414

Blade 12mm wide.



CONVERSE Chisels

Guarded. Blade 7.4mm wide. Overall length 7-1/2in (19.1cm).



RH1454

Curved right.



RH1455

Curved left.



PARKES Hump Gouge

Straight. Outside jaw 10mm wide.

RH1457

Overall length
 7in (17.8cm).



COTTLE Chisel

Curved, with depth markings. Blade 6mm wide.

RH1460

Overall length
 7-1/4in (18.4cm).



Bone Cutting Forceps

Pinces coupe-os
Knochensplitterzange
Pinze di taglio ossa
Fórceps de corte del hueso
Pinça para corte ósseo
骨切斷鉗子

BLAKESLEY Septum Bone Cutting Forceps

Round, fenestrated jaws. Alligator-type.



RH2330

Working length 5in (12.7cm).

WILDE Ethmoid Exenteration Forceps

Fenestrated cup-shaped jaws. Working length 4-1/2in (11.5cm).

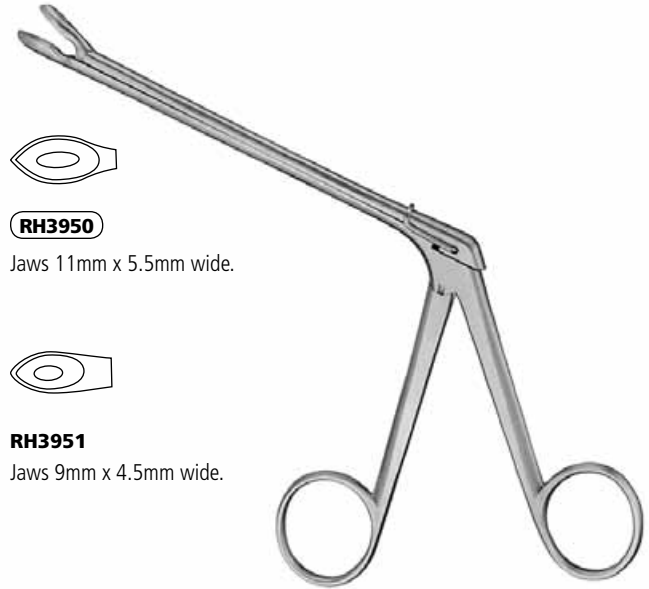

RH3950

Jaws 11mm x 5.5mm wide.

RH3951

Jaws 9mm x 4.5mm wide.

WILDE Ethmoid Forceps

Up-cutting. Cup 10mm x 5mm wide. Fenestrated jaws.



RH3960

Working length 5in (12.5cm).

GRUENWALD-BRYANT Nasal Cutting Forceps

Working length 4-7/8in (12.4cm).

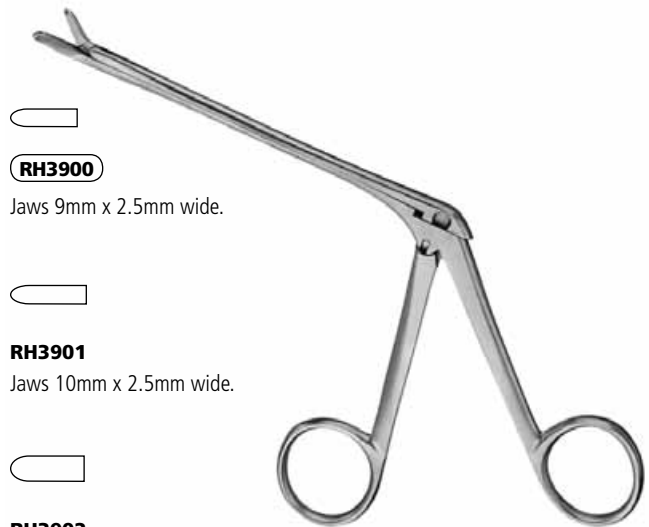

RH3900

Jaws 9mm x 2.5mm wide.

RH3901

Jaws 10mm x 2.5mm wide.

RH3902

Jaws 10mm x 3.5mm wide.

Pinces coupe-os
Knochensplitterzange
Pinze di taglio ossa
Fórceps de corte del hueso
Pinça para corte ósseo
骨切斷鉗子

MYLES Nasal Cutting Forceps

Working length 4-7/8in (12.4cm).

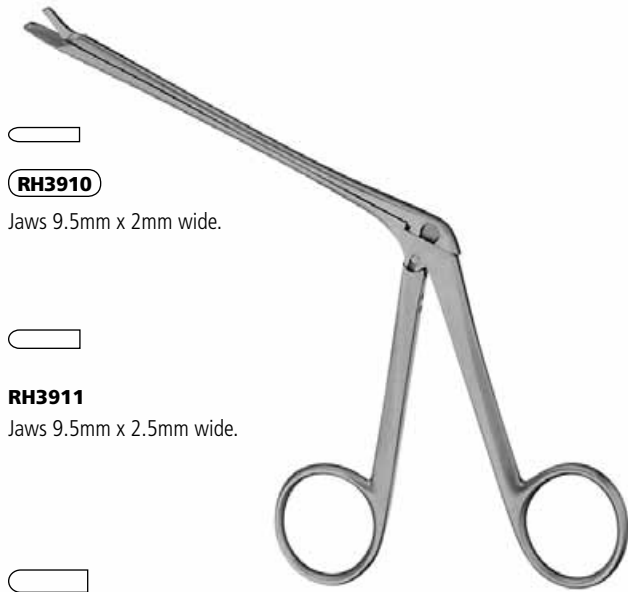

RH3910

Jaws 9.5mm x 2mm wide.



RH3911

Jaws 9.5mm x 2.5mm wide.



RH3912

Jaws 10.5mm x 3mm wide.

BLAKESLEY Nasal Forceps

Fenestrated jaws. Overall length 7-1/8in (18cm).

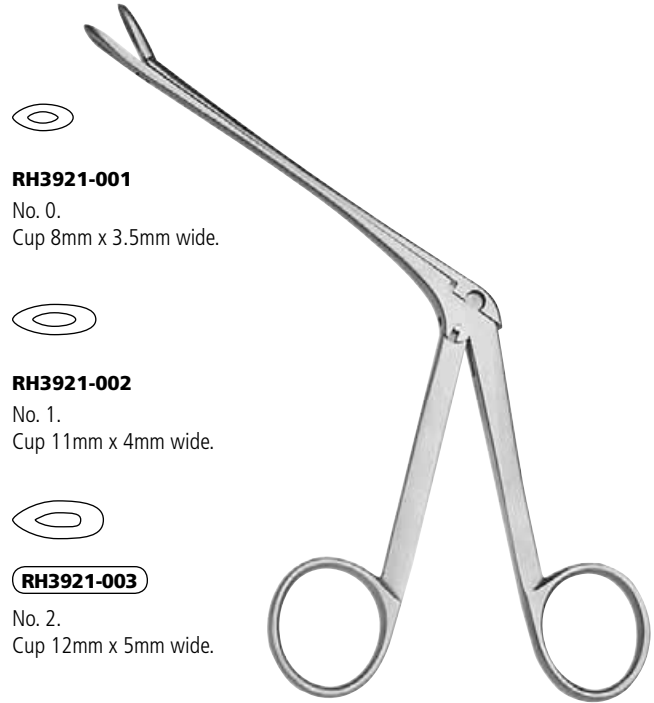

RH3921-001

No. 0.

Cup 8mm x 3.5mm wide.



RH3921-002

No. 1.

Cup 11mm x 4mm wide.



RH3921-003

No. 2.

Cup 12mm x 5mm wide.

BRUENING Ethmoid Exenteration Forceps

Sharp, fenestrated, cup-shaped jaws on mortised shanks. Jaws 5.5mm x 12mm.



RH3980

Working length 2in (4.9cm).

VAN STRUYCKEN Nasal Cutting Forceps

Narrow blade is well adapted to removal of turbinates. Alligator-type.



RH2400

Working length 5in (12.7cm).

Bone Cutting Forceps

Pinces coupe-os
Knochensplitterzange
Pinze di taglio ossa
Fórceps de corte del hueso
Pinça para corte ósseo
骨切斷鉗子

FERRIS SMITH-KERRISON Rongeur Forceps

Bite 5mm. Working length 6-1/4in (15.9cm).



RH4060

Up-cutting.



FERRIS SMITH Bone Biting Forceps

Cup-shaped jaws, 12mm x 5mm wide.



RH4080

Working length 6in (15.2cm).

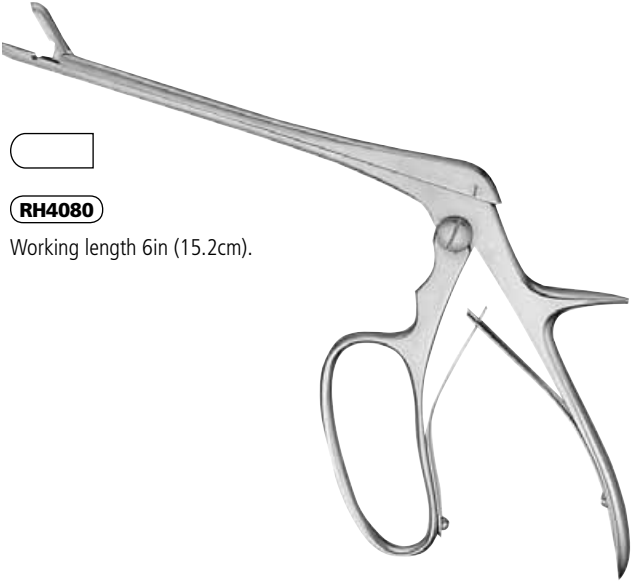

LILLIE-KILLIAN Septum Bone Forceps

Reinforced serrated jaws.



RH2300

Overall length
6-3/4in (17.2cm).

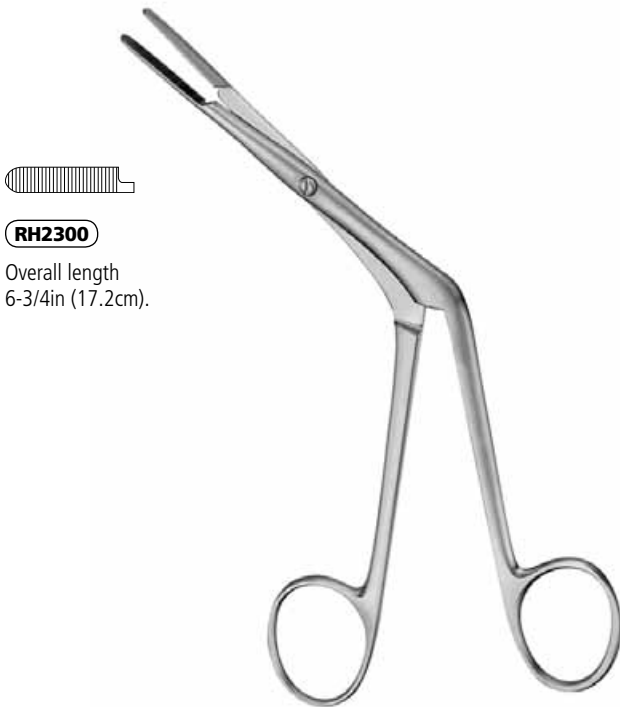

FERRIS SMITH Fragment Forceps

Alligator-type. Fenestrated, serrated jaws, 8.2mm x 6.1mm.



RH2310

Working length
7-3/4in (19.7cm).



Pinces coupe-os
Knochensplitterzange
Pinze di taglio ossa
Fórceps de corte del hueso
Pinça para corte ósseo
骨切斷鉗子

HAJEK-KOFFLER Sphenoid Punch Forceps

Reversible model. Up-cutting jaws. Bite size, 4mm x 3mm.

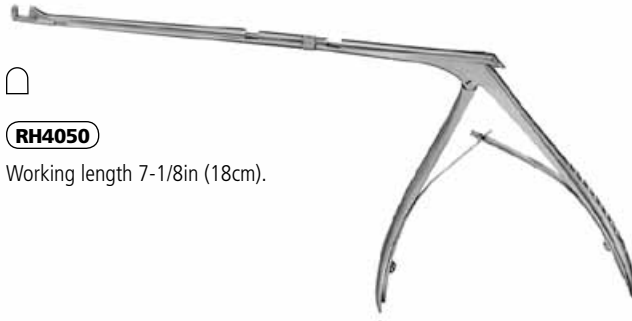

RH4050

Working length 7-1/8in (18cm).

BRUENING Septum Forceps

Mortised shanks. Jaws 9mm x 12mm.



RH2340

Overall length
7-1/4in (18.4cm).



HURD Septum Bone Cutting Forceps

Jaws 18mm x 5.3mm wide.

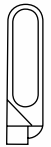
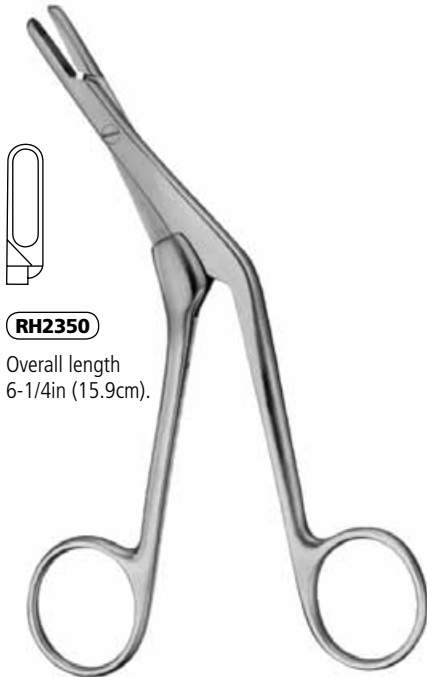

RH2350

Overall length
6-1/4in (15.9cm).

JANSEN-MIDDLETON Septum Forceps

Double-action.
Spoon-shaped blades.



◆ **RH2410**

Overall length
7-1/4in (18.4cm).



JANSEN-STRUYCKEN Septum Forceps

Double-action.
Through-cutting blades.



◆ **RH2420**

Overall length
7-3/4in (19.7cm).

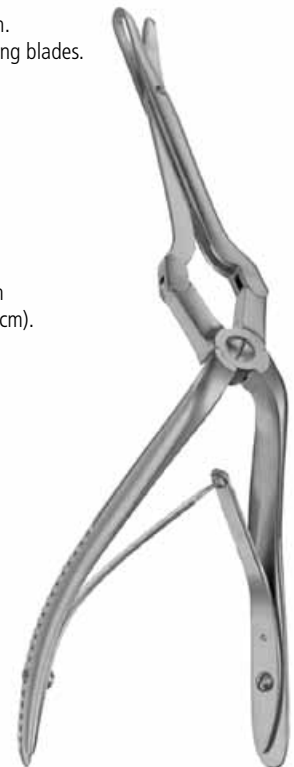

Bone Cutting Forceps

Pinces coupe-os
Knochensplitterzange
Pinze di taglio ossa
Fórceps de corte del hueso
Pinça para corte ósseo
骨切斷鉗子

JANSEN-STRUYSKEN Septum Forceps

Double-action. Light model.
Jaws 19mm x 3.5mm wide.



RH2430

Overall length
7-1/8in (18.1cm).



KAZANJIAN Cutting Forceps

RH1710

Overall length
7-1/2in (19cm).



COTTLE-KAZANJIAN Cutting Forceps

Light model. Fine jaws,
length 1-3/8in (3cm).

RH1720

Overall length
7-1/2in (19cm).



COTTLE Biting Forceps

Angled. Blade length 30mm.

RH1721

Overall length
7-1/8in (18.0cm).



Pinces-gouges/Maillets/Broyeurs d'os
 Rongeur/Schlägel/Knochenbrecher
 Pinze ossivore/Magli/Frangitori di ossa
 Gubias/Mazos/Trituradoras óseas
 Saca-bocados/Malhetes/Trituradores de ossos
 骨鉗子/木槌/脊椎矯正

ROWLAND Hump Forceps

Double-action. Jaw length 1in (2.5cm).



◆ **RH1722**

Overall length
 7-1/2in (19cm).

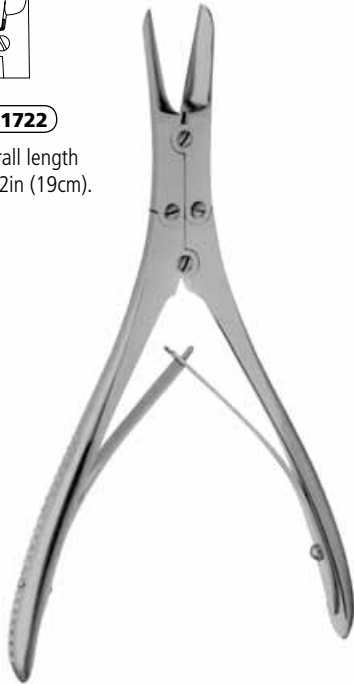

COTTLE-JANSEN Rongeur Forceps

Angled jaws, 12mm x 5mm wide.



◆ **RH1745**

Overall length
 6-3/4in (17cm).



COTTLE Mallet

Face 1-1/8in (2.9cm) diameter.

◆ **RH1540**

Overall length
 8in (20.3cm).



COTTLE Mallets

One flat face of replaceable nylon, one round face. Face 1-1/8in (2.9cm) diameter.

◆ **RH1541**

Overall length
 8in (20.3cm).

RH1542

Nylon face replacement
 for RH1541.



COTTLE Bone Crusher

◆ **RH1545**

Working area 5/8in x 2-3/4in (1.6cm x 7cm).



QUISLING Intra-nasal Hammer

Hollow handle.

◆ **RH1780**

Overall length
 6-3/4in (17.1cm).



Morselizers/Bone Holding Forceps

Broyeurs/Daviers porte-os
 Quetschzangen/Knochenhaltezange
 Sgorbie/Pinze portaossa
 Trituradoras/Fórceps de sostén del hueso
 Goivas/Pinça para fixação óssea
 斷片器/骨固定鉗子

YARMO Morselizer

Cross-serrated Tungsten Carbide inserts.
 Jaws 4.5mm x 3mm wide.

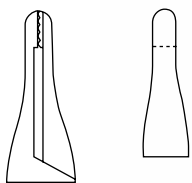

RH1750

Overall length
 7-1/8in (18.1cm).

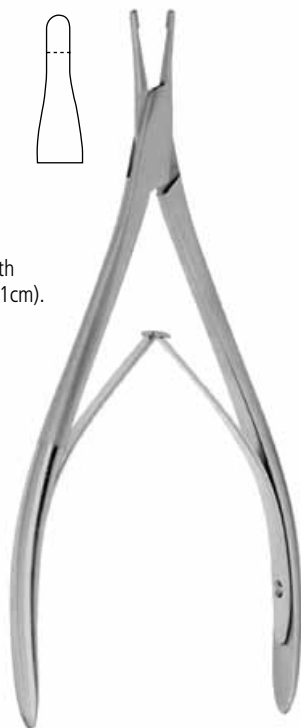

WALSHAM Septum Straighteners

Overall length 9in (22.9cm).

RH1751

Right.

RH1752

Left.

RH1753

Universal.



COTTLE-WALSHAM Septum Straightener

Narrow blades.

RH1760

Overall length
 9in (22.9cm).



ASCH Septum Straightener

Angled.

RH1770

Overall length
 8-3/4in (22.2cm).



RUBIN Morselizer

Jaws 15mm x 5.5mm wide.

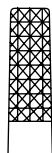

RH1790

Overall length
 10in (25.5cm).



JOSEPH Nasal Saws

Bayonet-type. Blade length 1-1/2in (3.8cm)
 long. Overall length 7-1/4in (18.4cm).

RH1800

Bent to left when teeth
 are up, for patient's right.

RH1801

Bent to right when teeth
 are up, for patient's left.



Scies/Rugines
Sägen/Raspeln
Seghe/Raschietti
Sierras/Raspadores
Serras/Raladores
のこぎり/石目やすり

JOSEPH-MALTZ Nasal Saw

Blade length 1-3/8in (3.5cm) long.
Working length 3-1/4in (8.3cm).

RH1820

Angled for patient's left.

RH1821

Angled for patient's right.

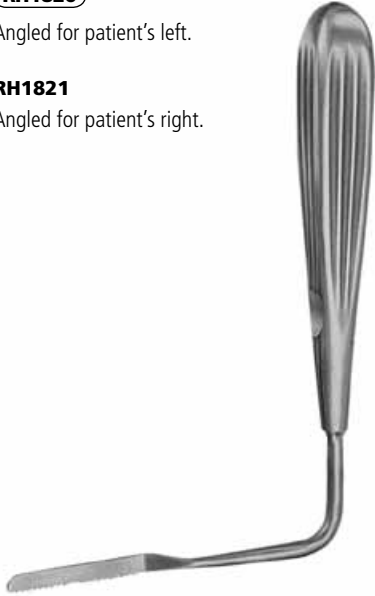

JOSEPH Nasal Saw

Straight. Blade length 1-1/2in (3.8cm).

RH1860

Overall length
7-1/2in (19cm).



SLAUGHTER Nasal Saw

Straight. Blade length 1-1/2in (3.8cm).

RH1861

Overall length
7-1/4in (18.4cm).



COTTLE Alae Protector

RH1830

Overall length
6-1/4in (16cm).



MALTZ Nasal Rasp

For smoothing off bony prominences
after hump removal. Down-cutting.
Blade 35mm x 8mm wide.

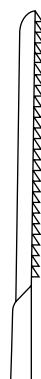

RH2050

Overall length
6-3/4in (17.1cm).



MALTZ-ANDERSON Nasal Rasp

For smoothing off bony prominences
after hump removal. Up-cutting.
Blade 38mm x 5.7mm wide.



RH2055

Overall length
6-1/2in (16.5cm).



Rasps

Rugines
Raspeln
Raschietti
Raspadores
Raladores
石目やすり

ISRAEL Nasal Rasps

Concave, down-cutting.

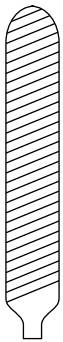

RH2061-006

Blade 40mm x 6.5mm wide.
Overall length
7in (17.8cm).

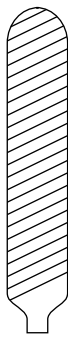

RH2061-008

Blade 40mm x 8mm wide.
Overall length
7in (17.8cm).

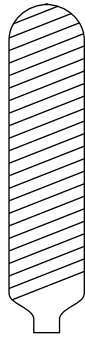

RH2061-010

Blade 41mm x 10mm
wide. Overall length
7-1/8in (18.1cm).

BERNE Nasal Rasp

Concave, down-cutting.
Blade 42mm x 10mm wide.

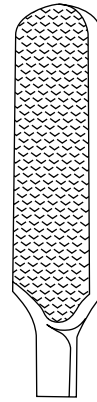

RH2070

Overall length
7in (17.8cm).



GOOD Antrum Rasp

Round and conical rasp for
enlarging opening in all directions.

RH3550

Overall length
6-3/4in (17cm).



Diamond Rasps

Overall length 7-1/4in (18.4cm).

RH2000

Set of four patterns: straight and curved, medium grit;
straight and curved, coarse grit.

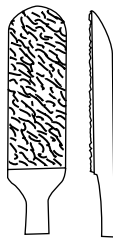

RH2000-3

Straight.
Medium grit.



RH2000-4

Curved.
Medium grit.

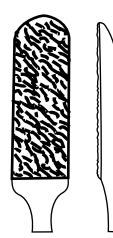

RH2000-5

Straight.
Coarse grit.



RH2000-6

Curved.
Coarse grit.



MALTZ-LIPSETT Nasal Rasp

One-piece construction, heavy handle.
Blade 50mm x 9.7mm wide.

RH2060

Overall length
7-1/2in (19cm).



LEWIS Nasal Rasps

Blade 19mm x 10mm wide.
Overall length 7in (17.8cm).



RH2080

Fine.



RH2081

Coarse.



AUFRICHT Glabellar Rasps

Blade 20mm x 7.3mm wide.
Overall length 7in (17.8cm).



RH2090

Up-cutting.



RH2091

Down-cutting.



PARKES Nasal Rasps

Down-cutting. Blade 34mm x 8mm wide.
Overall length 7-7/8in (20cm).



RH2069

Fine.
20 concave teeth.



RH2069-001

Extra-coarse.
11 concave teeth.



AUFRICHT Nasal Rasps

Curved. Blade 25mm x 9mm wide.
Overall length 8in (20.3cm).



RH2090-001

Up-cutting.



RH2090-002

Down-cutting.



AUFRICHT-LIPSETT Nasal Rasp

Down-cutting. Blade 19mm x 7.2mm wide.



RH2100

Overall length
7-7/8in (20cm).



Rasps

Rugines
Raspeln
Raschietti
Raspadores
Raladores
石目やすり

Double-Ended Rasps

Tungsten Carbide ends. Overall length 8-1/4in (21cm).

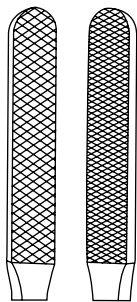

RH2110-001

Grit 1 and 2.

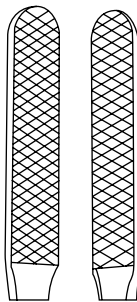

RH2110-003

Grit 3 and 4.

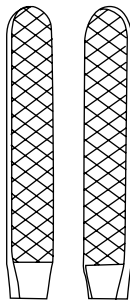

RH2110-005

Grit 5 and 6.

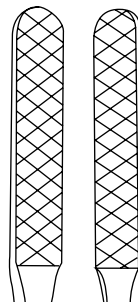

RH2110-007

Grit 7 and 8.



FOMON Nasal Rasps

Down-cutting. Double-ended. Each blade 4.2cm x 0.7cm wide. Overall length 8-1/2in (22cm).

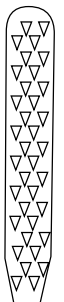
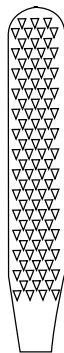

RH2010

Flat, double-sided, with three flat surfaces and one beveled surface.

RH2010-001

Single-sided. Fine teeth.

RH2010-002

Single-sided. Coarse teeth.



Rugines/Trocarts/Curettes
 Raspeln/Trokare/Küretten
 Raschietti/Trocar/Curette
 Raspadores/Trócares/Curetas
 Raladores/Trocânteres/Curetas
 石目やすり/トロカール/キュレット

COTTLE Rasp or Sweeper

Hollow handle. Down-cutting.

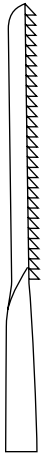

RH2040

Overall length
 8-3/8in (21.3cm).



RUBIN Oblique Rasp

Overall length 8-1/2in (21.6cm).

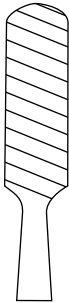

RH2067

Small, down-cutting.
 24mm x 8.4mm wide.



WELLAMINSKI Antrum Perforator

For perforation of lamina papyracea.
 Blade diameter 6mm.

RH3520

Overall length
 6-1/2in (16.5cm).



WIENER-PIERCE Antrum Trocar and Rasp

RH3530

Overall length
 7-3/4in (19.7cm).



RH3580

No. 1.
 Slightly angled oval jaw.
 Overall length
 6-1/2in (16.5cm).



RH3582

No. 3.
 Oval jaw angled 90°.
 Overall length
 5-7/8in (14.9cm).



RH3584

No. 5.
 Oval jaw angled 45°.
 Overall length
 6-3/8in (16.2cm).

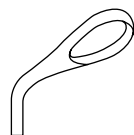

RH3581

No. 2.
 Oval jaw angled 45°.
 Overall length
 6-3/8in (16.2cm).



RH3583

No. 4.
 Straight oval jaw.
 Overall length
 6-1/2in (16.5cm).

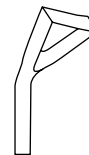

RH3585

No. 6.
 Slightly angled triangular jaw.
 Overall length
 6-1/2in (16.5cm).



Curettes/Needles

Curettes/Aiguilles
Küretten/Nadeln
Curette/Aghi
Curetas/Aguijas
Curetas/Agulhas
キュレット/針

COAKLEY Sinus Curettes

Double-ended.

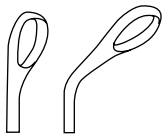

RH3591

Nos. 1 and 2. One straight oval jaw and one oval jaw angled 45°. Overall length 9-5/8in (24.5cm).

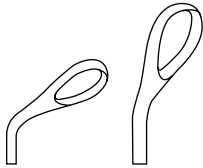

RH3592

Nos. 3 and 4. One oval jaw angled 45° and one slightly angled oval jaw. Overall length 9-7/8in (25.1cm).

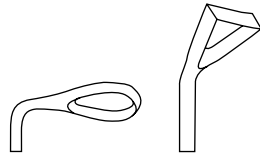

RH3593

Nos. 5 and 6. One oval jaw angled 90° and one slightly curved triangular jaw. Overall length 9-5/16in (23.7cm).



PRATT Ethmoid Curette

Double-ended. One solid cup and one fenestrated cup, 6mm diameter.

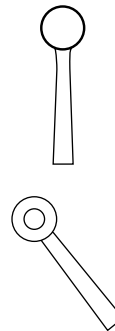

RH3640

Overall length 8-1/4in (21cm).



LICHTWICZ Antrum Needle

16GA. With stylet and cross bar. Luer hub. Mirror finish.

RH2910

Overall length 4-1/8in (10.5cm).



MYERSON Antrum Trocar and Wash Tube

12GA. Luer hub, double curve.

RH2950

Working length 3-1/4in (8.3cm).



RUSKIN Antrum Trocar Needle

Luer hub, curved tip.

RH2960

Overall length 4-1/8in (10.5cm).



Canules/Forceps
Kanülen/Zangen
Cannule/Pinze
Cânulas/Fórceps
Cânulas/Fórceps
カニューレ/鉗子

COAKLEY Antrum Trocar and Wash Tube

13GA at tip, tapers to 19GA. Chrome Plated.

RH2980

Overall length
6in (15.2cm).



VON EICKEN Antrum Wash Tubes

Size 11Fr. Working length 3-1/2in (8.9cm).

RH3060

Overall length
6in (15.2cm).



Antrum and Frontal Sinus Wash Tubes

Malleable. Mirror finish.

Overall length
6-1/4in (15.9cm).

RH3080

Small size, No. 1, 16GA.

RH3081

Medium size, No. 2, 15GA.

RH3082

Large size, No. 3, 14GA.



COTTLE Tissue Forceps

Modified VON GRAEFE forceps with deep teeth.



RH2200

Overall length
4-5/8in (11.7cm).



HINDER Cartilage Forceps

Sharp rat teeth.



RH2201-1

Overall length
5in (12.7cm).



COTTLE Columella Clamp

Jaws 11mm wide.

RH2220

Overall length
4-1/4in (10.8cm).



Forceps/Scissors

Forceps/Ciseaux
Zangen/Scheren
Pinze/Forbici
Fórceps/Tijeras
Fórceps/Tesoura
鉗子/鉗

Cartilage Cutting Board

PVC.

RH2242

Size 3in x 5in x 5/8in (7.6cm x 12.7cm x 1.6cm).



COTTLE Insertion Forceps

Serrated cup jaws, 6mm x 1.5mm wide.



RH2246

Overall length
6-1/4in (15.9cm).



LOVE Nasal Splints

Malleable. T-shaped.

RH2670

Set includes small, medium and large splints.



Adult Nasal Scissors

Serrated blades. Working length 5-1/8in (13cm).

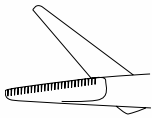
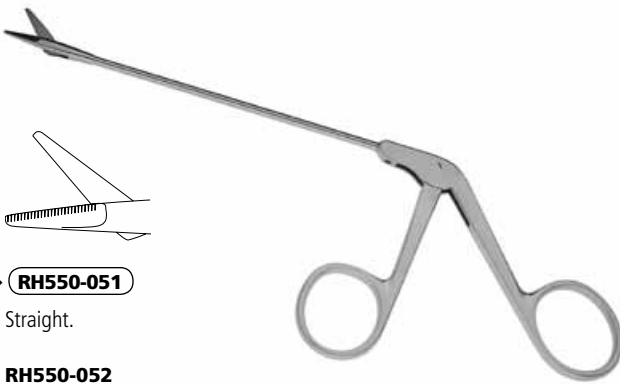

RH550-051

Straight.

RH550-052

Curved right.

RH550-053

Curved left.

Micro Nasal Scissors

Working length 4in (10cm).



RH551-151

Straight.
Blade length 6mm.

RH551-152

Curved right.
Blade length 5.5mm.

RH551-153

Curved left.
Blade length 5.5mm.

TAKAHASHI Nasal Forceps

Overall length 7in (17.8cm).

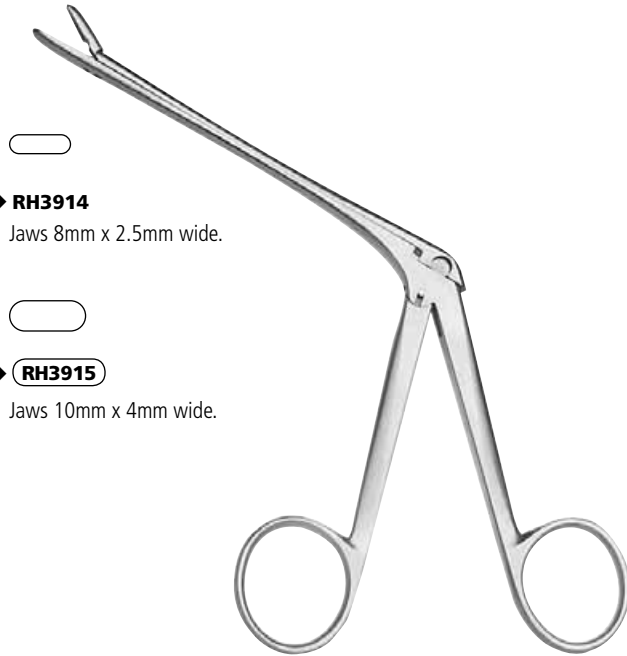

◆ **RH3914**

Jaws 8mm x 2.5mm wide.

◆ **RH3915**

Jaws 10mm x 4mm wide.

TAKAHASHI Nasal Forceps

Working length 4-1/2in (11.5cm).



RH551-651

2.5mm x 8mm cup.



RH551-652

4mm x 10mm cup.

STRUEMPPEL-VOSS Forceps

Oval, fenestrated cup. Working length 4-1/8in (10.5cm).
Cup size 2.4mm.

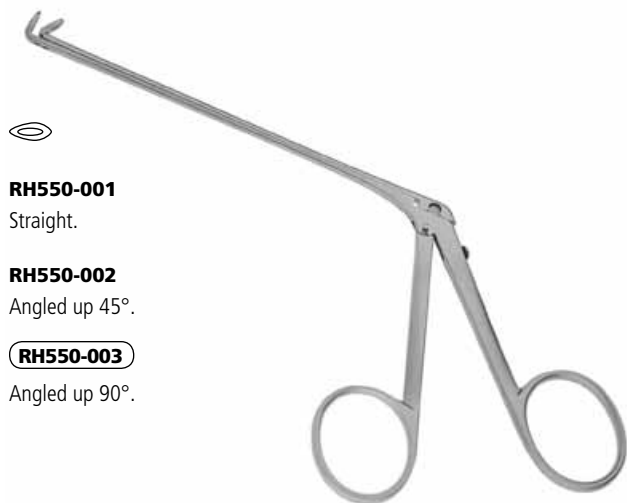

RH550-001

Straight.

RH550-002

Angled up 45°.

RH550-003

Angled up 90°.

BLAKESLEY-WEIL Nasal Forceps

Angled up 90°. Working length 4-1/2in (11.5cm).



RH550-071

3.5mm cup.



RH550-072

4mm cup.



RH550-073

5mm cup.

Forceps

Forceps
Zangen
Pinze
Fórceps
Fórceps
鉗子

BLAKESLEY Nasal Forceps

Up-turned 45°. Overall length 7in (17.8cm).

◆ **RH3922-001**

No. 0. Cup 8mm x 3.5mm wide.

RH3922-002

No. 1. Cup 11mm x 4mm wide.

RH3922-003

No. 2. Cup 12mm x 5mm wide.

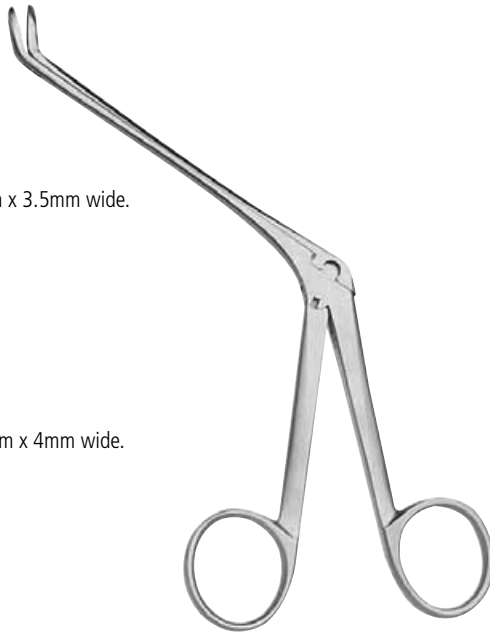

BLAKESLEY-WEIL Forceps

Fenestrated cup 5mm x 2.5mm wide. No. 00.
Working length 4-1/2in (11.5cm).

RH551-111

Straight.

RH551-112

Angled up 45°.

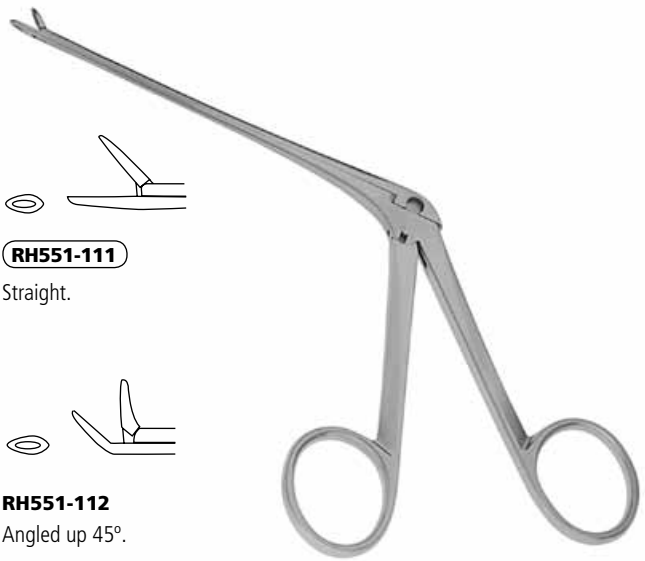

STRYUCKEN Turbinate Forceps

Tips 1.5mm wide.

◆ **RH551-591**

Working length 4-3/4in (12cm).



BLAKESLEY-WEIL Forceps

Working length 4-1/2in (11.5cm).

◆ **RH551-681**

Straight.
No. 0. Tip 3.5mm wide.

RH551-682

Straight.
No. 1. Tip 4mm wide.

RH551-683

Straight.
No. 2. Tip 5mm wide.

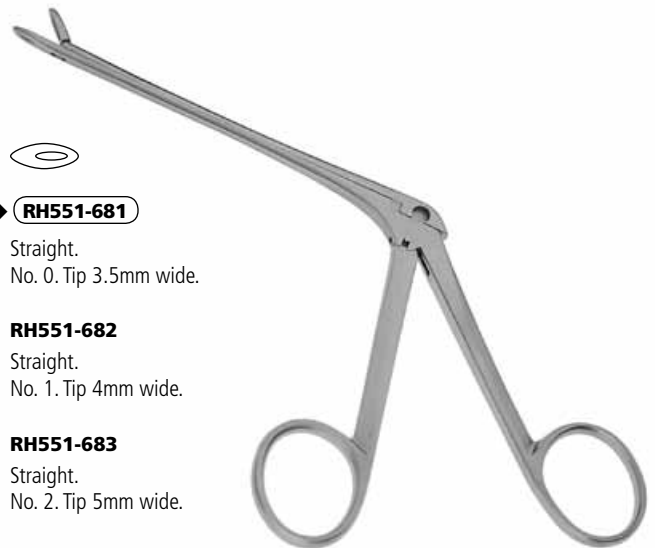

BLAKESLEY Thru-Cut Forceps

Fenestrated. Serrated.



RH551-091

Straight.
No. 00.
Jaw width 2.5mm.
Working length
4-3/4in (12cm).



RH551-093

Straight.
No. 0.
Jaw 3.5mm wide.
Working length
4-3/4in (12cm).



RH551-097

Angled right.
No. 0.
Jaw 3.5mm wide.
Working length
4-3/4in (12cm).

RH551-095

Straight.
No. 1.
Jaw 5mm wide.
Working length
4-3/4in (12cm).

RH551-092

Angled up 45°.
No. 00.
Jaw 2.5mm wide.
Working length
4-3/8in (11cm).

◆ **RH551-094**

Angled up 45°.
No. 0.
Jaw 3.5mm wide.
Working length
4-3/8in (11cm).

RH551-098

Angled left.
No. 0.
Jaw 3.5mm wide.
Working length
4-3/4in (12cm).

RH551-096

Angled up 45°.
No. 1.
Jaw 4mm wide.
Working length
4-3/4in (12cm).

Nasal Suction Forceps

Double-action.



RH551-351

Straight.
No. 00.
Tip 2.5mm wide.
Working length
4-3/4in (12cm).



◆ **RH551-353**

Straight.
No. 0.
Tip 3.5mm wide.
Working length
4-3/4in (12cm).



RH551-355

Straight.
No. 1.
Tip 4.85mm wide.
Working length
4-3/4in (12cm).

RH551-352

Angled up.
No. 00.
Tip 2.5mm wide.
Working length
4-3/8in (11cm).

RH551-354

Angled up.
No. 0.
Tip 3.5mm wide.
Working length
4-3/8in (11cm).

RH551-356

Angled up.
No. 1.
Tip 4.85mm wide.
Working length
4-3/8in (11cm).

Forceps

Forceps
Zangen
Pinze
Fórcexs
Fórcexs
鉗子

BLAKESLEY Suction Flow Forceps

Working length 4in (10cm).



RH551-701

Straight.
No. 00.
Tip 2.5mm wide.



RH551-702

Straight.
No. 0.
Tip 3.5mm wide.



RH551-703

Straight.
No. 1.
Tip 4mm wide.

RH551-704

Angled up.
No. 00.
Tip 2.5mm wide.

RH551-705

Angled up.
No. 0.
Tip 3.5mm wide.

RH551-706

Angled up.
No. 1.
Tip 4mm wide.

Biopsy and Grasping Forceps



RH550-301

Vertical, angled up 70°. 3mm cup.
Working length 5-1/2in (14cm).

RH550-302

Vertical angled up 70°. 4mm cup.
Working length 5-1/2in (14cm).

RH550-303

Vertical angled up 110°. 3mm cup.
Working length 5in (12.5cm).

RH550-304

Vertical angled up 110°. 4mm cup.
Overall length 5in (12.5cm).

RH550-401

Horizontal double-action, angled up 70°. 3mm cup.
Working length 5-1/2in (14cm).

RH550-402

Horizontal angled up 70°. 4mm cup.
Working length 5-1/2in (14cm).

RH550-403

Horizontal double-action, angled up 110°. 3mm cup.
Working length 5in (12.5cm).

RH550-404

Horizontal angled up 110°. 4mm cup.
Working length 4-7/8in (12.25cm).

KENNEDY-LUSK Biopsy and Grasping Forceps

Cup size 4.5mm x 2.5mm wide. With suction channel.
Working length 4in (10cm).



RH550-271

Straight.

RH550-272

Angled up 45°.

Endo-Sinus Biopsy Forceps



RH551-004

Straight.
Double-action tip.
2.5mm x 3mm cup.
Working length 4-1/2in (11.5cm).

RH551-003

Angled up 110°. Double-action tip.
2.5mm x 3mm cup.
Working length 2-7/8in (7.2cm).



RH551-051

Straight.
2.5mm x 4mm cup.
Working length 4-1/8in (10.5cm).



RH551-001

Angled up 70°. Double-action tip.
2.5mm x 5mm cup.
Working length 3-3/4in (9.5cm).



RH551-002

Angled up 70°. Through-cut.
2.5mm x 6mm cup.
Working length 3-1/2in (9cm).

RH551-052

Angled up 70°. 2.5mm x 6mm cup.
Working length 4in (10cm).

Maxillary Biopsy Forceps

3mm cup.

RH551-581

Angled down 70°.

RH551-582

Angled down 110°.



Giraffe Forceps



RH550-851

Vertical, angled up 55°.
3mm double-action jaw.
Working length 5-1/2in (14cm).

RH550-854

Horizontal, angled up 55°.
3mm double-action jaw.
Working length 5-1/2in (14cm).



RH550-852

Vertical, angled up 55°.
2mm double-action jaw.
Working length 5-1/2in (14cm).



RH550-855

Horizontal, angled up 55°.
2mm double-action jaw.
Working length 5-1/2in (14cm).

RH550-853

Vertical, angled up 90°.
2mm double-action jaw.
Working length 5-1/8in (13cm).

RH550-856

Horizontal, angled up 90°.
2mm double-action jaw.
Working length 5-1/8in (13cm).

HUWEISER Antrum Grasping Forceps

Working length 4in (10cm).

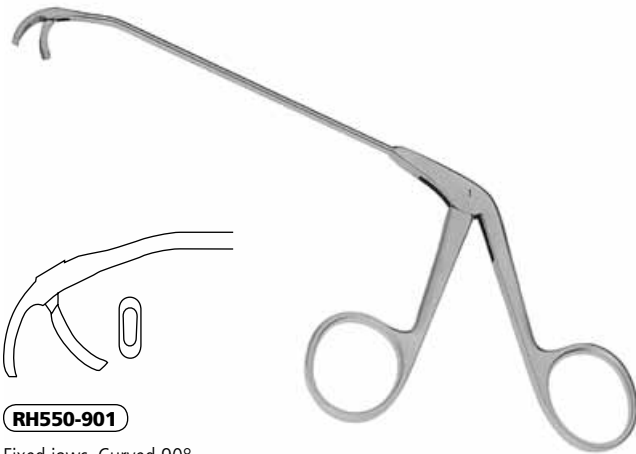

RH550-901

Fixed jaws. Curved 90°.
Movable jaw opens backward up to 120°.

BINNER Polyp Double-Action Forceps

5mm cup.



RH551-251

Angled up 45°.
Working length 4-3/4in (12cm).

RH551-252

Angled up 80°.
Working length 4in (10cm).

RH551-253

Angled up 100°.
Working length 3-1/2in (9cm).



Forceps

Forceps
Zangen
Pinze
Fórcps
Fórcps
鉗子

Thru-Cut Giraffe Forceps

Angled up 70°. Cup 3mm wide. Working length 4-3/4in (12cm).

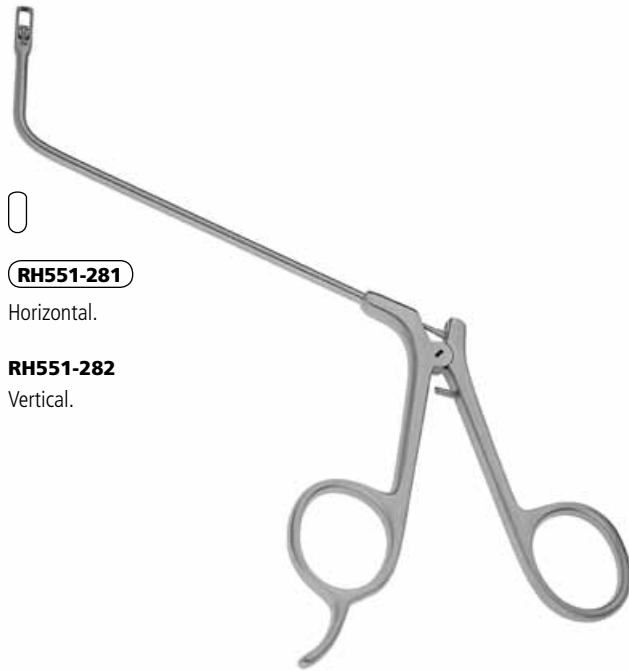

RH551-281

Horizontal.

RH551-282

Vertical.

Ostium Antrum Punch Forceps

Serrated jaws. Back-cutting, 3mm x 7mm bite.



RH3770

Overall length
7in (17.8cm).

Rotating Ostrum Punch

Rotates 360°. Working length 4-3/8in (11cm).

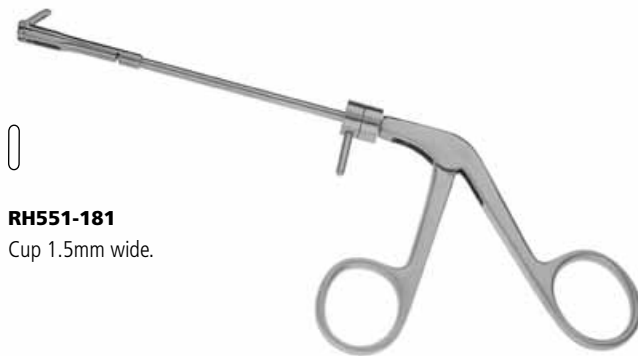

RH551-181

Cup 1.5mm wide.



RH551-182

Cup 2.5mm wide.

Micro WILDE-Type Back Biter

Jaw width 2mm.

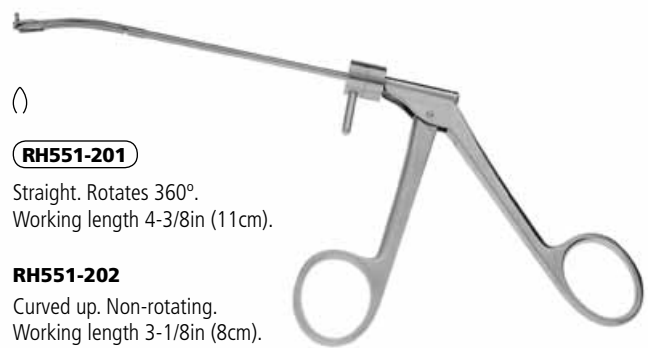

RH551-201

Straight. Rotates 360°.
Working length 4-3/8in (11cm).

RH551-202

Curved up. Non-rotating.
Working length 3-1/8in (8cm).

RH551-203

Curved down. Non-rotating.
Working length 3-1/8in (8cm).

BLAKESLEY Punch Forceps

Working length 4-1/2in (11.5cm).



RH551-291

Straight. No. 00. 2.5mm cup.

RH551-292

Angled. No. 00. 2.5mm cup.



RH551-301

Straight. No. 0. 3.5mm cup.

RH551-302

Up angled. No. 0. 3.5mm cup.



RH551-303

Straight. No. 1. 4mm cup.

RH551-304

Up angled. No. 1. 4mm cup.

STAMMBERGER Antrum Punches

Backward-cutting.



RH550-101

Upside down. Working length 4-1/8in (10.5cm).

RH550-102

Right side. Working length 4-1/8in (10.5cm).

RH550-103

Left side. Working length 4-1/4in (10.7cm).



RH550-104

Slender. Upside down. Working length 4-3/4in (12cm).

RH550-105

Slender. Right side. Working length 4-3/4in (12cm).

RH550-106

Slender. Left side. Working length 4-3/4in (12cm).

STAMMBERGER Antrum Punches

Tip 3mm wide. With flushing port. Working length 4-1/4in (10.9cm).



RH550-107

Right side cutting.

RH550-108

Left side cutting.



STAMMBERGER Circular Punches

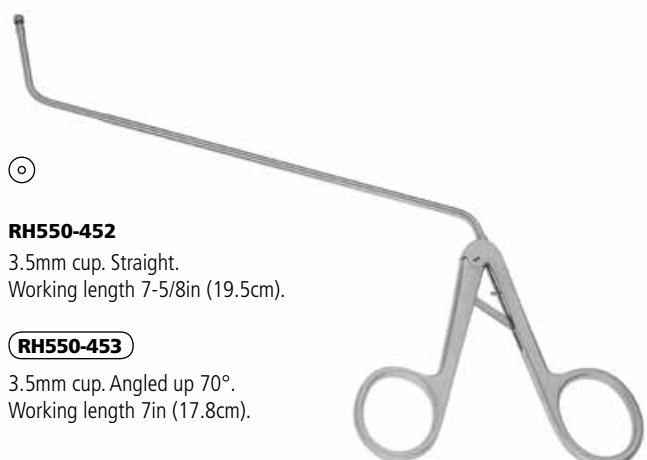

RH550-452

3.5mm cup. Straight. Working length 7-5/8in (19.5cm).

RH550-453

3.5mm cup. Angled up 70°. Working length 7in (17.8cm).



RH550-451

4.5mm cup. Straight. Working length 7-5/8in (19.5cm).

RH550-454

4.5mm cup. Angled up 70°. Working length 7-1/4in (18.5cm).

Punches

Emporte-pièces
Stanzen
Punzoni
Sacabocados
Punções
穿孔

Giraffe Frontal Punches



RH551-381

Vertical 2mm cup.
Angled up 45°.
Working length
6-3/4in (17cm).

RH551-382

Horizontal 2mm cup.
Angled up 45°.
Working length
6-3/4in (17cm).

RH551-383

Vertical 2mm cup.
Angled up 90°.
Working length
6-1/4in (17cm).

RH551-384

Horizontal 2mm cup.
Angled up 90°.
Working length
6-1/4in (17cm).



RH551-385

Vertical 3mm cup.
Angled up 45°.
Working length
6-3/4in (17cm).

RH551-386

Horizontal 3mm cup.
Angled up 45°.
Working length
6-3/4in (17cm).

Antrum Punches

Tip 4mm wide. Working length 5-1/2in (14cm).

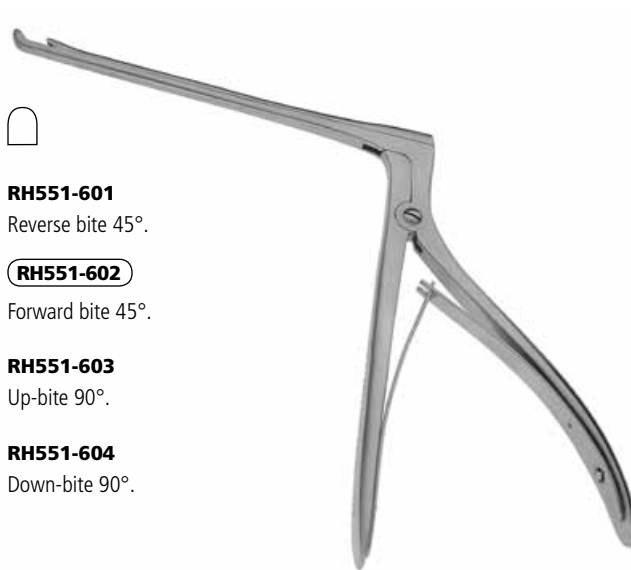

RH551-601

Reverse bite 45°.

RH551-602

Forward bite 45°.

RH551-603

Up-bite 90°.

RH551-604

Down-bite 90°.

HAJEK-KOFFLER Punch

Tip 3.5mm wide.



RH551-621

Reversible.
Working length 6-7/8in (17.5cm).

HAJEK-KOFFLER Thru-Cut Punch

Tip 2.5mm wide.



RH551-622

Working length 6-1/2in (16.5cm).

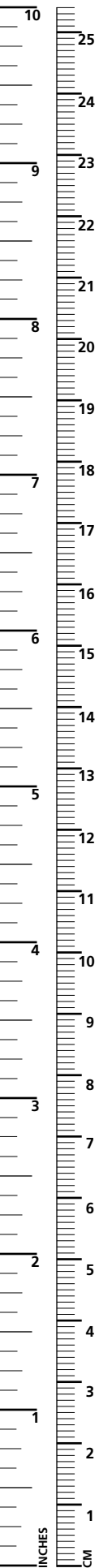

Emporte-pièces/Couteaux/Curettes
 Stanzen/Messer/Küretten
 Punzoni/Bisturi/Curette
 Sacabocados/Cuchillos/Curetas
 Punções/Facas/Curetas
 穿孔/ナイフ/キュレット

McKENTY Punch

Tip 2.1mm wide.



RH551-631

Reversible. Working length
 5-3/4in (14.5cm).



Sickle Knives

Overall length
 7-1/2in (19cm).

RH550-151

Straight.
 Pointed blade,
 length 9mm.

RH550-152

Left.
 Pointed blade,
 length 8.5mm.

RH550-153

Right.
 Pointed blade,
 length 8.5mm.

RH550-154

Straight.
 Rounded blade,
 length 10mm.



Sickle Knives

Overall length
 6-1/2in (16.5cm).

RH551-501

Straight.
 Blade length 4mm.

RH551-502

Curved right.
 Blade length 5mm.

RH551-503

Curved left.
 Blade length 5mm.



Antrum Curettes

Overall length
 7-1/2in (19cm).

RH550-204

Cup 5mm x 5mm wide.

RH550-205

Cup 6mm x 1.5mm wide.

RH550-206

Cup 10mm x 3mm wide.

RH550-201

Cup 10mm x 7mm wide.

RH550-203

Cup 10mm x 9mm wide.

RH550-202

Cup 13mm x 8mm wide.



Frontal Sinus Curettes

Cup 5mm x 2mm wide.

RH550-206S

Straight.
 Overall length
 7-3/4in (19.6cm).

RH550-207

Cup angled 45°. Overall length
 7-1/2in (19cm).

RH550-208

Cup angled 90°. Overall length
 7-1/4in (18.3cm).



Antrum Curettes

10mm x 7mm wide
 fenestrated cup, angled.
 Overall length
 7-1/2in (19cm).

RH550-209

Forward-cutting.

RH550-210

Backward-cutting.



Curettes

Cup
 8mm x 3.5mm wide.

RH551-341

Curved 75°. Overall length
 7in (18cm).

RH551-342

Curved 105°. Overall length
 6-7/8in (17.5cm).



Probes/Elevators

Sondes/Élévateurs
Sonden/Heber
Sonde/Elevatori
Sondas/Elevadores
Sondas/Elevadores
プローブ/エレベーター

Sinus Ostium Seeker

Double ball-ended. Curved.
1.5mm and 2mm tips.

RH550-251

Overall length
7-1/2in (19cm).



Frontal Ostium Seeker

Double ball-ended. Curved.
Right-angle ball hook on one end.

RH550-252

Overall length
8-1/4in (21cm).



Ostrum Probe

Double-ended.
One end angled 90°.

RH551-311

Overall length
7-1/2in (19cm).



SKILLERN Sinus Probe

RH551-402

Overall length
6-1/2in (16.5cm).



Beaded Sinus Probe

1.5mm tip.

RH551-403

Overall length
7-5/8in (19.5cm).



Double Ball-Ended Elevator

2.2mm and 2.5mm tips.

RH551-411

Overall length
7-5/8in (19.5cm).



Sondes/Rugines/Trocarts/Aiguilles
 Sonden/Raspeln/Trokare/Nadeln
 Sonde/Raschietti/Trocar/Aghi
 Sondas/Raspadores/Trócares/Agujas
 Sondas/Raladores/Trocânteres/Agulhas
 プローブ/石目やすり/トロカール/針

Ball Searching Probe

RH551-561

1mm ball tip.
 Overall length
 7-1/2in (19cm).



Suction Rasp

4mm tip.

RH551-331

Overall length
 8-1/2in (21.5cm).



Rasps

Overall length
 7-5/8in (19.5cm).

RH551-332

2.5mm rounded tip.



Trocar and Cannulas

RH551-481

Oblique end.
 5mm trocar tip.
 Overall length
 6-1/2in (16.5cm).

RH551-482

Bill beak end.
 4mm trocar tip.
 Overall length
 6-1/2in (16.5cm).

RH551-483

Oblique end.
 4mm trocar tip.
 Overall length
 6-1/2in (16.5cm).

RH551-484

Oblique end.
 3mm trocar tip.
 Overall length
 6-7/8in (17.5cm).



Septum Needles

0.8mm needle.

RH551-511

Angled shaft.
 Straight tip.
 Overall length
 5-1/8in (13cm).

RH551-512

Straight shaft.
 Tip angled tip 90°.
 Overall length
 4-3/8in (11cm).



Septum Needle

0.8mm needle.
 Straight tip.
 Bayonet shaft.

RH551-513

Overall length
 5-1/8in (13cm).



Mirrors/Adenotomes/Blades

Miroirs/Adénotomes/Lames
 Spiegel/Adenotome/Klingen
 Specchi/Adenotomi/Lame
 Espejos/Adenótomos/Cuchillas
 Espelhos/Adenótomos/Lâminas
 鏡/切除刀/ブレード

Laryngeal Mirrors

Very thin model, with handle. Mirror finish.

RH4701-001

Size 00. Diameter 10mm.

RH4701-002

Size 0. Diameter 12mm.

RH4701-003

Size 1. Diameter 14mm.

RH4701-004

Size 2. Diameter 16mm.

RH4701-005

Size 3. Diameter 18mm.

RH4701-006

Size 4. Diameter 20mm.

RH4701-007

Size 5. Diameter 22mm.

RH4701-008

Size 6. Diameter 24mm.

RH4701-009

Size 7. Diameter 26mm.



MUELLER-LaFORCE Adenotomes

Three-piece construction with thin-wall basket.
 Overall length 9-1/4in (23.5cm).

RH4300

18.5mm blade. Overall length
 9-1/4in (23.5cm).

RH4301

16mm blade.

RH4302

13mm blade.

RH4303

10mm blade.



Adenotome Blades

For MUELLER-LaFORCE, SHAMBAUGH and ABELSON adenotomes. Smooth-cutting.

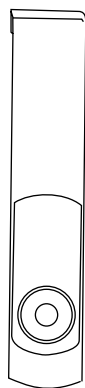

RH4304-000

Infant, size 0.
 50mm x 10mm wide.

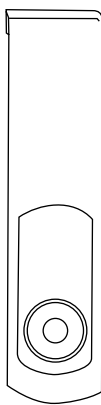

RH4304-001

Small, size 1.
 50mm x 13mm wide.

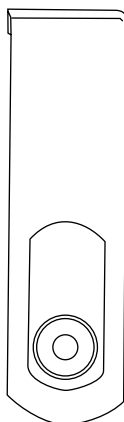

RH4304-002

Medium, size 2.
 55mm x 16mm wide.

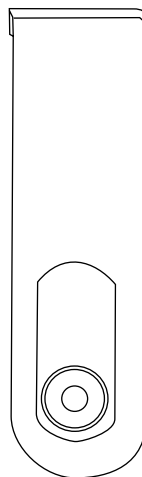

RH4304-003

Large, size 3.
 59mm x 18.5mm wide.



Adenotomes/Curettes
 Adenotome/Küretten
 Adenotomi/Curette
 Adenótomos/Curetas
 Adenótomos/Curetas
 切除刀/キュレット

LaFORCE-GRIESHABER Adenotomes

Three-piece tubular construction.

RH4320

Large size, 19mm blade.
 Overall length
 9-1/2in (24.2cm).

RH4321

Medium size, 15.8mm blade.
 Overall length
 9-1/2in (24.2cm).

RH4322

Small size, 12.7mm blade.
 Overall length
 9-3/4in (24.7cm).

RH4323

Infant size, 8.7mm blade.
 Overall length
 8-1/2in (21.5cm).



RH4324-001
 12.7mm blade.



RH4324-003
 8.7mm blade.



RH4324-006
 15.8mm blade.



RH4324-010
 19mm blade.



SHAMBAUGH Reverse Adenotomes

RH4330

Large size,
 22mm blade.
 Overall length
 9-1/8in (23.1cm).

RH4331

Medium size,
 19mm blade.
 Overall length
 9-1/4in (23.5cm).

RH4332

Small size,
 16mm blade.
 Overall length
 9in (22.8cm).



VOGEL Adenoid Curette

Infant size, 7mm.
 Mirror and Satin finish.



RH4400

Overall length
 8-1/2in (21.6cm).



INGERSOLL Adenoid Curette

Small child size, 10.5mm.



RH4410

Overall length
 8-1/2in (21.6cm).



○ Instrument pictured

◆ Most widely used patterns

Curettes

Curettes
Küretten
Curette
Curetas
Curetas
キュレット

BARNHILL Adenoid Curettes

Mirror and Satin finish.

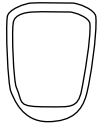

RH4420

Size 0, 11mm.
Overall length
8-1/2in (21.6cm).

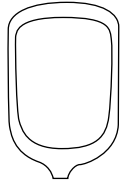

RH4421

Size 1, 13mm.
Overall length
8-1/2in (21.6cm).

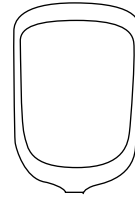

RH4422

Size 2, 15mm.
Overall length
8-5/8in (21.9cm).

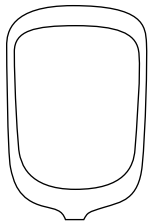

RH4423

Size 3, 17mm.
Overall length
8-3/4in (22.2cm).

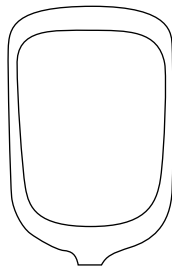

RH4424

Size 4, 20mm.
Overall length
8-3/4in (22.2cm).



STUBBS Adenoid Curettes

Overall length 8-1/2in (21.6cm). Mirror and Satin finish.

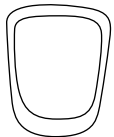

RH4430

Size 0, 11mm.

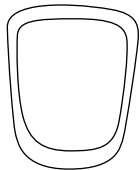

RH4431

Size 1, 14mm.

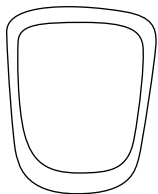

RH4432

Size 2, 16mm.

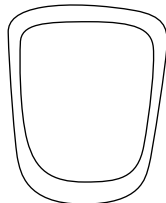

RH4433

Size 3, 18mm.

ROSENMUELLER Fossae Curette

Size 8mm.
Mirror and Satin finish.

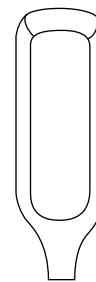

RH4440

Overall length
9in (22.9cm).



Curettes/Forceps/Emporte-pièces
 Küretten/Zangen/Stanzen
 Curette/Pinze/Punzoni
 Curetas/Fórceps/Sacabocados
 Curetas/Fórceps/Punções
 キュレット/鉗子/穿孔

Reverse Curve Adenoid Curettes

Mirror and Satin finish. Overall length 8-1/2in (21.6cm).

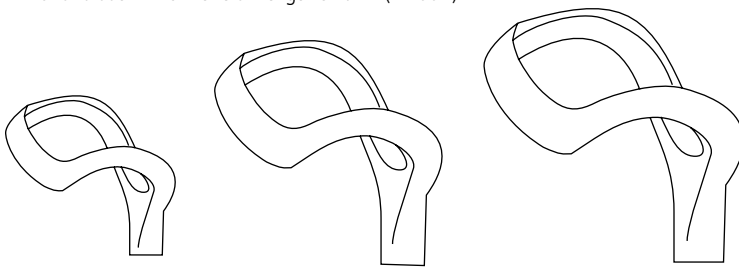

RH4445-100
 Size 0, 11mm.

RH4445-001
 Size 1, 13mm.

RH4445-002
 Size 2, 15mm.

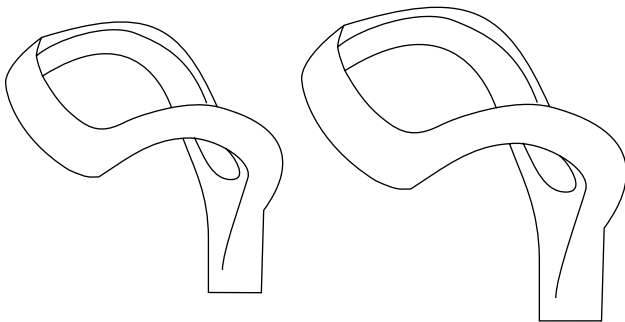

RH4445-003
 Size 3, 17mm.

RH4445-004
 Size 4, 19mm.

JONES Curettes

Mirror and Satin finish.

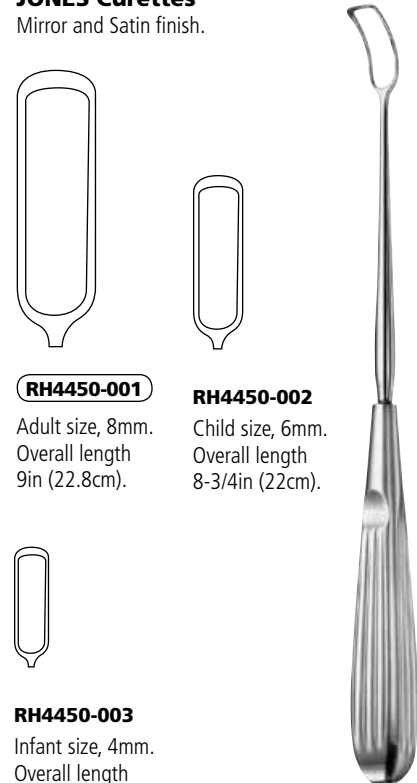

RH4450-001
 Adult size, 8mm.
 Overall length
 9in (22.8cm).

RH4450-002
 Child size, 6mm.
 Overall length
 8-3/4in (22cm).

RH4450-003
 Infant size, 4mm.
 Overall length
 8-1/2in (21.2cm).

PANG Nasopharyngeal Biopsy Forceps

Cup-shaped angular jaw. 3mm diameter.
 Shaft is malleable at proximal end.



RH4540
 Working length 5-5/8in (14.3cm).

MELTZER Adenoid Punches

Working length 5-1/2in (14cm).

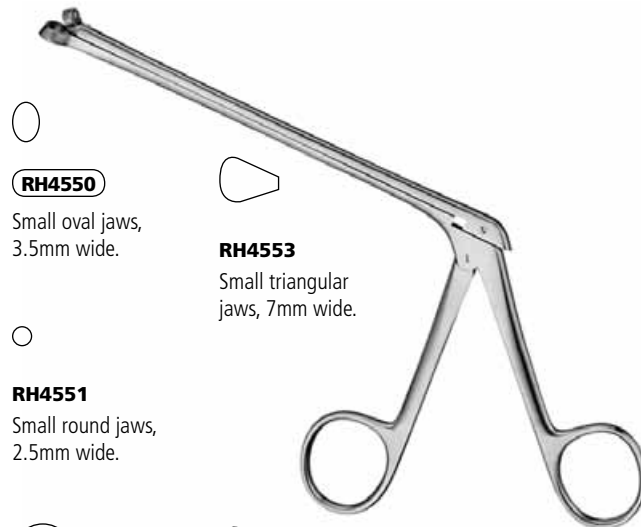

RH4550
 Small oval jaws,
 3.5mm wide.

RH4553
 Small triangular
 jaws, 7mm wide.

RH4551
 Small round jaws,
 2.5mm wide.

RH4552
 Large round jaws,
 8mm wide.

RH4554
 Large triangular jaws,
 8mm wide.

Punches/Specula/Forceps

Emporte-pièces/Spéculum/Forceps
Stanzen/Spekula/Zangen
Punzoni/Speculum/Pinze
Sacabocados/Espéculos/Fórceps
Punções/Espéculos/Fórceps
穿孔/檢鏡/鉗子

MELTZER Adenoid Punches

Curved shank. Triangular jaws. Overall length 5-5/16in (13.5cm).

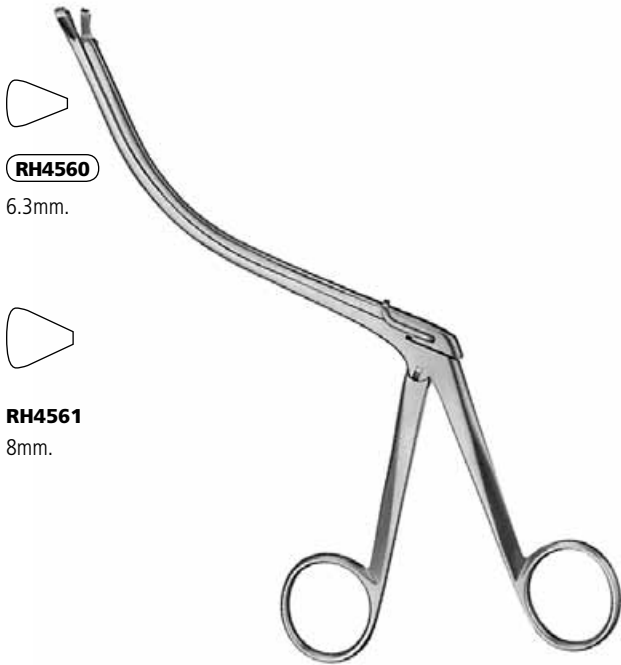

YANKAUER Nasopharyngeal Specula

For direct examination of nasopharynx.
Oval end 27mm x 18mm wide.



ST. CLAIR-THOMPSON Adenoid Forceps

◆ **RH4640**
Overall length
7-3/8in (18.7cm).



MAGIELSKI Coagulating Forceps

Bayonet-shaped with curved tips. Forceps are completely insulated except for tips.

RH4651
Overall length
7-7/8in (19.9cm).

RH4652
Monopolar cord.
Bovie plug.
Overall length 10ft (3m).



Tongue Depressor

Double-ended and cross-serrated.
 Overall length 6-1/2in (16.5cm).

MO10

Blades 16mm and 21mm wide.



ANDREWS Tongue Depressor

Serrated blade.

MO20

Blade 16mm wide.



WEDER Tongue Depressors

MO30

Large. Blade 1-3/8in (3.5cm) wide.

MO31

Small. Blade 1-1/8in (2.8cm) wide.



BOSWORTH Tongue Depressor

MO40

Blade 1in (2.5cm) wide.



Retractors

Écarteurs
Wundspreizer/Retraktoren
Divaricatori
Separadores
Retradores
リトラクター

DENHARDT Mouth Gag

MO90-1

Overall length
5in (12.7cm).

MO90-2

Replacement silicone inserts.



JENNINGS Mouth Gag

Self-retaining, with automatic ratchet lock. Mirror and Satin finish.

MO100

Adult size. Overall length
8in (20.3cm).

MO101

Child size. Overall length
7in (17.8cm).

MO102

Infant size. Overall length
6-1/4in (15.9cm).



SLUDER-JANSEN Mouth Gag

Curved arms to fit face. Ratchet lock.

MO115

Blade 10mm wide.
Overall length
4in (10.2cm).

MO110

Blade 10mm wide.
Overall length
5-1/2in (14cm).

MO120

Blade 20mm wide.
Overall length
5-1/2in (14cm).



DINGMAN Mouth Gags

MO130

Complete set, includes frame
and three sizes of tongue blades.

MO130-001

Frame only.

MO130-002

Blade No. 1. 2-1/2in x 1in (6.5cm x 2.5cm) wide.

MO130-003

Blade No. 2. 2-3/4in x 1-1/4in (7cm x 2.9cm) wide.

MO130-004

Blade No. 3. 3-1/4in x 1-1/4in (8.2cm x 3.2cm) wide.

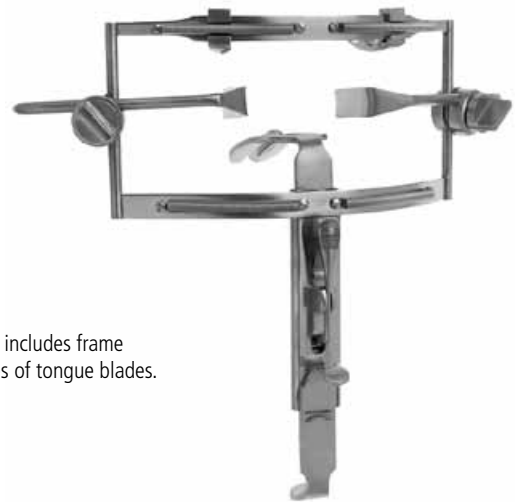

Écarteurs/Lames
Wundspreizer/Retraktoren/Klingen
Divaricatori/Lame
Separadores/Cuchillas
Retratores/Láminas
リトラクター/ブレード

DAVIS-CROWE Mouth Gags

Standard pattern, with double bite. Complete with frame (MO156-right or MO154-left), tooth plate (MO160), and four tongue blades (MO161, MO162, MO163, MO164).

MO150

For patient's right.

MO152

For patient's left.

◆ **MO154**

Frame only, for patient's left.

◆ **MO156**

Frame only, for patient's right.

**DAVIS-CROWE Mouth Gag Tongue Depressor Blades****MO161**

No. 2. 6.5cm x 2.3cm wide.

MO161-001

No. 2-1/2. 7.5cm x 2.4cm wide.

MO162

No. 3. 8cm x 2.4cm wide.

MO162-001

No. 3-1/2. 9cm x 2.5cm wide.

MO163

No. 4. 9.3cm x 2.5cm wide.

MO163-001

No. 4-1/2. 10cm x 2.6cm wide.

MO164

No. 5. 10.8cm x 2.6cm wide.

**DAVIS-CROWE Mouth Gag Tongue Depressor Blades**

Without tube.

MO165

No. 2. 6.5cm x 2.6cm wide.

MO166

No. 3. 7.7cm x 2.7cm wide.

MO167

No. 4. 9cm x 2.7cm wide.

MO168

No. 5. 10cm x 2.7cm wide.

**DAVIS-CROWE Mouth Gag Tooth Plate****MO160**

No. 1. 3.4cm x 2cm wide.



Retractor Blades/Elevators

Larmes d'écarteur/Élévateurs
Wundspreizerblätter/Heber
Lame divaricatore/Elevatori
Cuchillas de separadores/Elevadores
Lâminas de retrator/Elevadores
リトラクターのブレード/エレベーター

McIVOR Mouth Gags

Universal size, providing two-point contact on silicone covered ring. Easily adjustable.

MO140

Complete with three sizes of blades.
Blade lengths are 6.8cm, 8.5cm and 9.5cm, all 25mm wide.

MO141

Frame only.

MO142

Blade No. 4.
Large.
3-3/4in x 1in
(9.5cm x 2.5cm) wide.

MO143

Blade No. 3.
Medium.
3-1/2in x 1in
(8.5cm x 2.5cm) wide.

MO144

Blade No. 2-1/2.
Small.
2-5/8in x 1in
(6.8cm x 2.5cm) wide.

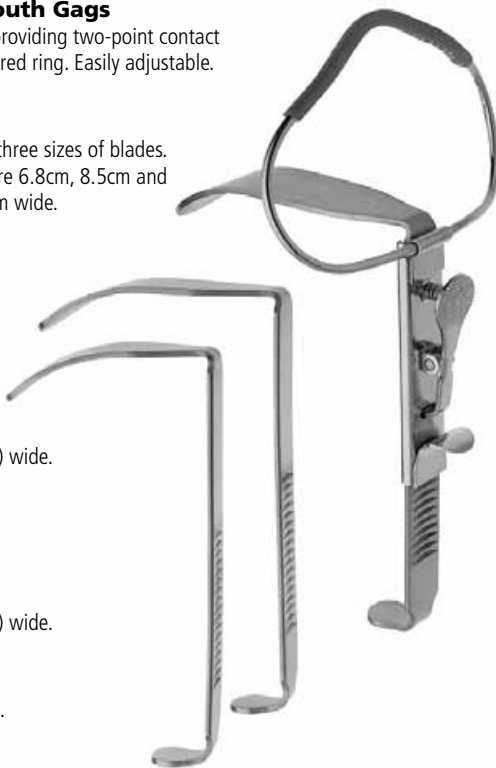

Ring Retractor Blades

For use with the DAVIS-CROWE or McIVOR mouth gag frame. A groove the full length of the blade holds the endotracheal tube, protects it from moving, kinking or closure by teeth. Four sizes, right and left.

MO171

No. 2. Right.
2-1/4in x 7/8in
(5.7cm x 2.3cm) wide.

MO172

No. 3. Right.
3in x 1-1/8in
(7.2cm x 2.7cm) wide.

MO173

No. 4. Right.
3-1/2in x 1-1/4in
(8.8cm x 3.3cm) wide.

MO173-001

No. 5 Right.
3-3/4in x 1-1/2in
(9.5cm x 3.8cm).

MO174

No. 2. Left.
2-1/4in x 7/8in
(5.7cm x 2.3cm) wide.

MO175

No. 3. Left.
3in x 1-1/8in
(7.2cm x 2.7cm) wide.

MO176

No. 4. Left.
3-1/2in x 1-1/4in
(8.8cm x 3.3cm) wide.

MO177

No. 5 Left.
3-3/4in x 1-1/2in
(9.5cm x 3.8cm).

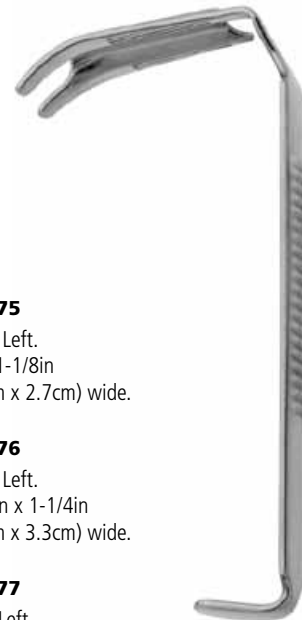

BLAIR Elevator

Curved laterally.

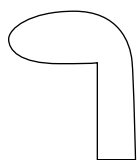

MO280

No. 1, dull.
Overall length
7-1/2in (19.1cm).

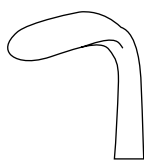

MO282

No. 3, sharp.
Overall length
7-7/8in (20cm).

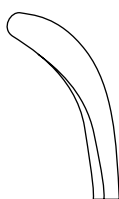

MO284

No. 5, dull.
Overall length
8in (20.3cm).

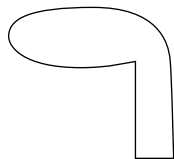

MO281

No. 2, dull.
Overall length
7-5/8in (19.4cm).

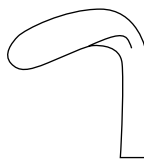

MO283

No. 4, sharp.
Overall length
7-7/8in (20cm).

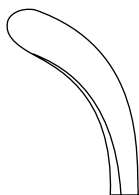

MO285

No. 6, dull.
Overall length
8-1/4in (21cm).



LOGAN Lip Traction Bow

MO440

Small.
1-1/8in (2.8cm) spread.

MO441

Medium.
1-3/16in (3cm) spread.

MO442

Large.
1-3/8in (3.5cm) spread.



Dissecteurs/Crochets
 Dissektoren/Haken
 Dissettori/Uncini
 Diseccionadores/Ganchos
 Escalpelos/Ganchos
 切開器/フック

JAZBI Suction Tonsil Dissector

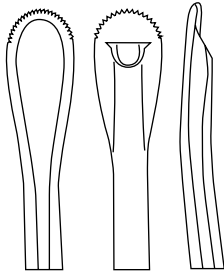

MO1300

Blade 11/32in (9mm) wide.
 Overall length
 7-1/4in (18.4cm).



HURD Tonsil Dissector and Pillar Retractor

MO1280

Overall length
 8-3/4in (22.2cm).



COLVER Examining Retractor Hook

Probe pointed.

MO1340

Overall length
 7-5/8in (19.4cm).



LILLIE Pillar Retractor

MO1360

Overall length
 7-1/2in (19cm).



BOETTCHER Tonsil Hooks

Sharp. Overall length
 8-1/4in (21cm).

MO1380

Two large prongs.



BROPHY Tenacula

Sharp. Mirror and Satin finish.
 Overall length
 7-3/4in (19.7cm).



MO330

Heavy.



MO340

Light.



Forceps/Clamps

Forceps/Clamps
Zangen/Klemmen
Pinze/Morse
Fórceps/Pinças
Fórceps/Pinças
鉗子/クランプ

WHITE Tonsil Seizing Forceps

MO1400

Overall length
9-1/2in (24.0cm).



WHITE-LILLIE Tonsil Seizing Forceps

◆ **MO1410**

Overall length
7-1/2in (19.1cm).



COLVER Tonsil Pillar Grasping Forceps

5 x 6 teeth.

MO1420

Overall length
7-5/8in (19.4cm).



MAGIELSKI Tonsil Seizing Forceps

Two opposing rows of non-traumatic ALLIS-type teeth.



MO1460

Overall length
7-1/2in (19.1cm).



TYDINGS Tonsil Seizing Forceps

Two-prong jaws. With catch.

MO1471-1

Overall length
7-1/4in (18.4cm).



TIVNEN Tonsil Seizing Forceps

Guard on lock.
3 x 3 prongs.

MO1480

Overall length
8-1/2in (21.6cm).



Divers
 Verschiedenes
 Varie
 Varios
 Diversos
 その他

LEWIS Tonsil Snare

Large studded wheel.
 Includes 12 No. 8 snare
 wires, length 4in (10.2cm).

MO1960

Overall length
 10in (25.4cm).



EVES Tonsil Snares

Includes 12 wires. Overall length
 11-1/8in (28.3cm).

MO1970

With ratchet.

MO1980

Without ratchet.



TYDINGS Tonsil Snare

One-piece model, with tubular cannula. Includes 12 wires.

◆ **MO1990**

Working length 6-5/8in (16.9cm).

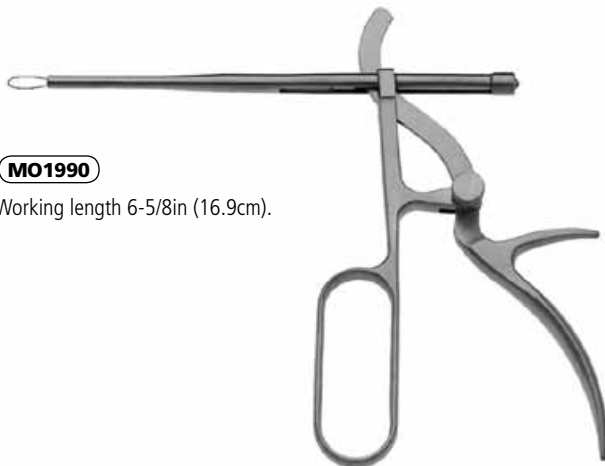

TYDINGS Automatic Ratchet Snare

Stylet is automatically engaged and held in position by ratchets,
 and is quickly released. Uses No. 7 snare wires. Includes 12 wires.
 Mirror and Satin finish.

MO1995-1

Working length 8-1/2in (22.0cm).

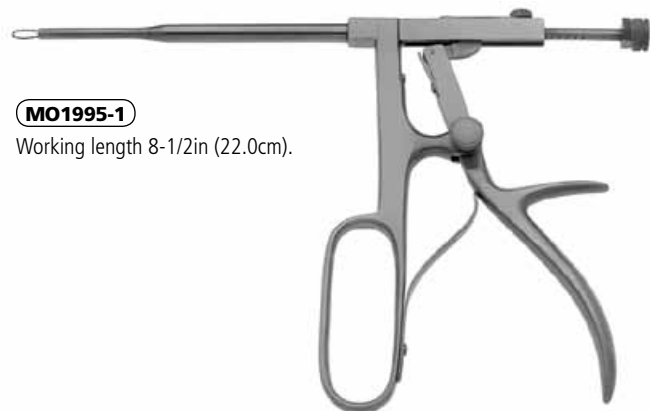

Miscellaneous/Knives

Divers/Couteaux
Verschiedenes/Messer
Varie/Bisturi
Varios/Cuchillos
Diversos/Facas
その他/ナイフ

BROWN Tonsil Snare

Includes 12 wires.



MO2000

Working length 5-3/4in (14.5cm).

Cut Snare Wires

Overall length 4in (10.2cm).
Available by the dozen (12)
or by the gross (144).



MO2010-007

Size 7.
Diameter .43mm.

MO2010-008

Size 8.
Diameter .48mm.

MO2010-009

Size 9.
Diameter .53mm.

BECK-SCHENCK Tonsillectome

Supplied with one medium
BECK loop, one straight
cannula, one wire carrier
and snare wires.

MO1910

Overall length
10-1/4in (26cm).



TYDINGS Tonsil Knife

Mirror and Satin finish.

MO1080

Overall length
8in (20.3cm).



DEAN Tonsil Knife

Double-edged. Straight.
Mirror and Satin finish.

MO1130

Overall length
8-1/4in (21cm).

**ROBERTSON Tonsil Knife**

Double-edged.
Curved blade.
Mirror and Satin finish.

MO1170

Overall length
8-1/4in (21cm).

**COLVER Tonsil Knife**

Serrated blade. Mirror and Satin finish.

MO1220

Overall length
8-1/4in (21cm).

**FISHER Tonsil Knife and Dissector**

Blunt end, semi-sharp anterior edge and semi-sharp teeth.
Mirror and Satin finish.

MO1230

Overall length
8-1/4in (21cm).



Forceps/Clamps/Scissors

Forceps/Clamps/Ciseaux
Zangen/Klemmen/Scheren
Pinze/Morse/Forbici
Fórceps/Pinzas/Tijeras
Fórceps/Pinças/Tesoura
鉗子/クランプ/鉗

BOETTCHER (SCHNIDT) Tonsil Artery Forceps

Slightly curved jaws.



MO1700

Overall length
7-1/2in (19cm).



SAWTELL Tonsil Artery Forceps

Fully curved jaws.

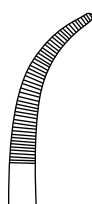

◆ **MO1710**

Overall length
7-1/2in (19cm).



McHENRY Tonsil Artery and Sponge Holding Forceps

Open finger rings. Slightly curved jaws.

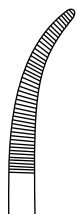

MO1720

Overall length
8in (20.3cm).



BOETTCHER Scissors

Curved double-edged blades.
Mirror finish.

MO1610

Overall length
7-1/2in (19.1cm).



Ciseaux/Porte-aiguilles
 Scheren/Nadelhalter
 Forbici/Porta-ago
 Tijeras/Sostenes de agujas
 Tesoura/Porta-agulhas
 鉋/針ホルダー

LILLIE Scissors

Blades curved-on-flat.
 Mirror finish.

MO1620

Overall length
 8in (20.3cm).



DEAN Scissors

Angled blades, length 3cm from mid-screw.
 One blade serrated. Handles slightly curved.
 Mirror finish.

MO1650

Overall length
 6-3/4in (17.1cm).



BAUM Tonsil Needle Holder

Slotted jaw.



MO2310

Overall length
 7in (17.8cm).



BLAIR-BROWN Needle Holder

For fine needles and sutures.



MO810

Overall length
 5-1/4in (13.3cm).



Needle Holders/Punches

Porte-aiguilles/Emporte-pièces
Nadelhalter/Stanzen
Porta-ago/Punzoni
Sostenes de agujas/Sacabocados
Porta-agulhas/Punções
針ホルダー/穿孔

FERRIS-SMITH Needle Holder

Delicate jaws with opening for suture.



MO800

Overall length
6-1/8in (15.6cm).



BAUM-METZENBAUM Tonsil Needle Holder

Holder slotted, curved jaws.



MO2320

Overall length
7in (17.8cm).



HARTMANN Tonsil Punch

Round jaws. Diameter 9.2mm.

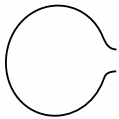

MO2150

Working length 5-1/2in (14cm).



SCHMEDEN Tonsil Punch

Triangular jaws. 12.7mm x 9.7mm wide.

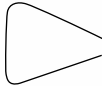

MO2170

Working length 5-1/2in (14cm).

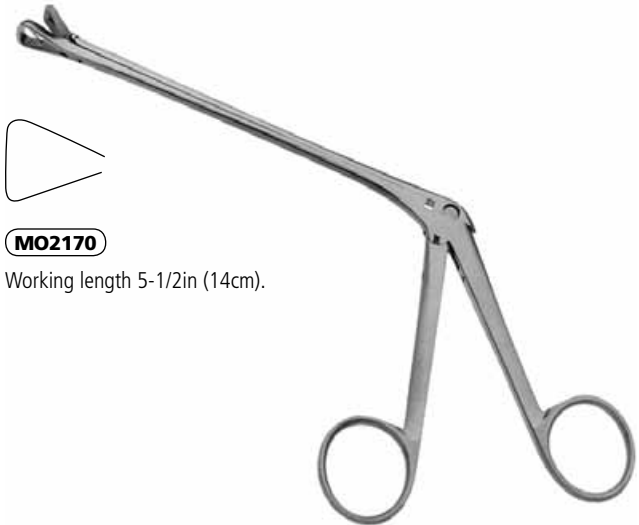

Forceps/Aiguilles/Pieds à coulisse
Zangen/Nadeln/Messschieber
Pinze/Aghi/Estesiometri
Fórceps/Agulhas/Calibres
鉗子/針/キヤリパー

DOCKTOR Suture, Needle and Tissue Forceps

1 x 2 teeth.



MO552

Overall length
4-3/4in (12.1cm).



BROPHY-DESCHAMPS Needles

For passing pilot sutures. Small curve. Overall length 8-1/2in (21.6cm).



MO760

Right.



DINGMAN Malleable Passing Needle

Curved. Mirror finish.

RH2750

Overall length
6-3/4in (17.2cm).



CASTROVIEJO-Type Caliper

Straight. 0-40mm.

MO9930

Overall length
7in (17.8cm).



TESSIER-Type Caliper

MO9935

Overall length
10-1/4in (26cm).



Scissors/Forceps/Specula

Ciseaux/Forceps/Spéculum
 Scheren/Zangen/Spekula
 Forbici/Pinze/Speculum
 Tijeras/Fórceps/Espéculos
 Tesoura/Fórceps/Espéculos
 鉋/鉋子/檢鏡

MacKENTY-Type Scissors

Curved, strong blades.
 Sharp points. Mirror finish.

MO610

Overall length
 6-3/4in (17.1cm).



SMITH-Type Wire Cutting Scissors

Maximum cutting capacity 0.3mm for hard wire and 0.6mm for soft wire.

MO9985

Overall length
 6-1/4in (15.9cm).



Wire-Twisting Forceps

MO9980

Overall length
 6-3/4in (17.1cm).



TESSIER-Type Nasal Specula

Overall length 5-1/2in (14cm).

MO9990

Blade length 30mm.

MO9992

Blade length 45mm.

MO9994

Blade length 70mm.



JACKSON Tracheotomic Bistoury

Curved, with blunt probe point.

BE360

Overall length
 6-3/4in (17cm).



JACKSON Tracheal Hemostatic Forceps

Full curved, serrated jaws.

BE380

Overall length
 5-1/2in (14cm).

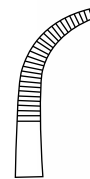

Dilatateurs/Crochets/Écarteurs
 Dilatoren/Haken/Wundspreizer/Retraktoren
 Dilatori/Uncini/Divaricatori
 Diladores/Ganchos/Separadores
 Diladores/Ganchos/Retratores
 拡張器/フック/リトラクター

JACKSON Tracheal Tenaculum

BE390

Overall length
 5-1/4in (14.6cm).



TROUSSEAU-JACKSON Tracheal Dilator

Two probe-pointed blades.

◆ **BE460**

Overall length
 5-3/8in (13.7cm).



LABORDE Tracheal Dilator

Three prongs.

◆ **BE465**

Overall length
 5-1/2in (14cm).



NEW'S Tracheotomy Hook

BE395

Overall length
 6-1/2in (16.5cm).



JACKSON Tracheal Retractor

Double-ended.
 Flat blade 1/2in (1.3cm) wide
 on one end,
 two prongs
 on the other end.

BE400

Overall length
 7in (17.8cm).



HUPP Trachea Hook

◆ **BE391**

Overall length
 6-1/2in (16.5cm).



HUPP Trachea Retractor

Three prongs and hook.

BE392

Overall length
 6-1/4in (16cm).



Retractors/Miscellaneous

Écarteurs/Divers
Wundspreizer/Retraktoren/Verschiedenes
Divaricatori/Varie
Separadores/Varios
Retradores/Diversos
リトラクター/その他

LUKENS Thymus Retractor

Double-ended.
Blades 12mm and 8mm wide.

BE410

Overall length
7in (17.8cm).



Tracheal Retractors

Overall length 6-1/2in (16.5cm).



BE420

2 sharp prongs.

BE421

2 blunt prongs.

BE422

3 sharp prongs.

BE423

3 blunt prongs.



DAVIS Retractor

Double-ended, with slightly lipped blades.
Blades 19mm x 9mm wide and
23mm x 6.4mm wide.
Mirror and Satin finish.

MO420

Overall length
6in (15.2cm).



ANDREWS Tracheal Retractors

Set of three. Spring wire.

BE430

Arm lengths 2-1/4in (5.7cm), 2-3/8in (6cm) and 2-7/8in (7.3cm).

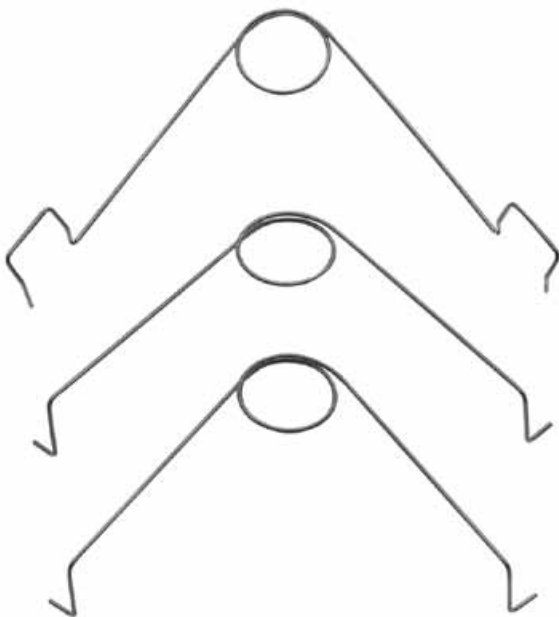

JACKSON Laryngeal Atomizer

Spray tube length 4in (10.2cm). Partially Chrome Plated.

BE670

Glass bottle-style
supplied as available.
Overall length
9in (22.9cm).



Manches de couteau/Canules/Aiguilles
 Messergriffe/Kanülen/Nadeln
 Impugnatura di bisturi/Cannule/Aghi
 Mangos de cuchillos/Cánulas/Agujas
 Cabos de facas/Cânulas/Agulhas
 ナイフハンドル/カニューレ/針

LYNCH Laryngeal Knife Handle

For use with No. 11 and No. 15 BARD-PARKER blades.

BE800

Overall length
 11-1/2in (29.2cm).



ABRAHAM Laryngeal Cannula

Malleable, with bulbous round point. Luer lock hub. Mirror finish.

BE590

Overall length
 6in (15.2cm).



PRITCHARD Syringe

With BE590 Cannula. Chrome Plated.

BE660

1 oz capacity.



Mediastinoscopy Aspirating Needle

22GA. Mirror finish.



BE8230

Working length 8-1/2in (22cm).

Forceps/Scissors

Forceps/Ciseaux
Zangen/Scheren
Pinze/Forbici
Fórceps/Tijeras
Fórceps/Tesoura
鉗子/鋏



JAKO Microlaryngeal Grasping Forceps

Grasping tip 1.5mm x 8.5mm wide.
Working length 9-1/2in (24cm).



BE2820

Straight. Pass diameter 3.5mm.



BE2821

Angled left. Pass diameter 5mm.



BE2822

Angled right. Pass diameter 5mm.

JAKO Microlaryngeal Cup-Shaped Forceps

Cup diameter 2.5mm.
Pass diameter 4.5mm.
Working length 9-1/2in (24cm).



BE2825

Straight.



BE2826

Angled left.



BE2827

Angled right.

JAKO Microlaryngeal Cup-Shaped Forceps

Angled up. Pass diameter 5.5mm.
Working length 9-1/4in (23.5cm).



BE2828

Cup diameter 2.5mm.



BE2829-001

Oval cup 2.5mm x 8mm wide.

JAKO Microlaryngeal Scissors

Blade length 6mm. Working length 9-1/4in (23.5cm).

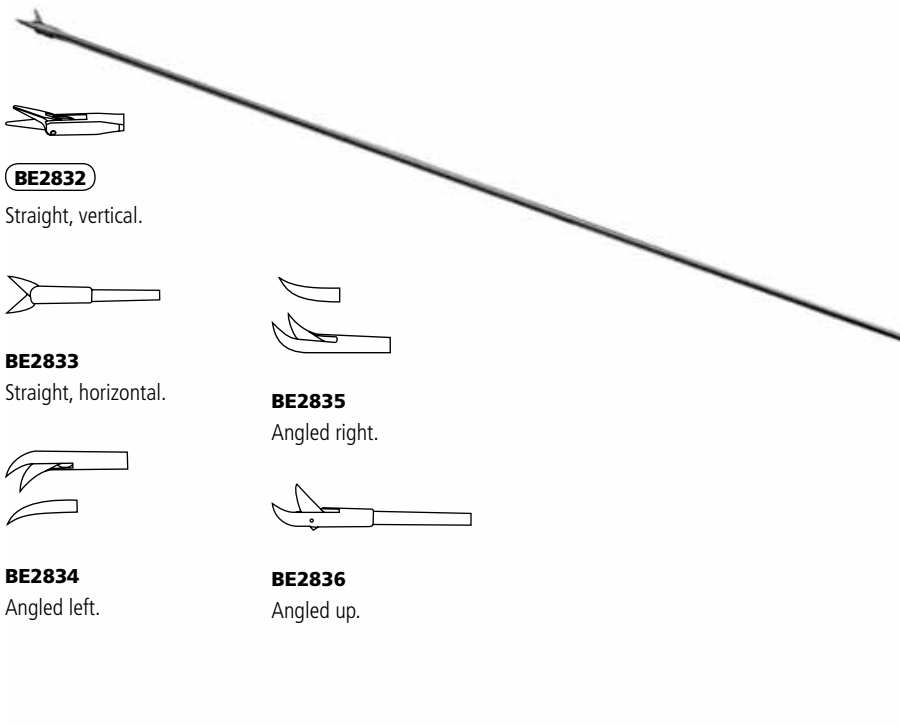

BE2832

Straight, vertical.

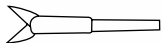

BE2833

Straight, horizontal.

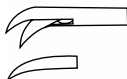

BE2834

Angled left.



BE2835

Angled right.



BE2836

Angled up.

Couteaux/Sondes/Miroirs/Tubes d'aspiration
 Messer/Sonden/Spiegel/Absaugschläuche
 Bisturi/Sonde/Specchi/Tubi di aspirazione
 Cuchillos/Sondas/Especjos/Tubos de succión
 Facas/Sondas/Espeelhos/Tubos de sucção
 ナイフ/プローブ/鏡/吸引チューブ

JAKO Laryngeal Knives

Mirror and Satin finish.
 Overall length 11-5/8in (29.5cm).



BE2840

Straight blade, length 12mm.



BE2841

Sickle-shaped blade, length 10mm.

JAKO Laryngeal Probes

Working length 8-5/8in (22cm).
 Overall length 11-5/8in (29.5cm).

BE2846

Straight.



BE2847

Angled.

JAKO Laryngeal Mirror

Mirror diameter 7/16in (1.1cm).
 Mirror and Satin finish.

BE2852

Working length 8-5/8in (22cm).



JAKO Laryngeal Suction Tube

7Fr. Open-ended.

BE3043

Working length 8-5/8in (22cm).



Laryngeal Sponge Carrier

BE3188

Working length 8-1/2in (21.6cm).
 Overall length 10in (25.4cm).



JESBERG Aspirating Tube

Curved. Diameter 2mm. Mirror finish.

BE1810

Overall length 9-1/4in (23.5cm).



Suction Tubes

Tubes d'aspiration
Absaugschläuche
Tubi di aspirazione
Tubos de succión
Tubos de sucção
吸引チューブ

JACKSON Velvet Eye Aspirating Tubes

Distal tip has a smooth, oval-shaped opening on each side in opposing positions, and a closed blunt end.

BE3000

Diameter 4mm. Overall length 10in (25.4cm).

BE3001

Diameter 3mm. Overall length 16in (40.6cm).

BE3002

Diameter 4mm. Overall length 16in (40.6cm).

BE3003

Diameter 4mm. Overall length 18in (45.7cm).

BE3005

Diameter 4mm. Overall length 22in (55.9cm).

BE3006

Diameter 4mm. Overall length 26in (66cm).



JACKSON Open-End Aspirating Tubes

Diameter 4mm.

BE3010

Overall length 10in (25.4cm).

BE3011

Overall length 16in (40.6cm).

BE3012

Overall length 18in (45.7cm).

BE3013

Overall length 20in (50.8cm).

BE3014

Overall length 22in (55.9cm).

BE3015

Overall length 26in (66cm).



HOLINGER Open-End Aspirating Tube

Diameter 2.6mm. Mirror finish.

BE3025

Overall length 16-1/4in (41.3cm).



Customer Support

Our highly trained, centralized V. Mueller customer support team is available to take your calls from 7:00 a.m. to 6:00 p.m. (CST), M-F. This group is dedicated to providing a full range of support services, including:

- Order placement
- Order inquiries
- Delivery information
- Product information
- Pricing inquiries

If we can be of assistance, please call us at **800.323.9088**.

PATTERSON Laryngeal Forceps

Cup-shaped jaws. 12mm x 4mm wide.



BE2410

Working length 11in (28cm).

JACKSON Laryngeal Forceps

Cross-action.

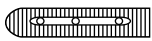

BE700

Serrated, toothed jaw.



FRAENKEL Laryngeal Forceps

Alligator-style. Working length 8in (20.3cm).

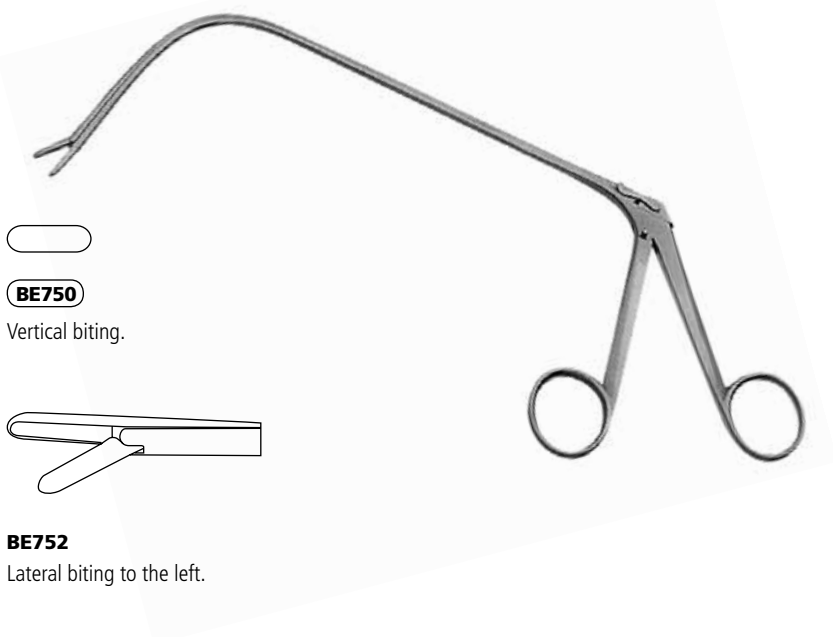

BE750

Vertical biting.

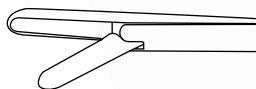

BE752

Lateral biting to the left.

Forceps

Forceps
Zangen
Pinze
Fórcexs
Fórcexs
鉗子



JACKSON Laryngeal Rotation Forceps

Alligator-style. Serrated jaws behind tooth tip.
20mm x 2.5mm wide.



BE2360

Working length 11-3/8in (28.9cm).

JACKSON Laryngeal Punch Forceps

Jaws 6mm x 3mm wide. Pass diameter 6mm.



BE2390

Working length 11-1/4in (28.5cm).

JACKSON Laryngeal Forceps

Delicate. Angled cup. Working length 11in (28cm).



BE2430

2mm



BE2431

4mm

JACKSON Laryngeal Grasping Forceps

Alligator-style. Grasping tip 20mm x 4mm wide.
Pass diameter 5mm.

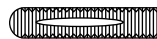

BE2351

Working length 14-1/8in (35.9cm).



BE2355

Working length 23-5/8in (60cm).

JACKSON Laryngeal Forceps

Delicate. Straight cup.



BE2420

2mm. Working length
11in (28cm).



BE2421

4mm. Working length
11-1/2in (29.2cm).



BE2422

5mm. Working length
11in (28cm).



BE2423

6mm. Working length
11in (28cm).



BE2424

4mm. Working length
18-7/8in (48cm).

Bronchial Biopsy Forceps

Malleable shaft.

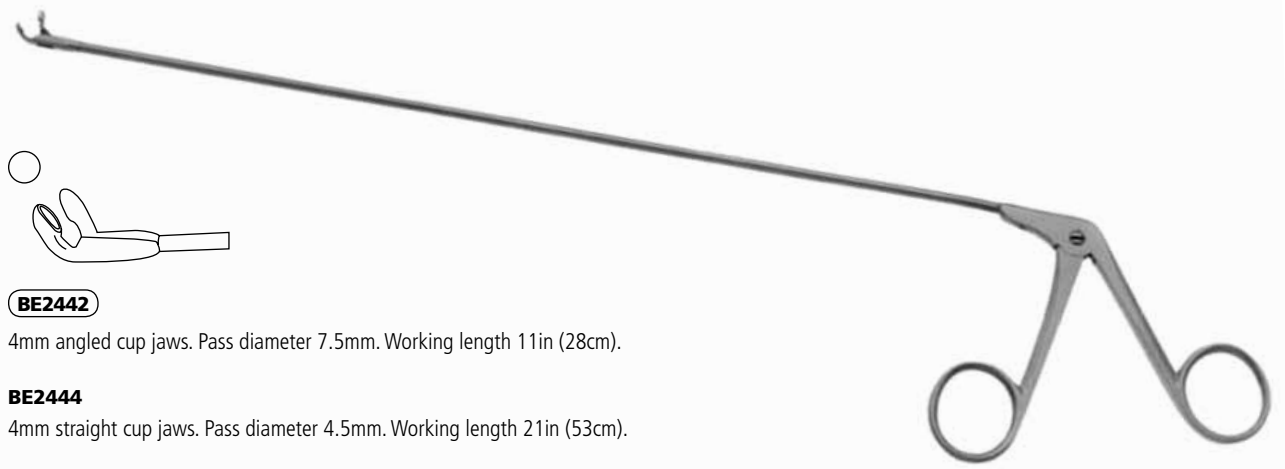

BE2442

4mm angled cup jaws. Pass diameter 7.5mm. Working length 11in (28cm).

BE2444

4mm straight cup jaws. Pass diameter 4.5mm. Working length 21in (53cm).

Laryngeal, Bronchial Grasping Forceps

Serrated jaws on non-bulging shaft. Grasping tip 11mm x 3mm wide. Pass diameter 4.5mm.

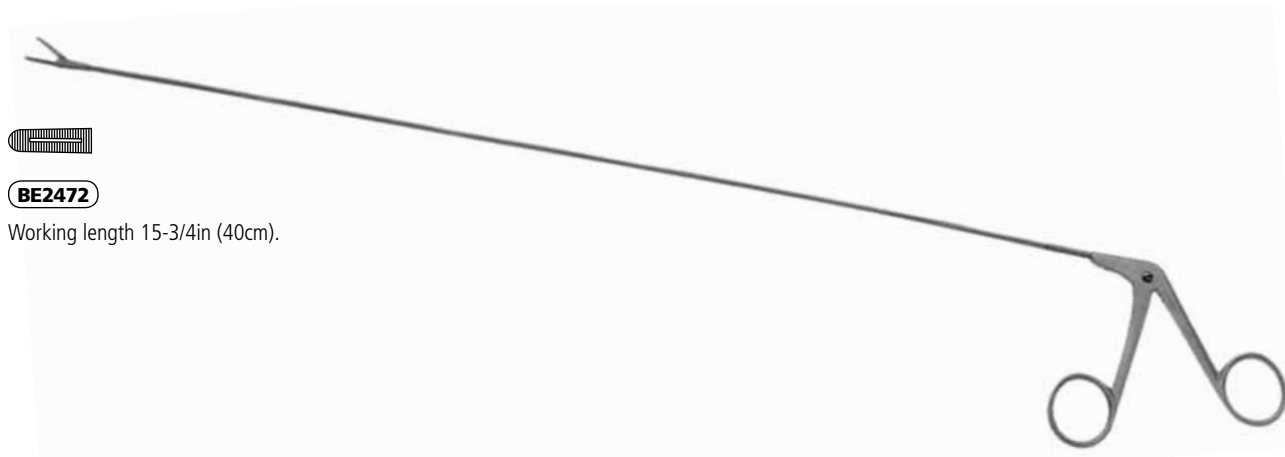

BE2472

Working length 15-3/4in (40cm).

Alligator Grasping Forceps

X-Small size, delicate. Grasping tip 8mm x 3mm wide. Pass diameter 4mm.



BE2480

Working length 11in (28cm).

Forceps

Forceps
Zangen
Pinze
Fórcps
Fórcps
鉗子

Bronchoscopic Forceps

Double-articulated, cupped grasping jaws, 8mm x 3mm wide. Pass diameter 3.5mm.

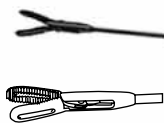

BE2230

Working length 15in (38cm).

Bronchoscopic Forceps

Double-articulated, alligator grasping jaws, 10mm x 3mm wide. Pass diameter 4mm.

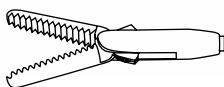

BE2242

Working length 19-5/8in (50cm).

KAHLER Bronchial Grasping Forceps

Alligator style. Jaw 2mm wide. Pass diameter 5mm.

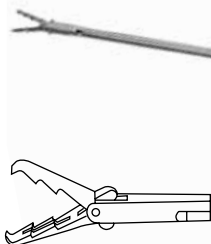

BE2471

Working length 19-5/8in (50cm).

JACKSON Alligator Grasping Forceps

X-Small size, delicate. Grasping tip 8mm x 3mm wide. Pass diameter 4mm.



BE2491

Working length 13in (33cm).

PATTERSON Specimen and Tissue Forceps

X-Small size, delicate. Grasping tip 8mm x 3mm wide. Pass diameter 4mm.

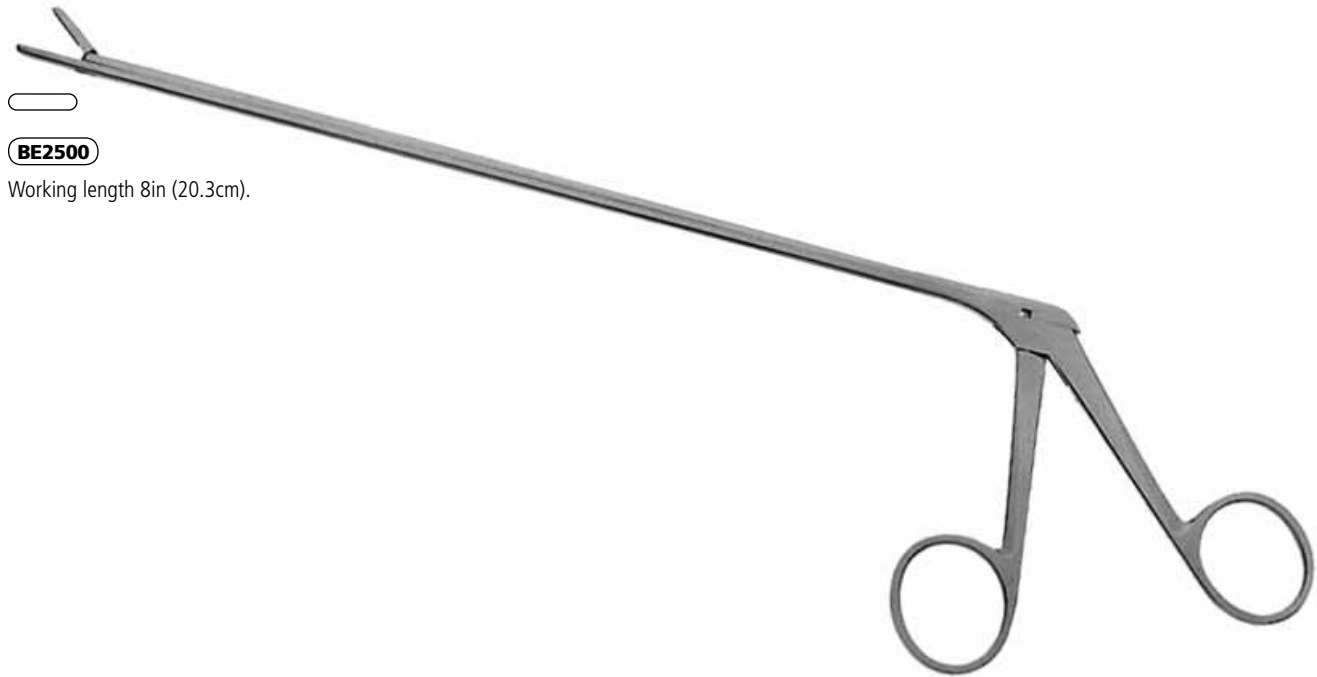

BE2500

Working length 8in (20.3cm).

JACKSON Biopsy Forceps

X-Small size, delicate. Grasping tip 8mm x 3mm wide. Pass diameter 4mm.

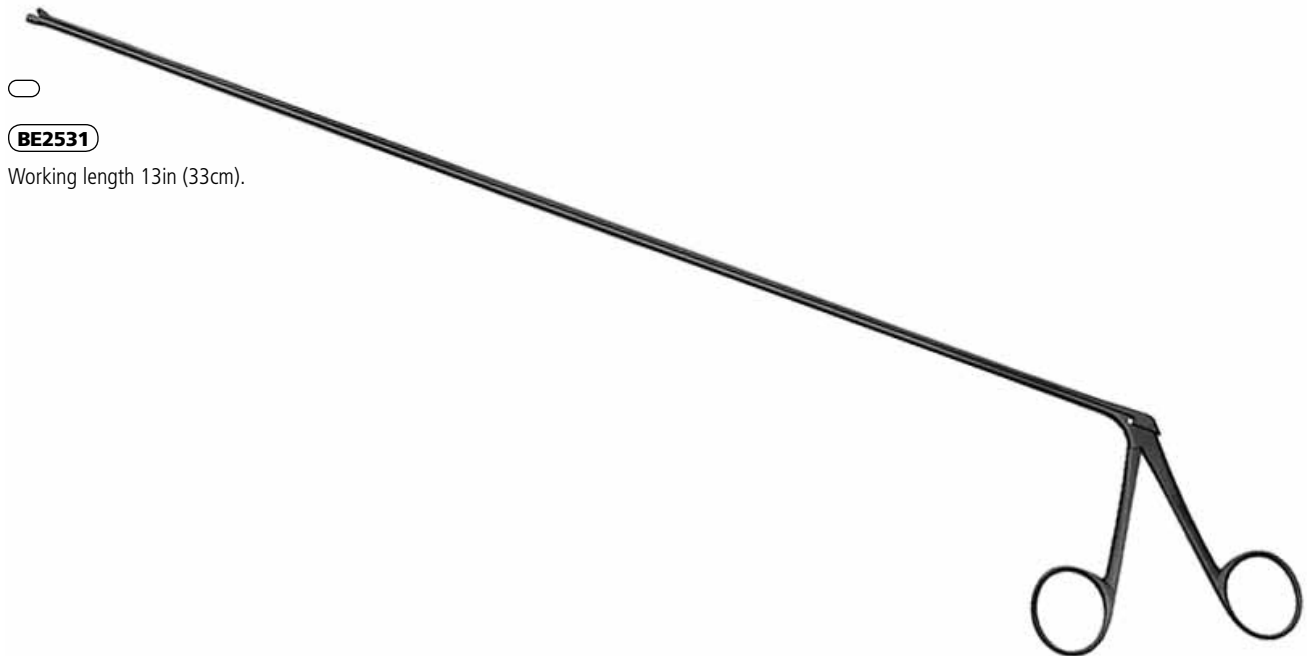

BE2531

Working length 13in (33cm).

Rulers/Dilators

Règles/Dilatateurs
Lineale/Dilatatoren
Righe/Dilatatori
Reglas/Dilatadores
Réguas/Dilatadores
定規/擴張器

Bronchoscopic Rule

Graduated in centimeters. Chrome Plated.

BE4500

Working length 30cm.



To learn how the IMPRESS system can help improve process performance, reduce immediate-use steam sterilization, decrease case delays, and improve patient care by monitoring instrument flow within your facility, contact your V. Mueller sales representative.

PLUMMER Esophageal Dilating Set

Chrome Plated.

BE4750

Consists of 16 conical-shaped olives sizes 15Fr. to 45Fr., one small olive tip, numbered stand, fiberglass staff (BE4751) and flexible metal spiral tip (BE4752).

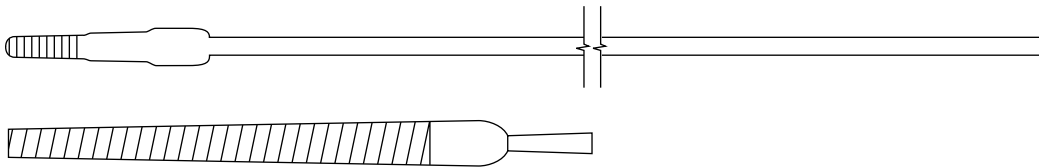

BE4751

Fiberglass staff.

BE4752

Flexible metal spiral tip for use with Fiberglass Staff BE4751.

Oral Surgery Instruments

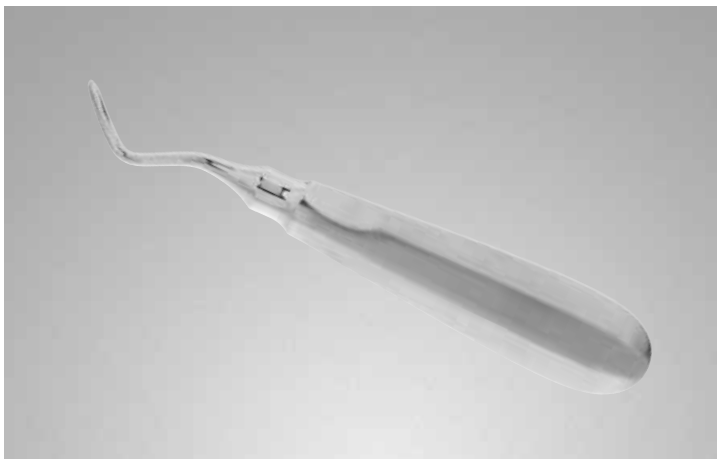

Retractors

Écarteurs
Wundspreizer/Retraktoren
Divaricatori
Separadores
Retratores
リトラクター

TESSIER-Type Malleable Retractors

Double-ended. Black Oxidized finish.
Overall length 8-3/4in (22.2cm).

MO9350

Blades 10mm and 12mm wide.

MO9355

Blades 15mm and 17mm wide.



AUSTIN-Type Retractors

Blade tip tapered, with teeth.

MO9400

No. 1. Tapered handle.
Curved down. 4-1/2in (11.4cm).

MO9405

No. 2. Curved down. 3in (7.5cm).

MO9410

No. 3. Curved to the side.
4-1/2in (11.4cm).



AUSTIN Dental Retractor

Two blunt prongs at distal end.

MO390

Blade 3in x 1/4in (7.6cm x 6.3mm) wide.



TESSIER-TYPE Retractors

For retracting soft tissue. Double-ended.
Black Oxidized finish. Overall length
6-1/4in (15.9cm).

MO9360

Small. Blades
20mm x 12mm wide and
30mm x 16mm wide.

MO9365

Medium. Blades
30mm x 12mm wide and
35mm x 16mm wide.

MO9370

Deep. Blades
35mm x 12mm wide and
45mm x 16mm wide.



UNIVERSITY OF MINNESOTA-Type Cheek Retractor/Tongue Depressor

MO9500

Overall length
5-1/2in (14cm).



OBWEGESER-Type Tissue Retractors

Flat blade. Overall length 8-3/4in (22.2cm).

MO9000

Curved down. 25mm x 7mm wide.

MO9001

Curved down. 30mm x 10mm wide.

MO9002

Curved down. 42mm x 10mm wide.

MO9004

Curved down. 55mm x 12mm wide.

MO9006

Curved down. 70mm x 14mm wide.

MO9008

Curved down. 80mm x 16mm wide.

MO9010

Curved up. 42mm x 13mm wide.

MO9012

Curved up. 60mm x 12mm wide.

MO9014

Curved up. 80mm x 16mm wide.

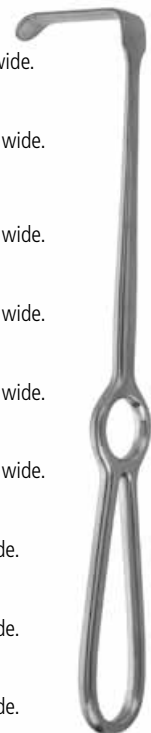

OBWEGESER-Type Ramus Retractor

Curved. Flat blade. Overall length 8-3/4in (22.2cm).

MO9100

70mm x 11mm wide.

**OBWEGESER-Type Soft Tissue Retractors**

Concave blade. Overall length 8-3/4in (22.2cm).

MO9200

Curved up. 25mm x 7mm wide.

MO9202

Curved up. 35mm x 10mm wide.

MO9204

Curved up. 42mm x 10mm wide.

MO9206

Curved up. 55mm x 12mm wide.

MO9208

Curved up. 70mm x 14mm wide.

MO9210

Curved up. 80mm x 16mm wide.

MO9212

Curved down. 16mm x 5mm wide.

MO9300

Curved down. 25mm x 7mm wide.

MO9302

Curved down. 35mm x 10mm wide.

MO9304

Curved down. 42mm x 10mm wide.

MO9306

Curved down. 55mm x 12mm wide.

MO9308

Curved down. 70mm x 14mm wide.

MO9310

Curved down. 80mm x 16mm wide.

**OBWEGESER-Type Ramus Retractors**

Curved. Concave blade. Overall length 8-3/4in (22.2cm).

MO9315

70mm x 15mm wide.

MO9316

70mm x 22mm wide.

**OBWEGESER-Type Mandibular Channel Retractors**

Overall length 6-3/4in (17.1cm).

MO9318

8mm wide.

MO9320

10mm wide.

**OBWEGESER-Type Nasal Spine Retractor**

Overall length 8-3/4in (22.2cm).

MO9105Straight. Flat blade.
42mm x 10mm wide.**MO9106**Straight. Concave blade.
42mm x 10mm wide.

Retractors

Écarteurs
Wundspreizer/Retraktoren
Divaricatori
Separadores
Retratores
リトラクター

OBWEGESER-Type Chin Retractor

Overall length 6-1/8in (15.5cm).

MO9110

Slight up curve.

MO9108

Strong up curve.



OBWEGESER-Type Channel Retractor

Overall length 6-1/4in (15.9cm).

MO9120

Malleable.



Medial Ramus Retractors

Overall length 7-3/4in (19.7cm).

MO9130

Right.

MO9131

Left.



ORINGER Lip Retractors

MO9450

Small.

MO9451

Medium.

MO9452

Large.

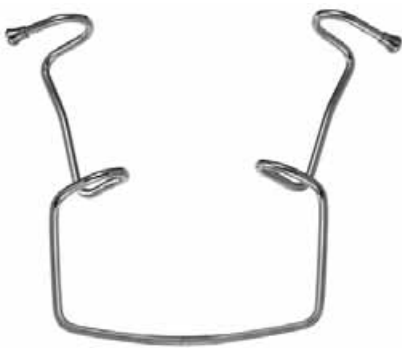

Cheek Retractors

Swivel blades.

MO2410

Small. Blades 36mm wide.
Overall length
7-5/8in (19.4cm).

MO2421

Large. Blades 43mm wide.
Overall length
8-1/4in (20.9cm).



Oral Blade Retractor

Overall length 4-1/4in (10.8cm).

RH1279

Blade

8mm x 10mm wide.



Écarteurs/Clamps
Wundspreizer/Retraktoren/Klemmen
Divaricatori/Morse
Separadores/Pinças
Retradores/Pinças
リトラクター/クランプ

SEWELL Orbital Retractors

No slot. Overall length 6-1/4in (16cm).

MO1042-414

Blade 7mm x 52mm wide.

MO1042-413

Blade 9mm x 51mm wide.

MO1042-412

Blade 11mm x 50mm wide.

MO1042-411

Blade 13mm x 67mm wide.

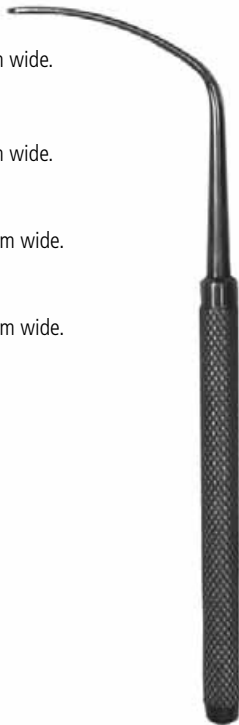

Oral Orbital Rim Retractor

MO9135

Overall length
6-1/2in (16.5cm).



Extra Oral Cavity Retractor

MO9140

Overall length
9-3/4in (25cm).



OBWEGESER Alveolar Retractor

Concave blade. Overall length
8-3/4in (22.2cm).

MO9090

Blade
70mm x 12mm x 22mm wide.



OBWEGESER-RAMUS Stripper

Overall length 7in (17.8cm).

MO9619

Narrow.



OBWEGESER-RAMUS Clamps

With wide shield. Overall length 8in (20.3cm).



MO9666

Right.

MO9668

Left.

Retractors

Écarteurs
Wundspreizer/Retraktoren
Divaricatori
Separadores
Retradores
リトラクター

HENAHAN-Type Retractor

Double-ended. Overall length
8in (20.3cm).

MO9380

Size 2-3.



HENAHAN-Type Retractors

Overall length
7in (17.8cm).

MO9385

Size 1.

MO9390

Size 2.

MO9395

Size 3.



HARGIS-Type Mandibular Body Retractor

Overall length
7in (18cm).

MO9150



LE VASSEUR-MERRILL-Type Retractor

Overall length 9in (25.5cm).

MO9160



BAUER-Type Intraoral Retractors

Overall length 8in (20cm).

MO9170

Left.

MO9180

Right.



DONOVAN-Type Orbital Rim Retractor

Overall length 8in (20cm).

MO9190

Double-ended.



Anterior Border Stripper

Overall length 7-1/2in (19cm).

MO9618



OBWEGESER-Type Mandibular Periosteal Strippers

Overall length 8in (20.3cm).

MO9670

5mm wide.

MO9675

7mm wide.

MO9680

9mm wide.



Exodontia Oral Curettes

Double-ended. Overall length 7in (17.8cm).



MO11000

No. 9.

MO11005

No. 10.

MO11010

No. 11.

MO11015

No. 12.



MOLT-Type Exodontia Oral Curette

Overall length 7in (17.8cm).



MO11018

No. 1.

MO11019

No. 2.

MO11020

No. 4.

MO11021

No. 5R.

MO11022

No. 5L.

MO11024

No. 13.



MOLT-Type Exodontia Oral Curette

Double-ended.
Overall length 7in (17.8cm).

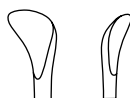

MO11025

Size 2-4.



LUCAS-Type Curettes

Overall length 7in (17.8cm).

MO11030

No. 1R-1L.



MO11035

No. 2R-2L.

MO11040

No. 3R-3L.

MO11045

No. 5.



Osteotomes

Ostéotomes
Osteotome
Osteotomi
Osteótomos
Osteótomos
骨刀

SMITH SAGITTAL-Type Split Separators

9mm x 10mm wide.
Overall length 7in (17.8cm).

MO9650
Curved right.

MO9655
Curved left.



SMITH-Type Ramus Separator

Overall length 8in (20.3cm).

MO9660
Blade 12mm.



EPKER-Type Osteotomes

Overall length 7in (17.8cm).

MO9710
Straight. 1.2mm x 4mm wide.

MO9712
Slightly curved. 1.2mm x 4mm wide.

MO9714
Straight. 1.2mm x 6mm wide.

MO9716
Slightly curved. 1.2mm x 6mm wide.

MO9718
Sharply curved. 1.2mm x 6mm wide.

MO9720
Straight. 1.2mm x 8mm wide.

MO9722
Sharply curved. 1.2mm x 8mm wide.



TESSIER-Type Osteotomes

Flat handle. Overall length 6-1/4in (15.9cm).

MO9780
Straight. Blade 2mm wide.

MO9782
Straight. Blade 3.5mm wide.

MO9784
Straight. Blade 5mm wide.

MO9786
Curved. Blade 5mm wide.

MO9788
Straight. Blade 7mm wide.

MO9790
Curved. Blade 7mm wide.

MO9792
Straight. Blade 10mm wide.

MO9794
Curved. Blade 10mm wide.

MO9796
Straight. Blade 14mm wide.



TESSIER-Type Osteotomes

Hexagonal handle. Straight.
Overall length 6-1/4in (15.9cm).

MO9802
Blade 10mm wide.

MO9804
Blade 15mm wide.



TESSIER-KAWAMOTO-Type (Modified) Osteotome

Overall length 7in (17.8cm).

MO9806
Blade 9.5mm wide.



OBWEGESER-Type Nasal Osteotome

Overall length
7-1/2in (19cm).

MO9700

Ball ends.



DAUTREY-MUNRO-Type Osteotomes

MO9730

Blade 4mm wide. Overall length
6-1/4in (15.9cm).

MO9732

Blade 6mm wide. Overall length
6-1/4in (15.9cm).

MO9734

Blade 8mm wide. Overall length
6-1/4in (15.9cm).

MO9736

Blade 10mm wide. Overall length
6-1/4in (15.9cm).

MO9738

Blade 12mm wide. Overall length
6-1/4in (15.9cm).

MO9740

Blade 14mm wide. Overall length
6-1/4in (15.9cm).

MO9742

Blade 16mm wide. Overall length
6-1/4in (15.9cm).

MO9744

Slight curve. Blade 8mm wide.
Overall length
6-3/4in (17.1cm).

MO9746

Strong curve. Blade 8mm wide.
Overall length
6-3/4in (17.1cm).

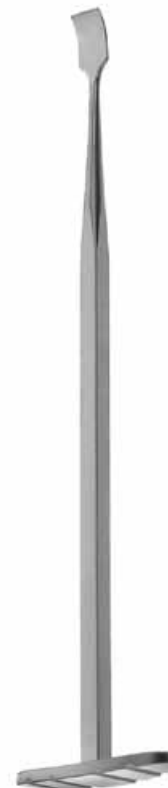

DUNN-DAUTREY-Type Spatula Osteotomes

Overall length 6-1/4in (15.9cm).

MO9750

Straight. Blade 8mm wide.

MO9752

Straight. Blade 6mm wide.

MO9754

Straight. Blade 4mm wide.

MO9756

Slightly curved. Blade 6mm wide.

MO9758

Strongly curved. Blade 6mm wide.



OBWEGESER-Type Nasal Septum Osteotomes

Overall length 7-1/4in (18.4cm).

MO9768

Blade 4mm wide.

MO9770

Blade 6mm wide.

MO9772

Blade 8mm wide.



TESSIER-Type Splitters

Curved. Hexagonal handle.
Overall length 6-1/4in (15.9cm).

MO9695

Blade 10mm wide.

MO9697

Blade 15mm wide.



Osteotomes

Ostéotomes
Osteotome
Osteotomi
Osteótomos
Osteótomos
骨刀

Exodontia Bone Chisel

MO9699

Overall length
6in (15.2cm).



OBWEGESER Orbital Osteotomes

Overall length 9in (23cm).

MO9703

Small. 8mm tip.

MO9701

Large. 11mm tip.



OBWEGESER Mobilizer

MO9192

Overall length
9in (23cm).



OBWEGESER Osteotomes

Overall length 6in (15.2cm).

MO9820

2.5mm tip.

MO9824

3mm tip.

MO9826

4mm tip.

MO9828

6.5mm tip.



OBWEGESER Wedge Osteotomes

Overall length 8-3/4in (22.2cm).

MO9708

8mm wide.

MO9709

16mm wide.



OBWEGESER-Type Maxillary Osteotome

Blade 10mm wide.

Overall length 9-1/4in (23.5cm).

MO9702

Curved.



Ostéotomes/Élévateurs
 Osteotome/Heber
 Osteotomi/Elevatori
 Osteótomos/Elevadores
 Osteótomos/Elevadores
 骨刀/エレベーター

OBWEGESER-Type Splitting Osteotomes

Overall length 8-1/2in (21.6cm).

MO9705

Blade 7mm wide.

MO9706

Blade 10mm wide.



OBWEGESER-Type Splitting Osteotomes

Overall length 8-3/4in (22.2cm).

MO9775

Blade 8mm wide.

MO9776

Blade 12mm wide.

MO9777

Blade 16mm wide.

MO9778

Blade 20mm wide.



TESSIER-Type Maxillary Levers

Blade 9mm wide. Overall length 6in (15.2cm).

MO9970

Right.

MO9975

Left.



Oral Elevator

Serrated. Overall length 6in (15.2cm).



MO11050

No. 46R.

MO11051

No. 46.



Exodontia Oral Elevator

Straight. Overall length 6in (15.2cm).



MO11055

No. 301.



CRYER Crossbar Elevators

Overall length 4-7/8in (12.4cm).

MO11-11L

No. 11L.

MO11-11R

No. 11R.

MO11091

No. 1.

MO11092

No. 2.

MO11093

No. 40.



Elevators

Élévateurs
Heber
Elevatori
Elevadores
Elevadores
エレベーター

Exodontia Oral Elevator

Overall length 6in (15.2cm).

MO11-11A

No. 11A.

MO11-81

No. 81.



Cameron Elevator

MO11053

Overall length
6-1/4in (16cm).



Exodontia Elevators

Overall length 6in (15.2cm).

MO11-190

No. 190.

MO11-191

No. 191.



Oral Elevators

Overall length 6in (15.2cm).

MO11-71

No. 71.

MO11-72

No. 72.



Oral Elevators

Overall length 6in (15.2cm).

MO11-77

No. 77.

MO11-77R

No. 77R.



BROWN Triangular Elevator

MO11072

Overall length
6in (15.2cm).



Exodontia Elevators

Overall length 6in (15.2cm).

MO11-34

No. 34.

MO11-34S

No. 34S.

**EXCELLO-Type Elevators**

Overall length 6in (15.2cm).

MO11-83

No. 83.

MO11-84

No. 84.

**Exodontia Elevators**

Overall length 6in (15.2cm).

MO11-302

No. 302.

MO11-303

No. 303.

**OBWEGESER Periosteal Elevators**

Flat-ended. Overall length 7in (17.8cm).

MO9609

6mm tip.

MO9610

7mm tip.

MO9611

With beveled edge.

7mm tip.

MO9612

9mm tip.

MO9613

11mm tip.

**OBWEGESER Periosteal Elevators**Double-ended.
Overall length 8-1/2in (21.6cm).**MO9691**Blunt/Sharp.
6mm tip.**SELDIN Oral Elevators**

Overall length 7-3/4in (19.7cm).

MO11121

No. 2.

MO11122No. 22.
Angled down.**MO11123**

No. 1L.

MO11124

No. 1R.



Elevators

Élévateurs
Heber
Elevatori
Elevadores
Elevadores
エレベーター

Oral Surgery Elevators

Straight. Overall length 6in (15.2cm).



MO11060

No. 0.



MO11070

No. 2.

MO11065

No. 1.

MO11065-R

No. 1. Reverse.



Oral Surgery Elevators

Angled. Overall length 6in (15.2cm).



MO11100

No. 73.

MO11105

No. 74.



POTTS-Type Exodontia Oral Surgery Elevators

Overall length 6in (15.2cm).



MO11110

No. 1. Right.

MO11115

No. 2. Left.

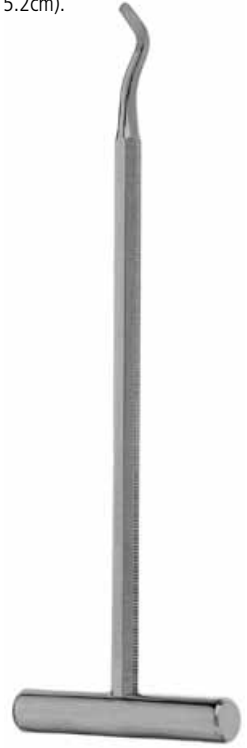

CRANE-Type Exodontia Oral Pick Elevator

Overall length 6in (15.2cm).



MO11075

Angled.



COGSWELL-Type Exodontia Oral Elevators

Overall length 6in (15.2cm).



MO11080

Straight.

MO11085

Angled.



CRYER-Type Exodontia Oral Surgery Elevators

Overall length 6in (15.2cm).



MO11090

No. 31.

MO11095

No. 32.



Periosteal Elevator

Overall length 7in (17.8cm).

**MO11120**

No. 856.

SELDIN-Type Periosteal Elevators

No. 23. Overall length 7-3/4in (19.7cm).

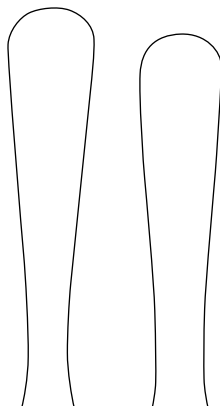
**MO11125**

Octagonal handle.

MO11130

Flat handle.

MOLT-Type Periosteal Elevator

Overall length 7-1/4in (18.4cm).

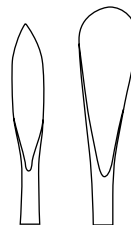
**MO11135**

No. 9.

Periosteal Elevator

Double-ended. Overall length 7in (17.8cm).

MO11138No. 9.
Round handle.**MO11140**No. 9H.
Hexagonal handle.**OBWEGESER-Type Periosteal Elevators**

Flat. Overall length 7in (17.8cm).

**MO9600**

Blade 6mm wide.

MO9602

Blade 7mm wide.

MO9604

Blade 9mm wide.

MO9608

Blade 11mm wide.

OBWEGESER-Type Mandibular Periosteal Elevators

Angled. Overall length 8in (20.3cm).

MO9615

Blade 5mm wide.

MO9616

Blade 8mm wide.

MO9617

Blade 9mm wide.

Elevators

Élévateurs
Heber
Elevatori
Elevadores
Elevadores
エレベーター

FREER-Type (Modified) Elevators

Double-ended. Sharp.
Overall length 8-1/2in (21.6cm).

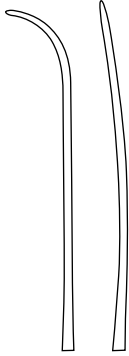

MO9620

Slightly curved.

MO9622

Strongly curved.



OBWEGESER-FREER-Type Periosteal Elevator

Double-ended. Blunt/Blunt.
Overall length 8-1/2in (21.6cm).

MO9690

Tip 6mm wide.



TESSIER-Type Periosteal Elevators

Blade 6mm wide.
Overall length 7in (17.8cm).



MO9692

Slightly curved.

MO9694

Fully curved.



Exodontia Oral Root Teasers

MO10000

No. 36. Extra-delicate. Serrated.
Overall length
7-1/4in (18.5cm).

MO10005

No. 37. Medium delicate.
Overall length
7-3/4in (19.7cm).

MO10010

No. 38. Heavy.
Overall length
7-1/2in (19cm).

MO10012

No. 3652.
Overall length
7-1/2in (19cm).



DAVIS-Type Exodontia Oral Root Teaser

Overall length 8in (20.3cm).

MO10015

No. 10.



Exodontia Oral Gauze Director and Ligature Tuckers

Overall length
7-1/4in (18.4cm).

MO10020

No. 2521.

MO10025

No. 2522.

Exodontia Oral Gauze Director and Ligature Tucker

Overall length
6-3/4in (17.1cm).

MO10030

Double-ended.



Sondes/Pics/Élévateurs
 Sonden/Picken/Heber
 Sonde/Becchi/Elevatori
 Sondas/Púas/Elevadores
 Sondas/Palhetas/Elevadores
 プローブ/ピック/エレベーター

Explorer Probes

MO11-17

No. 17. Overall length
 6in (15.2cm).

MO11-5

No. 5. Overall length
 6-1/4in (15.9cm).



Exodontia Oral Gauze Packer

Double-ended.
 Overall length
 7-3/4in (19.7cm).

MO10008

No. 2.



WEST Root Tip Pick

Overall length
 6-1/2in (16.5cm).

MO10018

No. 1.



SELDIN Root Pick

Double-ended.

MO10014

Overall length
 7-1/2in (19cm).



**CRONIN-Type Cleft
 Palate Elevator**

MO277

Medium. Blade
 12mm x 4.5mm wide.



GILLIES-Type Malar Elevator

Overall length 9in (22.9cm).

MO9625

Large handle.



Tooth Extractor Forceps

Davier dentaire
Zahnextraktionszange
Pinza per estrazione denti
Fórceps de extractores dentales
Fórceps de extractores dentários
拔齒用鉗子

Tooth Extractor

Lower incisor and bicuspid.
Overall length 6-1/2in (16.5cm).

MO11200

No. 151.

MO11-151A

No. 151A.

MO11-151AS

No. 151AS.

MO11-151X

No. 151X.

MO11-222

No. 222.



Exodontia Oral Surgery Extracting Forceps

Lower molar. Overall length
6-1/2in (16.5cm).

MO11205

No. 23.



Exodontia Oral Surgery Extracting Forceps

Lower molar. Overall length 6-1/2in (16.5cm).

MO11210

No. 17.



Upper Molar Extracting Forceps

Overall length 4-3/4in (12cm).

MO11-150C

No. 150C.



Lower Molar Extracting Forceps

Overall length 4-3/4in (12cm).

MO11-17C

No. 17C.



Molar Extracting Forceps

Lower anterior. Overall length 5-3/4in
(14.6cm).

MO11-74N

No. 74N.

MO11-74XN

No. 74XN.

MO11-151S

No. 151S.



Davier dentaire
Zahnextraktionszange
Pinza per estrazione denti
Fórceps de extractores dentales
Fórceps de extractores dentários
拔齒用鉗子

Lower Root Extracting Forceps

Overall length 5-3/4in (14.6cm).

MO11-06

No. 06.

MO11-33

No. 33.

MO11-74

No. 74.



Upper Molar Extracting Forceps

Overall length 6in (15.2cm).

MO11-150AS

No. 150AS.

MO11-150S

No. 150S.



Extracting Forceps

Overall length 6-1/4in (15.9cm).

MO11-101

No. 101.



NEVIUS Extracting Forceps

Overall length 6-3/4in (17.2cm).

MO11-10S

No. 10S.



Upper Anterior Molar Forceps

Overall length 6-3/4in (17.2cm).

MO11-MD1

No. MD1.

MO11-MD2

No. MD2.



Oral Extracting Forceps

Overall length 6in (15.2cm).

MO11-13

No. 13.

MO11-73

No. 73.

MO11-86

No. 86.

MO11-MD3

No. MD3.



Tooth Extractor Forceps

Davier dentaire
Zahnextraktionszange
Pinza per estrazione denti
Fórceps de extractores dentales
Fórceps de extractores dentários
拔齒用鉗子

Lower Molar Extracting Forceps

Overall length 6-1/2in (16.5cm).

MO11-16

No. 16.

MO11-203

No. 203.



English-Type Molar Extracting Forceps

MO11-22

No. 22.
Overall length
6in (15.2cm).

MO11-87

No. 87.
Overall length
6-1/2in (16.5cm).



Upper Molar Extracting Forceps

Anterior. Overall length 7in (17.8cm).

MO11-1

No. 1.

MO11202

No. 1A.

MO11280

No. 150.

MO11286

No. 150A.

MO11-150X

No. 150X.



Oral Molar Forceps

Upper. Overall length 7-1/4in (18.4cm).

MO110-10S

No. 10S.

MO11-18L

No. 18L.

MO11-53R

No. 53R.

MO11-53L

No. 53L.

MO11-69

No. 69.

MO11-286

No. 286.



Molar Extracting Forceps

Overall length 7-1/2in (19cm).

MO11-88R

No. 88R.

MO11-88L

No. 88L.

MO11-90

No. 90.



Root Extracting Forceps

Overall length 7-1/2in (19cm).

MO11-65

No. 65.



Forceps/Pince-gouge/Limes
Zangen/Rongeur-Zangen/Feilen
Pinze/Pinza ossivora/Lime
Fórceps/Fórceps de gubias/Limas
Fórceps/Pinça saca-bocado/Limas
鉗子/骨鉗子/やすり

Exodontia Rongeur

Overall length 5-3/4in (14.6cm).

MO9810

No. 260.



ROWE-Type Disimpaction Forceps

Overall length 9-1/2in (24.1cm).

MO9950

Left.

MO9955

Right.



TESSIER-Type Bone-Bending Forceps

Overall length 8-3/4in (22.2cm).

MO9960



HOWARD-Type Bone File

Overall length 7-1/4in (18.4cm).

MO10050

No. 12.



Oral Bone Files

Double-ended. Serrated.
Overall length 7-1/4in (18.4cm).

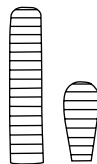

MO10055

One end 20mm x 5mm wide and one end 12mm x 3mm wide.

MO10060

One end 30mm x 7mm wide and one end 5mm rounded.



Oral Bone Files

Double-ended.
One end 5mm rounded and one end 7mm rounded.
Overall length 7-1/4in (18.4cm).

MO10065

Serrated.

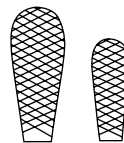

MO10070

Cross-serrated.



Oral Bone Files

Angled. Double-ended.

MO10052

Overall length 7-1/2in (19cm).



Rasps/Files

Rugines/Limes
Raspeln/Feilen
Raschietti/Lime
Raspadores/Limas
Raladores/Limas
石目やすり/やすり

Oral Bone Files

Double-ended.

MO10053

Cross-serrated.
Overall length
7in (17.8cm).

MO10054

Overall length
7-3/4in (19.7cm).



MILLER Rasp

Overall length
7-1/2in (19cm).

MO10056

No. 52.



WHAL Bone File

Double-ended.
Overall length
7-1/2in (19cm).

MO10057

Ends curved up
and curved down.



Dental Arch Bar

12 per package.

MO50

Overall length
5in (12.7cm).



**OBWEGESER-Type
Maxillary Awl**

Slightly curved.

MO9900

Overall length
7in (18cm).



**OBWEGESER-Type
Mandibular Awl**

Slightly curved.

MO9905

Overall length
5-1/2in (13.9cm).



BEUSE-Type Awl

Slightly curved.

MO9910

Overall length
9in (23cm).



OBWEGESER-Type Awl

MO9915

Overall length
9in (23cm).



**OBWEGESER-Type
Mandibular Awls**

Curved.

MO9920

Small. Overall length
6in (15.2cm).

MO9925

Large. Overall length
7-1/8in (18.1cm).

