

# Urology Instruments

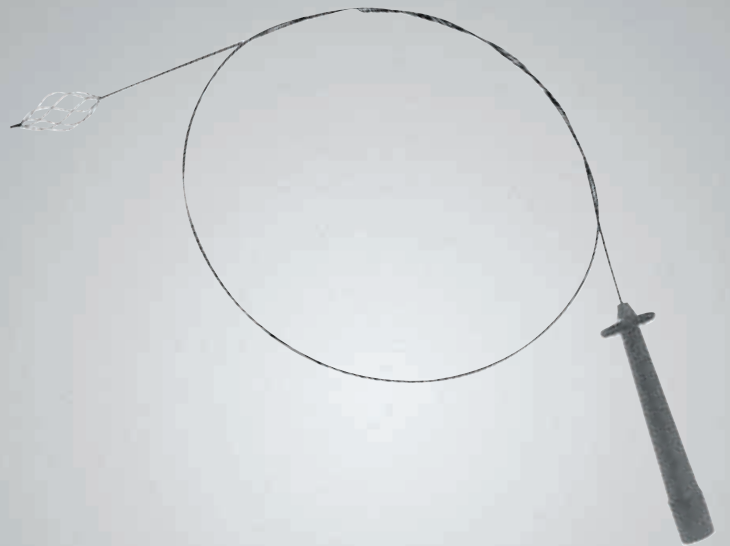

## Wire Mandrins/Bougies

Mandrins à fil/Bougies  
Drahtmandrine/Bougies  
Sonde guida/Candelette  
Mandriles para alambres/Sondas  
Veios de fios/Algálias  
ワイヤマンドリン/ブジー

### Wire Mandrins

Mirror finish.

#### GU3401

Guyon-Benique curve. 8Fr.  
Overall length  
16-3/4in (42.6cm).

#### GU3402

Van Buren curve. 6Fr.  
Overall length  
15-1/2in (40cm).

#### GU3403-004

Malleable tip. 4Fr.  
Overall length  
17-11/16in (44cm).

#### GU3403-006

Malleable tip. 6Fr.  
Overall length  
17-3/4in (43.2cm).



### OTIS Bougies a Boule

Olive tip. Mirror finish.

#### GU4005-008

8Fr.

#### GU4005-020

20Fr.

#### GU4005-032

32Fr.

#### GU4005-010

10Fr.

#### GU4005-022

22Fr.

#### GU4005-034

34Fr.

#### GU4005-012

12Fr.

#### GU4005-024

24Fr.

#### GU4005-036

36Fr.

#### GU4005-014

14Fr.

#### GU4005-026

26Fr.

#### GU4005-038

38Fr.

#### GU4005-016

16Fr.

#### GU4005-028

28Fr.

#### GU4005-040

40Fr.

#### GU4005-018

18Fr.

#### GU4005-030

30Fr.



### FRIEDMAN-OTIS Bougies a Boule

Three sizes of olive tips  
on one stem. Mirror finish.  
Overall length 7-7/8in (20cm).

#### GU4006-001

12, 14 and 16Fr.

#### GU4006-002

18, 20 and 22Fr.

#### GU4006-003

24, 26 and 28Fr.

#### GU4006-004

30, 32 and 34Fr.

#### GU4006-005

36, 38 and 40Fr.



### JEWETT Urethral Sounds

Straight. Mirror and Satin finish.  
Overall length 9-1/2in (24cm).

#### GU4060-012

12Fr.

#### GU4060-020

20Fr.

#### GU4060-028

28Fr.

#### GU4060-014

14Fr.

#### GU4060-022

22Fr.

#### GU4060-030

30Fr.

#### GU4060-016

16Fr.

#### GU4060-024

24Fr.

#### GU4060-032

32Fr.

#### GU4060-018

18Fr.

#### GU4060-026

26Fr.



**VAN BUREN Urethral Sounds**

Mirror and Satin finish. Overall length 10-5/8in (27cm).

<b>GU4010-008</b> 8Fr.	<b>GU4010-020</b> 20Fr.	<b>GU4010-032</b> 32Fr.
<b>GU4010-010</b> 10Fr.	<b>GU4010-022</b> 22Fr.	<b>GU4010-034</b> 34Fr.
<b>GU4010-012</b> 12Fr.	<b>GU4010-024</b> 24Fr.	<b>GU4010-036</b> 36Fr.
<b>GU4010-014</b> 14Fr.	<b>GU4010-026</b> 26Fr.	<b>GU4010-038</b> 38Fr.
<b>GU4010-016</b> 16Fr.	<b>GU4010-028</b> 28Fr.	<b>GU4010-040</b> 40Fr.
<b>GU4010-018</b> 18Fr.	<b>GU4010-030</b> 30Fr.	

**OTIS Urethral Sounds**

Mirror finish. Overall length 11in (28cm).

<b>GU4020-012</b> 12Fr.
<b>GU4020-014</b> 14Fr.
<b>GU4020-016</b> 16Fr.
<b>GU4020-018</b> 18Fr.
<b>GU4020-020</b> 20Fr.
<b>GU4020-022</b> 22Fr.
<b>GU4020-024</b> 24Fr.
<b>GU4020-026</b> 26Fr.
<b>GU4020-028</b> 28Fr.

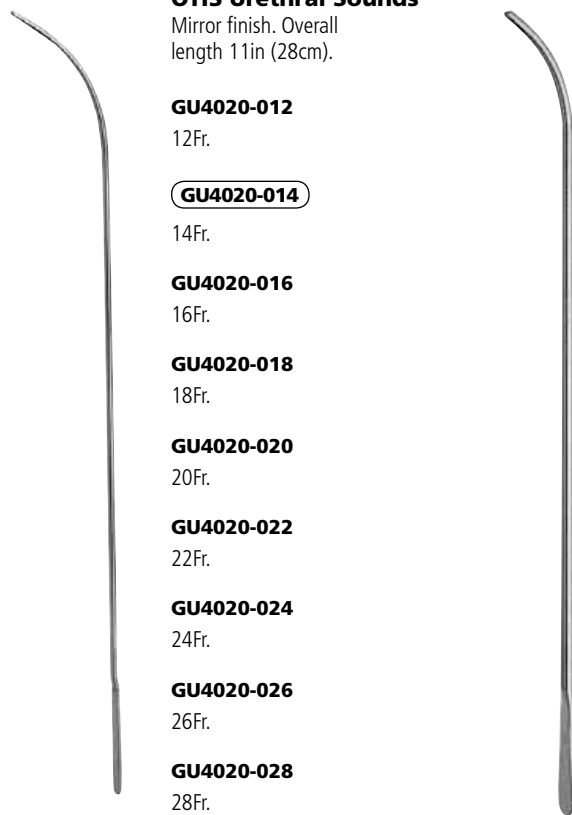

**WALTHER Urethral Sounds**

Tapered smaller toward handle. Mirror finish. Overall length 9-1/2in (24cm).

<b>GU4030-014</b> 14 Fr.	<b>GU4030-024</b> 24 Fr.
<b>GU4030-016</b> 16 Fr.	<b>GU4030-026</b> 26 Fr.
<b>GU4030-018</b> 18 Fr.	<b>GU4030-028</b> 28 Fr.
<b>GU4030-020</b> 20 Fr.	<b>GU4030-030</b> 30 Fr.
<b>GU4030-022</b> 22 Fr.	

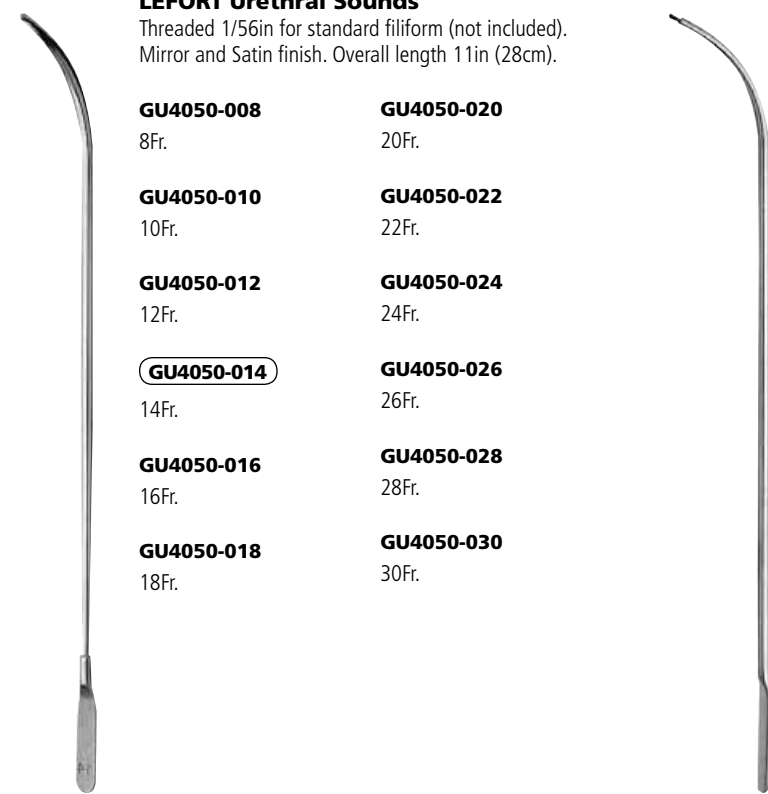

**LEFORT Urethral Sounds**

Threaded 1/56in for standard filiform (not included). Mirror and Satin finish. Overall length 11in (28cm).

<b>GU4050-008</b> 8Fr.	<b>GU4050-020</b> 20Fr.
<b>GU4050-010</b> 10Fr.	<b>GU4050-022</b> 22Fr.
<b>GU4050-012</b> 12Fr.	<b>GU4050-024</b> 24Fr.
<b>GU4050-014</b> 14Fr.	<b>GU4050-026</b> 26Fr.
<b>GU4050-016</b> 16Fr.	<b>GU4050-028</b> 28Fr.
<b>GU4050-018</b> 18Fr.	<b>GU4050-030</b> 30Fr.

## Sounds

Sondes  
Harnröhrenbougies  
Sonde  
Sondas  
Sons  
サウンド

### CAMPBELL Miniature Sounds

Short rounded tip. Mirror finish.  
Overall length 9-1/2in (24cm).

#### GU4080-006

6Fr.

#### GU4080-008

8Fr.

#### GU4080-010

10Fr.

#### GU4080-012

12Fr.

#### GU4080-014

14Fr.

#### GU4080-016

16Fr.

#### GU4080-018

18Fr.

#### GU4080-020

20Fr.

#### GU4080-022

22Fr.



### McCREA Female Sounds

Mirror and Satin finish. Overall length 7-5/8in (19.4cm).

#### GU4090-008

8Fr.

#### GU4090-010

10Fr.

#### GU4090-012

12Fr.

#### GU4090-014

14Fr.

#### GU4090-016

16Fr.

#### GU4090-018

18Fr.

#### GU4090-020

20Fr.

#### GU4090-022

22Fr.

#### GU4090-024

24Fr.

#### GU4090-026

26Fr.

#### GU4090-028

28Fr.

#### GU4090-030

30Fr.

#### GU4090-032

32Fr.

#### GU4090-034

34Fr.

#### GU4090-036

36Fr.



### OTIS Urethrotome

Straight, with three guide tips  
and two knife blades in wood  
case. Threaded 1/56in for  
filiform (not included).  
Mirror and Satin finish.

#### GU4140

Working length  
8-7/8in (22.5cm).  
Overall length  
11-3/4in (30cm).

#### GU4141

Replacement blade.



### DAVIS Interlocking Sounds

Mirror finish.

#### GU8100

Set of two. One male and one  
female sound. Overall length  
10-3/4in (27.3cm).



### Looking for a specific product?

When you know the catalog number or the name of the product you need, you can use the index at the end of this book to direct you to the page on which the product is described. If you do not find the specific instruments you are looking for, please contact your local V. Mueller sales representative or Customer Support at **800.323.9088**.

Cathéters/Canules  
 Katheter/Kanülen  
 Cateteri/Cannule  
 Catéteres/Cánulas  
 Cateteres/Cânulas  
 カテーテル/カニューレ

### Customer Support

Our highly trained, centralized V. Mueller customer support team is available to take your calls from 7:00 a.m. to 6:00 p.m. (CST), M-F. This group is dedicated to providing a full range of support services, including:

- Order placement
- Order inquiries
- Delivery information
- Product information
- Pricing inquiries

If we can be of assistance, please call us at **800.323.9088**.

### Female Catheters

14Fr. Mirror finish.  
 Overall length  
 6in (15.2cm).

**GU4230**

Chrome Plated.

**GU4232**

Silver.

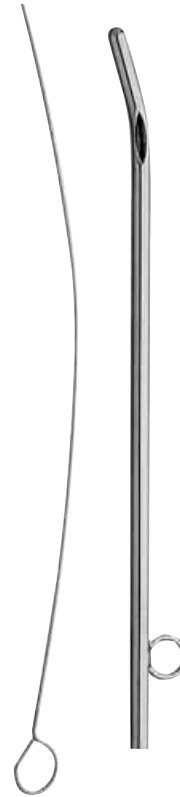

### CAMPBELL Suprapubic Trocar and Cannula

Cannula graduated in centimeters, grooved to accommodate 20Fr. FOLEY catheter.  
 Size 26Fr.  
 Working length 5-7/8in (15cm).  
 Chrome Plated.

**GU4290**

Size 26Fr.  
 Working length  
 5-7/8in (15cm).

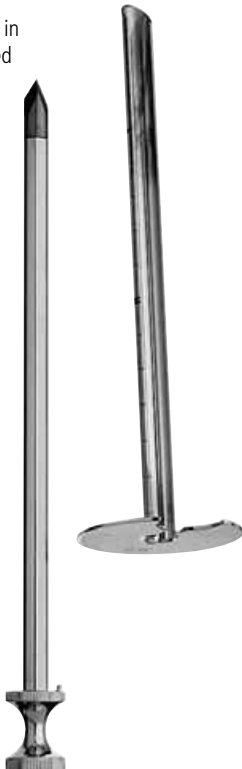

### BRODNY Urethrographic Clamp and Cannula

Matte, Mirror and Satin finish.

**GU3920**

Rubber acorn tip and small metal tip (syringe not included). Cannula overall length 8-1/4in (21cm).



### Silicone Rubber Acorn Tip

Attaches to syringe or irrigator for bladder and urethral irrigations.

**GU4360**

Standard size.  
 Overall length  
 1-1/16in (2.7cm).



## Stone Baskets

Paniers à calcul  
Steinkörbe  
Cestelli per calcoli  
Cestas extractoras de cálculos  
Cestas de cálculos  
ストーンバスケット

### PFISTER-SCHWARTZ Stone Retrievers

Sterile, for single use only.

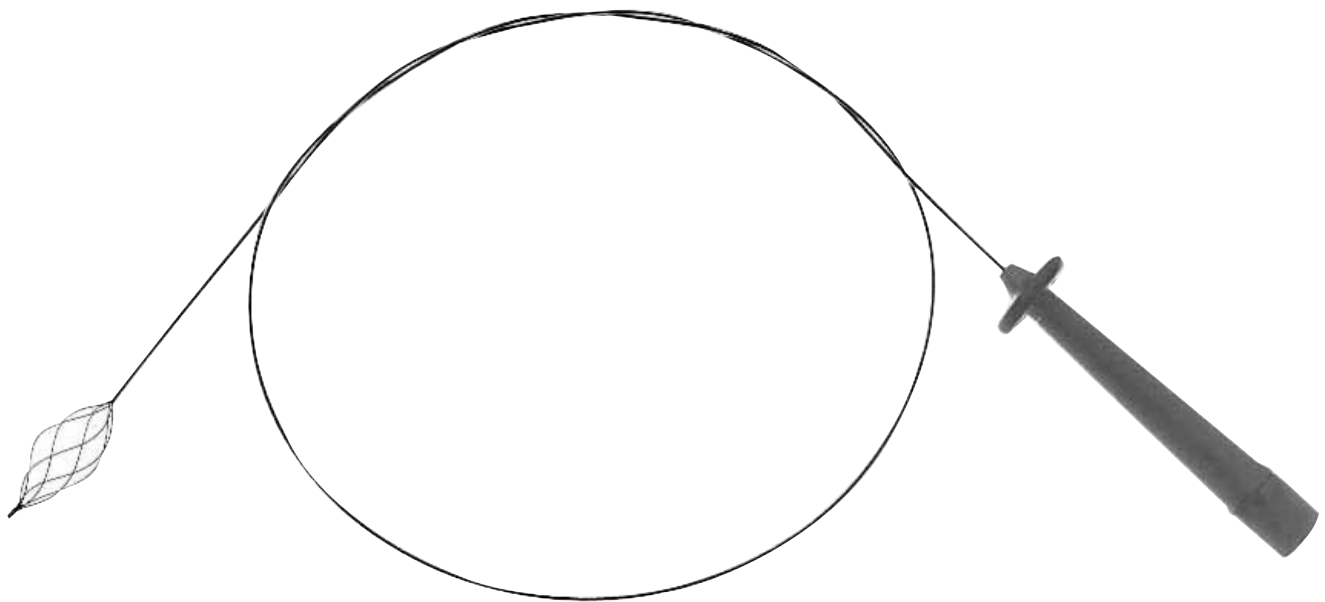

Without Filiform	With Filiform	Cable Size	Cable Length	Number of Wires	Basket Size
<b>GU6390</b>		3Fr.	110cm	3	8mm
<b>GU6392</b>		3Fr.	110cm	3	11mm
<b>GU6394</b>		3Fr.	110cm	3	15mm
<b>GU6395</b>		3Fr.	110cm	4	8mm
<b>GU6397</b>		3Fr.	110cm	4	11mm
<b>GU6399</b>		3Fr.	110cm	4	15mm
<b>GU6361</b>		4Fr.	110cm	6	8mm
<b>GU6365</b>		4Fr.	110cm	6	11mm
<b>GU6369</b>		4Fr.	110cm	6	15mm
<b>GU6371</b>		4Fr.	110cm	4	8mm
<b>GU6375</b>		4Fr.	110cm	4	11mm
<b>GU6379</b>		4Fr.	110cm	4	15mm
<b>GU6351</b>	<b>GU6350</b>	4Fr.	70cm	6	8mm
<b>GU6355</b>	◆ <b>GU6354</b>	4Fr.	70cm	6	11mm
<b>GU6359</b>	<b>GU6358</b>	4Fr.	70cm	6	15mm
<b>GU6381</b>	<b>GU6380</b>	4Fr.	70cm	4	8mm
<b>GU6385</b>	<b>GU6384</b>	4Fr.	70cm	4	11mm
<b>GU6389</b>	<b>GU6388</b>	4Fr.	70cm	4	15mm

Forceps/Clamps  
Zangen/Klemmen  
Pinze/Morse  
Fórceps/Pinças  
鉗子/クランプ

**ALYEA Vas Clamp**

Circular jaws have  
5 x 6 dull teeth.

**GU8130**

Overall length  
6in (15.2cm).



**LEADER Vas Isolation Forceps**

Useful in fixation  
for anesthesia.

**GU8150**

Ball tips.  
Overall length  
5-1/4in (13.3cm).



**LEADER Vas Hook**



**GU8152**

Corkscrew tip,  
12mm wide.  
Overall length  
6-1/4in (16cm).



**SANDERS Vasectomy Forceps**

**GU8156**

Overall length  
6-1/8in (15.6cm).



**No-Scalpel Vasectomy Fixator  
Ring Clamp**

Blunt tips.

◆ **GU8160**

Overall length  
5-1/2in (14cm).



**No-Scalpel Vasectomy Forceps**

Sharp-pointed smooth jaw. Curved.



**GU8161**

Overall length  
5in (12.5cm).

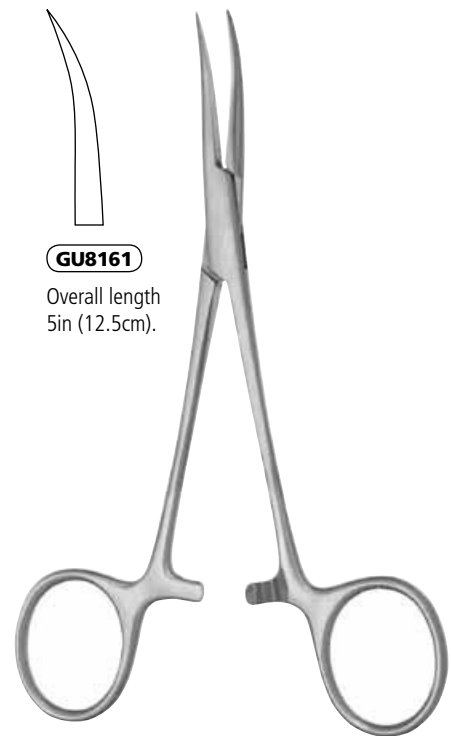

## Needle Holders/Forceps

Porte-aiguilles/Forceps  
Nadelhalter/Zangen  
Porta-ago/Pinze  
Sostenes de agujas/Fórceps  
Porta-agulhas/Fórceps  
針ホルダー/鉗子

### COBB-RAGDE Needles

COBB-RAGDE needle prongs are slightly malleable, and angled 40°. Tapered edges are non-cutting and inner edges of needle eyes are rounded. Mirror and Satin finish. Overall length 10in (25.4cm).

#### GU4590

Set of two needles.

#### GU4590-001

One needle.



### SILBER Micro Needle Holder

Round-handled for manipulation.



#### GU8170

Curved, delicate jaws.  
Without lock, but with stop.  
Overall length 5-1/2in (14cm).



### SILBER Clamp Set

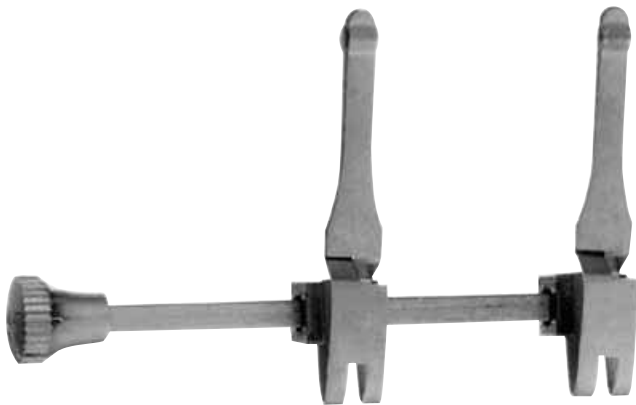

#### GU8172

Set is complete with one micro vise and two micro clamps.

### SILBER Microvascular Clamp Set

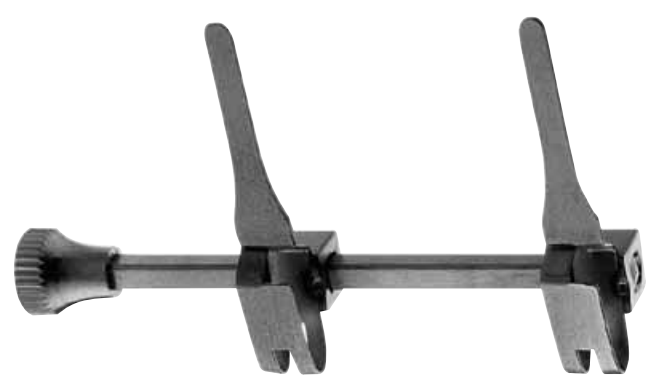

#### GU8174

The set consists of one micro vise and two micro clamps.



Écarteurs  
Wundspreizer/Retraktoren  
Divaricatori  
Separadores  
Retradores  
リトラクター

**YOUNG Lateral Retractor**

Narrow blade, grooved.

**GU8350**

Blade 2in x 7/16in  
(5.1cm x 1.1cm) wide.  
Overall length  
8-1/4in (21cm).

**YOUNG Bulb Retractor**

Curved blade, notched to go around urethra.

**GU8355**

Blade 1in x 1in  
(2.5cm x 2.5cm).  
Overall length  
8-5/8in (22cm).

**RANKIN Prostate Retractor**

Slightly curved, flat blade.

**GU8360**

Blade 2in x 7/8in  
(5.1cm x 2.2cm) wide.  
Overall length  
9in (22.9cm).

**YOUNG Anterior Retractors**

Acute angle. Overall length  
7-5/8in (19.5cm).

**GU8365**

Blade 2-3/8in x 1-1/2in  
(6cm x 3.8cm) wide.

**GU8366**

Blade 3in x 1-5/8in  
(7.6cm x 4.1cm) wide.

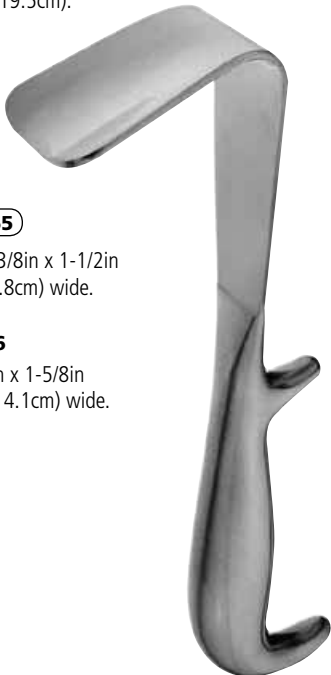
**PHIEFER-YOUNG Retractor****GU8370**

Blade 2in x 1in  
(5.1cm x 2.5cm) wide.  
Overall length  
9-1/4in (23.5cm).

**YOUNG Bifid Retractor**

Deep-slotted blade has rounded ends.

**GU8375**

Blade 1-1/2in x 1-5/8in  
(3.8cm x 4cm) wide.  
Overall length  
7-7/8in (20cm).



## Retractors

Écarteurs  
Wundspreizer/Retraktoren  
Divaricatori  
Separadores  
Retratores  
リトラクター

### JACOBSON Bladder Retractor

Deep, swivel-mounted side blades are replaceable by a pair of similar shorter blades. Center blade is interchangeable with a malleable silver-plated solid blade. The retractor is readily convertible for the other procedures simply by using solid center blade. Notched crossbar is resistant to slip. Mirror and satin finish.

#### GU8200

Complete with fenestrated center blade, two long and two short open lateral blades. Crossbar 7-1/4in (18.5cm). Long blade depth 4-3/4in (12cm). Short blade depth 4in (10cm). Arm length 5-3/8in (13.6cm).

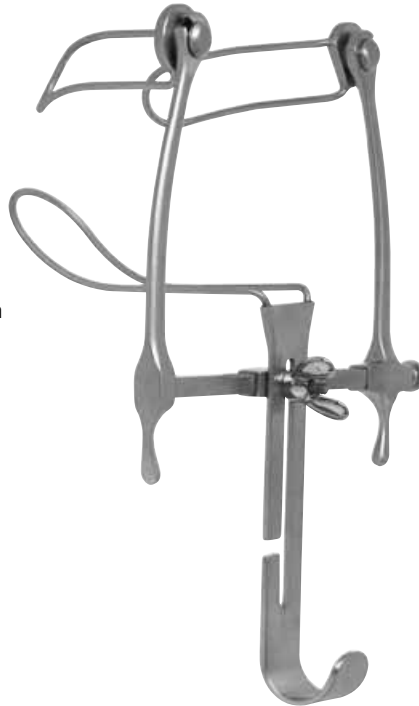

Due to changing surgical trends, some products described in this catalog may be discontinued. Your V. Mueller sales representative may be able to suggest a suitable substitute if one is available.

### MASSON-JUDD Bladder Retractor

#### GU8212

Self-retaining, with two swivel blades. Crossbar 6-5/8in (16.8cm). Blade depth 3in (6.9cm). Arm length 5-1/8in (13cm).

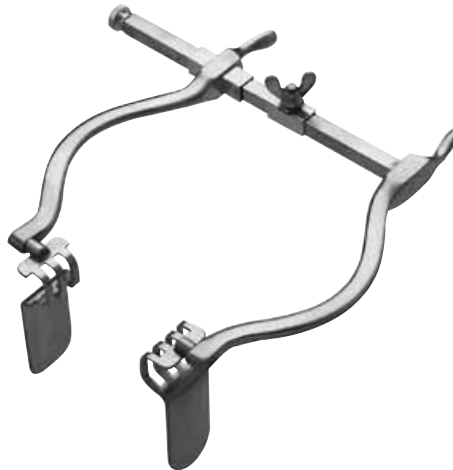

### WYLIE Vein Retractors

#### GU8300

Short. Blade 4in x 1in (10cm x 2.5cm) wide. Overall length 12-1/4in (31.2cm).

#### GU8305

Long. Blade 7in x 1in (17.7cm x 2.5cm) wide. Overall length 12-1/2in (31.5cm).

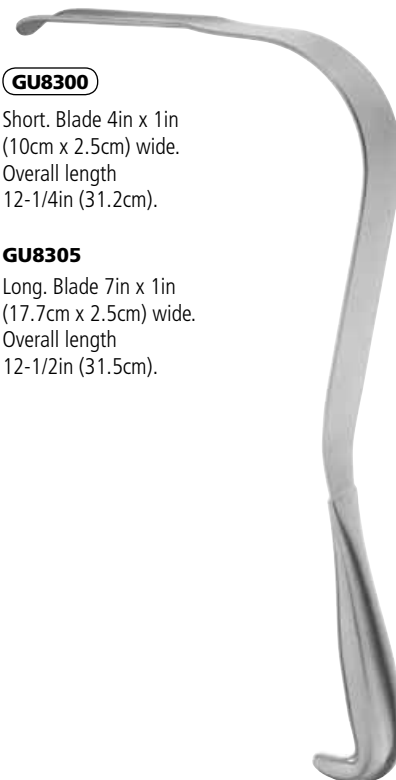

**SCOTT Dissecting Scissors**

Mirror finish.



**GU8290**

Angled blade.  
Overall length  
7in (17.8cm).

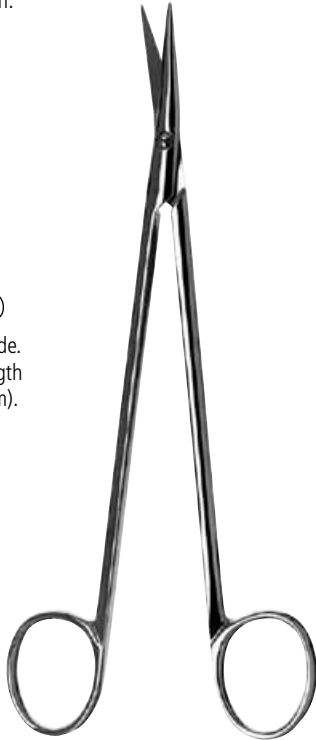

**SCOTT Right Angle Scissors**

Mirror finish.

**GU8292**

Fully curved blades.  
Overall length  
9in (22.9cm).

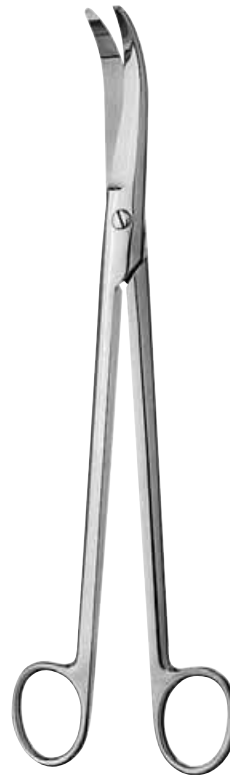

**YOUNG Prostatic Tractors**

**GU8385**

Long model.  
Overall length  
13-1/2in (34.3cm).

**GU8386**

Short model. Overall length  
8-5/8in (21.7cm).

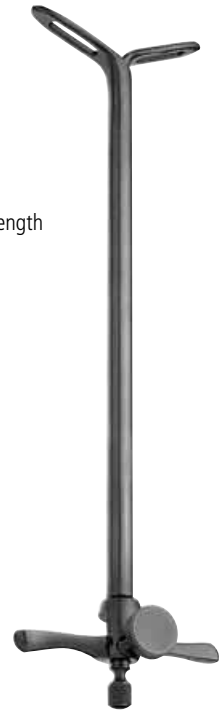

**LOWSLEY Prostatic Tractors**

Caliber 20Fr.

◆ **GU8390**

Curved.  
Working length  
9-3/4in (25cm).  
Overall length  
13in (33cm).

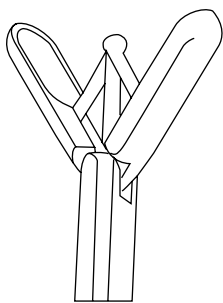

**GU8391**

Straight.  
Working length  
9in (23cm).  
Overall length  
12-1/4in (31cm).



**LOWSLEY Prostatic Holding Forceps**

**GU8410**

Overall length  
10in (25.4cm).



**MYERS Prostatic Forceps**

Jaws angled 35°.  
Overall length  
9-1/2in (24.1cm).

**GU8600**



## Retractors/Clamps

Écarteurs/Clamps  
Wundspreizer/Retraktoren/Klemmen  
Divaricatori/Morse  
Separadores/Pinças  
Retradores/Pinças  
リトラクター/クランプ

### MILLIN-BACON Retropubic Prostatectomy Retractors

#### GU8500

Malleable center blade. Two sets of swivel blades in 2in (5.1cm) and 2-1/2in (6.3cm) depths are interchangeable on the side arms. Crossbar 18.5cm.



#### GU8501

Solid, malleable center blade. Length 5-1/2in (14cm), depth 2-3/8in (6cm), width 2-3/8in (6cm).

#### GU8502-001

Side blades. Pair. Overall length 2in (5.1cm).

#### GU8502-002

Side blades. Pair. Overall length 2-1/2in (6.3cm).

### MILLIN T-Shaped Angled Forceps

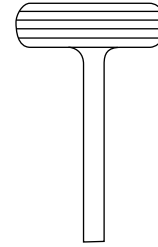

#### GU8550

Overall length 9-1/4in (23.5cm)

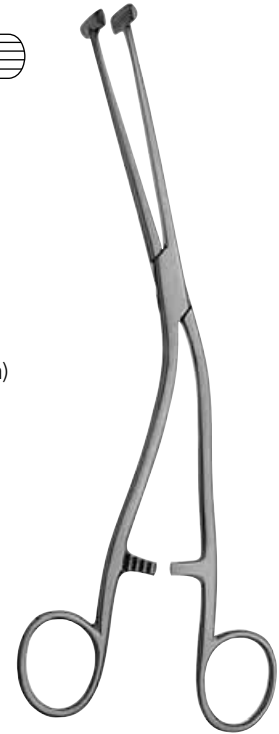

### MILLIN Capsule-Grasping Forceps



#### GU8560

Overall length 9-1/4in (23cm).



### HARRIS Angled Suture-Carrying Forceps

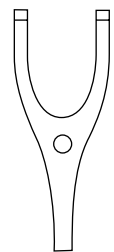

#### GU8590

Overall length 9-1/2in (24.1cm).

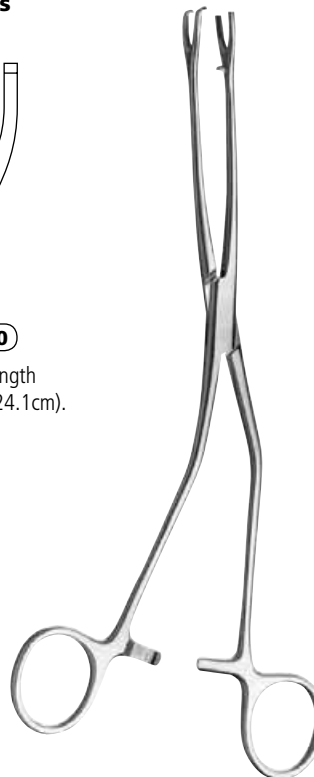

### McDOUGAL-Type Clamps

Overall length 10-1/2in (26.7cm).

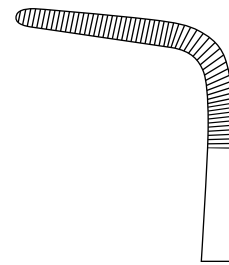

#### GU8605

Angled left.

#### GU8606

Angled right.

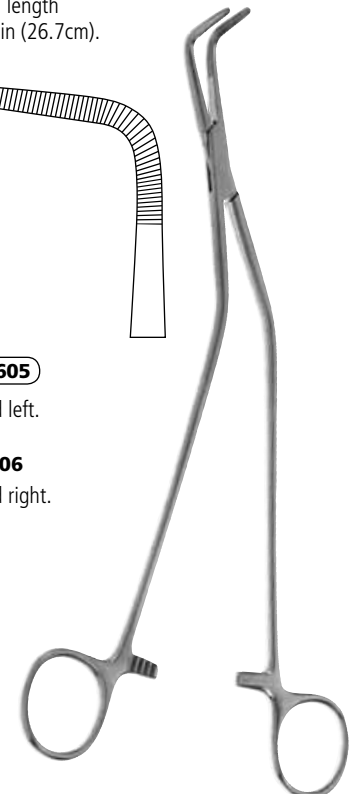

Porte-aiguilles/Clamps  
 Nadelhalter/Klemmen  
 Porta-ago/Morse  
 Sostenes de agujas/Pinzas  
 Porta-agulhas/Pinças  
 針ホルダー/クランプ

**JOHNSON Prostatic Needle Holder**

Angled jaws with one grooved, serrated side and one heavy cross-serrated side.

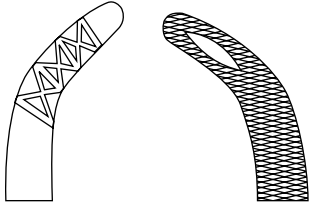

**GU8610**

Angled shanks. Overall length 11-5/8in (29.2cm).

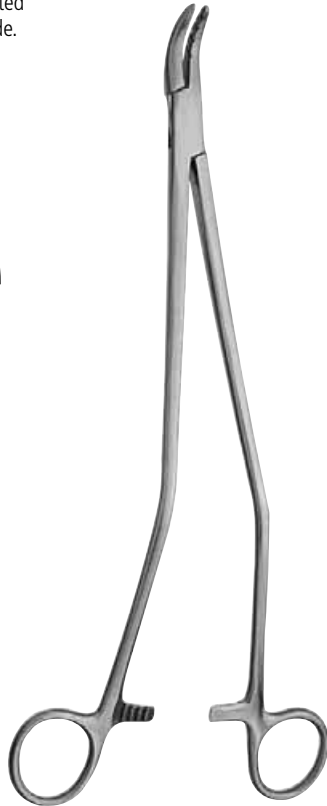

**YOUNG-MILLIN Boomerang Needle Holders**

Rear heel plate and suture hook. Complete with two needles, 10in (25.4cm). Small and large sizes. Chrome and Nickel Plated.

**GU8580**

Overall length 8-1/2in (does not include needle).

**GU8581-001**

Replacement needle only. Small.

**GU8581-002**

Replacement needle only. Large.

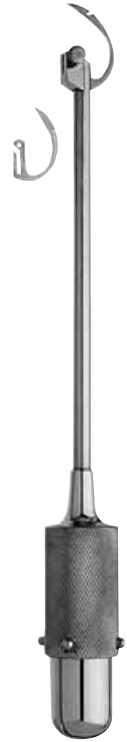

**HERRICK Kidney Pedicle Clamp**

Double-angled, serrated jaws. Heavy model.

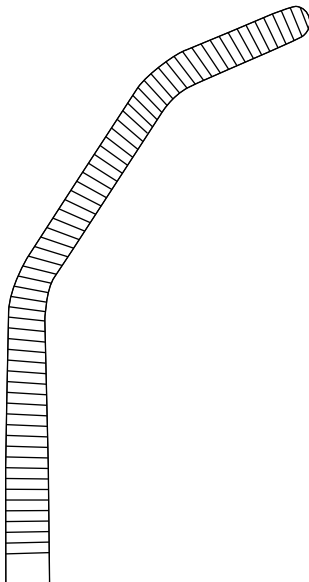

**GU8790**

Overall length 9-1/2in (24.1cm).

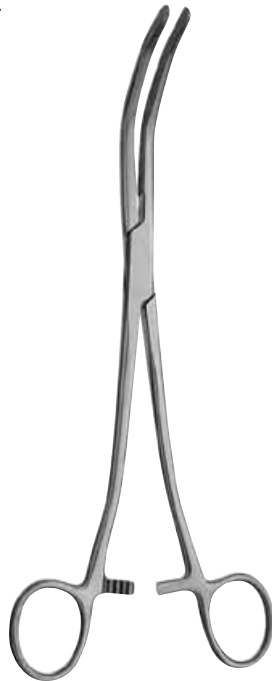

**WALTHER Kidney Pedicle Clamp**

Serrated jaws, longitudinal ridge and groove.

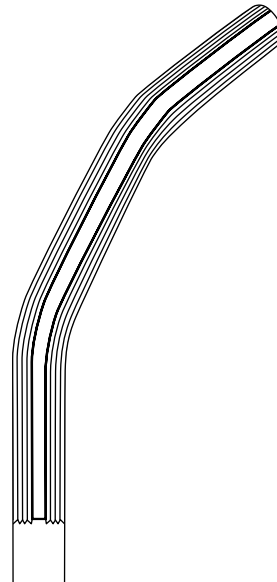

**GU8820**

Overall length 9-3/4in (24.8cm).



**Forceps/Clamps**

Forceps/Clamps  
Zangen/Klemmen  
Pinze/Morse  
Fórceps/Pinças  
Fórceps/Pinças  
鉗子/クランプ

**RANDALL Kidney Stone Forceps**



◆ **GU8740**  
Quarter curved, No. 1.  
Overall length 9in (23cm).

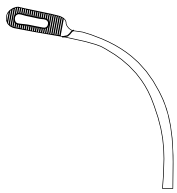

**GU8741**  
Half curved, No. 2.  
Overall length 8-1/4in (21cm).

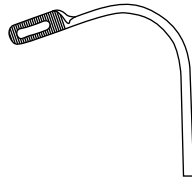

**GU8742**  
Three-quarter curved, No. 3.  
Overall length 8in (20.3cm).

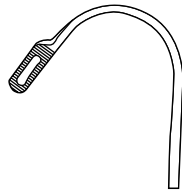

**GU8743**  
Fully curved.  
Overall length 8in (20.3cm).



**V. Mueller Instrument Detergents**

To assist with the care and handling of your instruments, CareFusion offers you a full line of cleaning and decontamination products detailed in the Genesis Sterilization Containers and Instrument Processing Supplies section of this armamentarium.

**YOUNG Renal Pedicle Clamp**

Long, curved jaws have longitudinal serrations. Edges of jaws are cut away obliquely on the concave and convex sides.

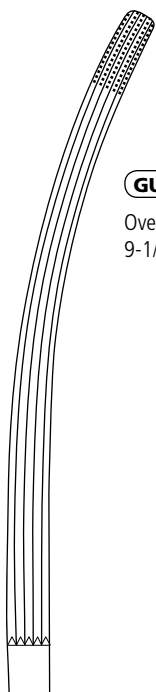

◆ **GU8840**  
Overall length  
9-1/4in (23.5cm).



**GUYON-PEAN Vessel Clamp**

Full double-curved blades with horizontal serrations.

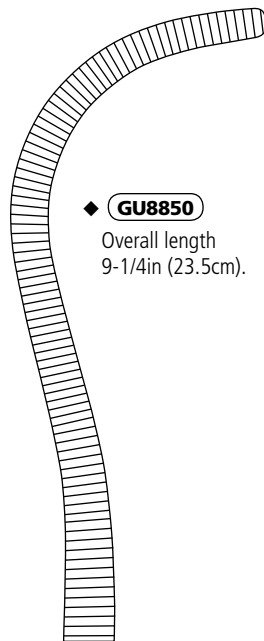

◆ **GU8850**  
Overall length  
9-1/4in (23.5cm).



**GIL-VERNET Retractors****GU8770**

Blade 9mm wide.  
Overall length  
9-1/2in (24.1cm).

**GU8771**

Blade 11mm wide.  
Overall length  
9-1/2in (24.1cm).

**GU8772**

Blade 13mm wide.  
Overall length  
9-3/4in (24.8cm).

**GU8773**

Blade 15mm wide.  
Overall length  
9-3/4in (24.8cm).

**GU8774**

Blade 19mm wide.  
Overall length  
9-3/4in (24.8cm).

**GIL-VERNET Retractors**

Malleable shaft. Overall length 11-1/4in (28.6cm).

**GU8775**

Blade 9mm wide.

**GU8776**

Blade 11mm wide.

**GU8777**

Blade 13mm wide.

**GU8778**

Blade 15mm wide.

**GU8779**

Blade 18mm wide.

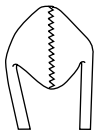
**HENDREN Ureteral  
Clamp****GU8690**

Overall length  
8in (20.3cm).

**CAMPBELL Ureteral  
Catheter Forceps**

Thumb forceps have  
modified tips with  
opposing hemi-cylindrical  
grasping cups angled 45°.

**GU8720**

Cup length 1cm.  
Overall length  
8in (20.3cm).



For more than 115 years, the V. Mueller® name has been known worldwide as a leading developer, manufacturer and provider of high-quality surgical instruments. As part of CareFusion, V. Mueller® instrumentation continues to offer innovative surgical instruments, including a broad selection of laparoscopic instruments to satisfy your minimally invasive surgical instrument needs.

## Clamps/Needles

Clamps /Aiguilles  
Klemmen/Nadeln  
Morse/Aghi  
Pinzas /Agujas  
Pinças/Agulhas  
クランプ/針

To learn how the IMPRESS system can help improve process performance, reduce immediate-use steam sterilization, decrease case delays, and improve patient care by monitoring instrument flow within your facility, contact your V. Mueller sales representative.

### TURNER WARWICK Needles

Mirror and Satin finish.

**GU8260-007**

Fully curved.  
Overall length  
7-1/2in (19.1cm).

**GU8260-008**

Half curved.  
Overall length  
7-5/8in (19.5cm).

**GU8260-009**

Quarter curved.  
Overall length  
7-3/4in (19.8cm).



### Diathermy Cord for TURNER WARWICK Instruments

**GU8260-020**

12ft (365cm) long.



### TATUM Meatus Clamp

**GU4550**

Opens to 1-1/2in  
(3.8cm) minimum.

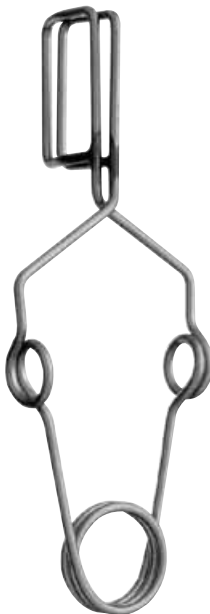

### HYAMS Meatus Clamp

**GU4560**



### ZIPSER Meatus Clamp

**GU4570**

Overall length  
4-1/4in (10.8cm).

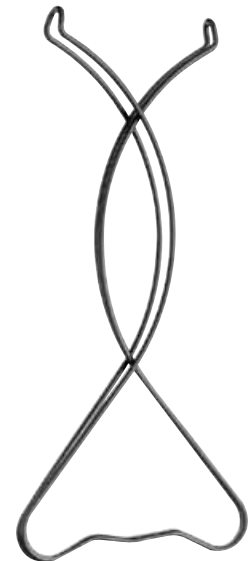



Forceps/Clamps  
Zangen/Klemmen  
Pinze/Morse  
Fórceps/Pinças  
Fórceps/Pinças  
鉗子/クランプ

**BLACK Meatus Clamp**

Mirror finish.

**GU4575**



**WHITVER Penile Clamp**

For retaining liquid anesthetic.  
Mirror finish.

**GU4580**

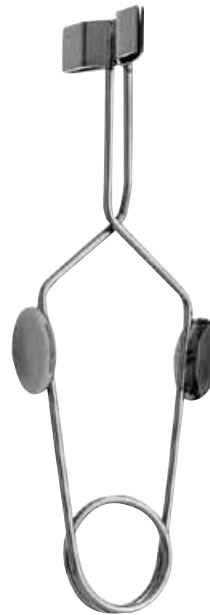

**WALTER CRENSHAW Meatus Clamp**



**GU8180**

Working length  
2in (5cm).  
Overall length  
6-1/4in (15.5cm).



**TOOMEY Bladder Evacuators**

Glass syringe-type.  
Metal catheter adapter.

**GU7650**

Graduated,  
30cc capacity.  
Nickel Plated and  
Matte finish.

**GU7656**

Graduated,  
50cc capacity.  
Chrome Plated  
and Matte finish.



**CUNNINGHAM Incontinence Clamps**

Padded and lightweight, with  
a rubber covered malleable  
metal frame.

**HS7552**

Small size, with snap  
button catch.



**HS7554**

Regular size,  
with ratchet catch.

**HS7556**

Large size,  
with ratchet catch.

**BAUMRUCKER Urinary Incontinence Clamp**

Contains no metal parts and  
VELCRO® material to aid  
secure closure.

**HS7560**



**BAUMRUCKER Post TUR Irrigation Clamp**

Holds both supply and drain  
tubes, compressing one and  
allowing the other to run free.

**HS3840**

Overall length  
3-1/2in (8.9cm).



