

OB/GYN Instruments

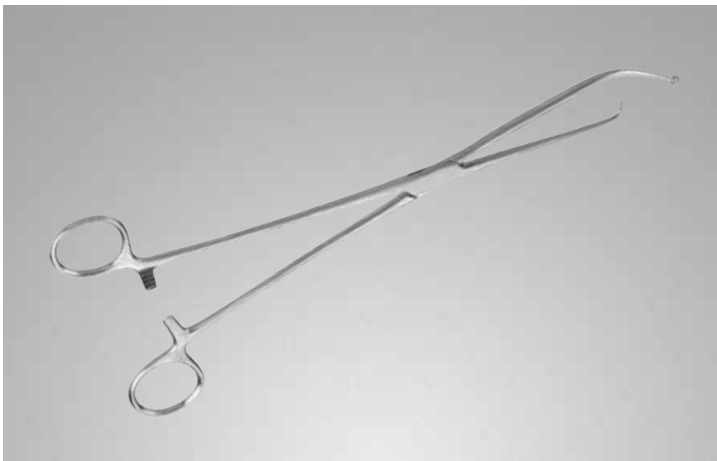
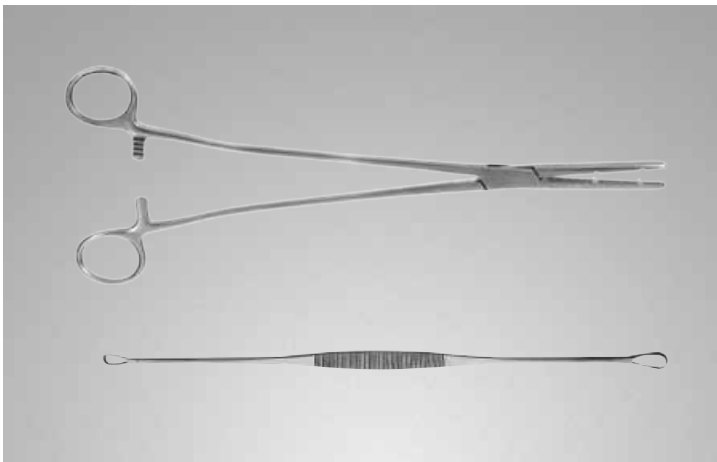

Specula

Spéculum
Spekula
Speculum
Espéculos
Espéculos
檢鏡

GRAVES Vaginal Specula

Mirror finish.



GL10

Small. Blade 3in x 3/4in wide
(7.6cm x 1.9cm).

GL11

Medium. Blade 4in x 1-3/8in wide
(10.2cm x 3.5cm).

GL12

Large. Blade 4-1/2in x 1-3/8in wide
(11.5cm x 3.5cm).

GL14

Extra-large. Blade 6in x 1-1/2in (15.2cm x 3.8cm).

GL15

Double XL. Blade 7in x 1-1/2in (17.8cm x 3.8cm).

GRAVES Improved Vaginal Specula

Mirror finish.



GL16

Small. 3in x 3/4in wide
(7.6cm x 1.9cm).

GL17

Medium. 4in x 1-3/8in wide
(10.2cm x 3.5cm).

GL18

Large. 4-1/4in x 1-5/16in wide
(10.8cm x 3.5cm).

GRAVES Open Side Vaginal Speculum

Mirror finish.



GL25

Medium, with ratchet lock.
4in x 1-5/16in wide
(10.2cm x 3.4cm).

GRAVES Speculum with Suction

With permanent smoke evacuation tube.



GL20

Large. Blade
4-1/2in x 1-3/8in wide
(11.4cm x 3.5cm).

PEDERSON Vaginal Specula

Mirror finish.

GL30Small. 3in x 1/2in wide
(7.6cm x 1.3cm).◆ **GL31**Medium. 4in x 7/8in wide
(10.2cm x 2.2cm).**GL32**Large. 4-1/2in x 1-1/16in wide
(11.4cm x 2.6cm).**PETERSON Vaginal Speculum**

With permanent smoke evacuation tube.

GL33Large. Blade
4-3/4in x 1in wide
(12.1cm x 2.5cm).**GUTTMANN Vaginal Specula**

Matte and Mirror finish.

GL210Solid center blade.
3-1/2in x 1-3/16in wide
(8.9cm x 3cm).**GL220**Fenestrated center blade.
3-1/2in x 1-3/16in wide
(8.9cm x 3cm).**HUFFMAN-GRAVES Vaginal Speculum****GL34**4-5/16in x 9/16in wide
(11cm x 1.4cm).

Specula

Spéculum
Spekula
Speculum
Espéculos
Espéculos
檢鏡

KAHN-GRAVES Vaginal Speculum

Mirror finish.

GL55

4-5/16in x 1-3/8in wide (11cm x 3.5cm).



Vaginal Specula

Single-bladed.

Overall length 9in (23cm).

GL40

Medium.

GL42

Large.



HUFFMAN Infant Vaginoscope

Partially Chrome Plated.

GL170

Working length
2-9/16in (6.5cm).



KOGAN Endospeculum

Fenestrated blades and finger rings bent outward in opposite directions. Spring-closed blades open when finger rings are pressed together. Blade length 7/8in (21mm). With gauge.

GL750

Overall length
9-3/4in (24.8cm).



GARRIGUE Vaginal Speculum

Weighted. Mirror finish.

◆ **GL250**Blade 3in x 1-9/16in wide
(7.6cm x 4cm).**AUVARD Vaginal Specula**

Weighted. Mirror finish.

◆ **GL258**Blade 3-3/8in x 1-1/4in wide
(8.6cm x 3.2cm).◆ **GL259**Blade 4in x 1-1/4in wide
(10.2cm x 3.2cm).**STEINER Speculum**

Weighted. Mirror finish.

◆ **GL260**Blade 5-1/2in x 1-1/4in
(14.1cm x 3.2cm) wide.**TAUBER Vaginal Spatula**◆ **GL450**Blade 3-1/2in x 1-3/8in wide
(8.9cm x 3.5cm). Overall length
9-1/4in (23.5cm).

Specula/Retractors

Spéculum/Écarteurs
 Spekula/Wundspreizer/Retraktoren
 Speculum/Divaricatori
 Espéculos/Separadores
 Espéculos/Retratores
 検鏡/リトラクター

BREISKY-NAVRATIL Vaginal Specula

Mirror and Satin finish. Overall length 12in (30.5cm).

GL460

Blade 3-15/16in x 3/4in wide (10cm x 1.8cm).

◆ GL461

Blade 3-15/16in x 1in wide (10cm x 2.5cm).

GL462

Blade 3-15/16in x 1-3/16in wide (10cm x 3cm).

GL463

Blade 4-3/8in x 1-3/8in wide (11.1cm x 3.5cm).

GL464

Blade 3-15/16in x 1-1/2in wide (10cm x 3.8cm).

GL465

Blade 4-3/4in x 1-3/16in wide (12cm x 3cm).

GL466

Blade 5-1/8in x 1-3/8in wide (13cm x 3.5cm).

GL467

Blade 5-1/2in x 1-3/8in wide (14cm x 3.5cm).

◆ GL469

Blade 6-1/4in x 1-3/8in wide (16cm x 3.5cm).

◆ GL470

Blade 6-11/16in x 1in wide (17cm x 2.5cm).



MATZENAUER Vaginal Speculum

Mirror and Satin finish.

GL475

Blade 4-5/16in x 1in wide
 (11cm x 2.5cm).
 Overall length
 12-3/8in (31.5cm).



MATZENAUER Vaginal Specula

GL486

Blade 4-3/4in x 1-1/2in
 wide (12cm x 3.8cm).



SIMS Vaginal Specula

Double-ended.

GL300

Blade
 1in x 1-1/16in wide
 (2.5cm x 2.6cm).

GL301

Blade
 1-1/16in x 1-3/16in wide
 (2.6cm x 3cm).

GL302

Blade
 1-3/16in x 1-7/16in wide
 (3cm x 3.6cm).



EASTMAN Vaginal Retractors

Overall length 6-7/8in (17.5cm).

GL420

Small. Blade
 3in x 1-1/2in wide
 (7.6cm x 3.8cm).

GL421

Medium. Blade
 3-1/2in x 1-1/2in wide
 (8.9cm x 3.8cm).

GL422

Large. Blade
 4in x 1-1/2in wide
 (10.2cm x 3.8cm).



DOYEN Vaginal Retractors

GL431

Blade 3-3/4in x 1-3/4in wide
 (9.5cm x 4.7cm). Overall length
 8-3/4in (22.0cm).

GL432

Blade 5in x 1-3/4in wide
 (12.9cm x 4.4cm). Overall length
 8-1/2in (21.6cm).

GL434

Blade 4in x 2-3/8in wide
 (9.8cm x 6cm). Overall length
 9-1/4in (23.4cm).

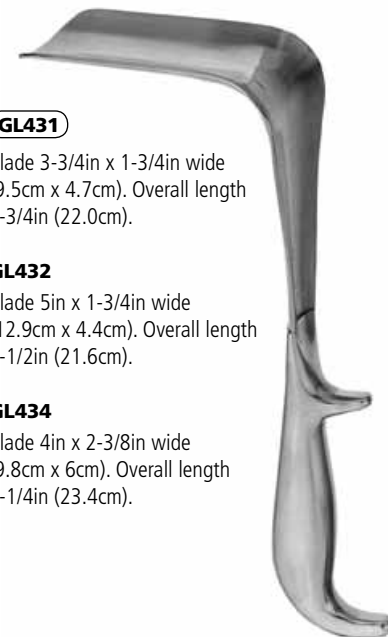

DE LEE Universal Retractor◆ **GL480**

Blade 2-3/4in x 2in wide
(7cm x 5.1cm). Overall length
9-1/2in (24.1cm).

**DE LEE Corner Retractors**

Blade 2-3/4in x 2in wide.
Overall length 10in (25.5cm).

GL481

Right.

GL482

Left.

**JACKSON Vaginal Retractors**

Overall length 6-7/8in (17.5cm).

GL410

Small. Blade 3in x 1-1/2in wide (7.6cm x 3.8cm).

GL411

Medium. Blade 3-1/2in x 1-1/2in wide (8.9cm x 3.8cm).

GL412

Large. Blade 4in x 1-1/2in wide (10.2cm x 3.8cm).

**SIMS Vaginal Retractors****GL310**

Blade 2-3/4in x 1in wide (7cm x 2.5cm).

GL311

Blade 3in x 1-1/4in wide (7.6cm x 3.2cm).

GL312

Blade 3-1/2in x 1-1/2in wide (8.9cm x 3.8cm).



Retractors

Écarteurs
Wundspreizer/Retraktoren
Divaricatori
Separadores
Retratores
リトラクター

KELLY-SIMS Vaginal Retractor

GL320

Blade 2-1/4in x 1in wide
(5.7cm x 2.5cm).



HEANEY-SIMON Retractor

GL350

Blade 4-1/2in x 1in wide
(11.5cm x 2.5cm). Overall length
10-1/2in (26.7cm).



HEANEY Retractors

Overall length 6-3/4in (17.1cm).

GL390

Small. Blade 1-3/4in x 1in wide
(4.4cm x 2.5cm).

GL391

Medium. Blade 2-7/8in x 1-1/8in wide
(7.3cm x 2.8cm).

GL392

Large. Blade 3-1/4in x 1-1/8in wide
(8.3cm x 2.8cm).



GLENNER Retractor

GL360

Blade 5-1/4in x 1in wide
(13.3cm x 2.5cm). Overall length
10-5/8in (27cm).



Écarteurs
Wundspreizer/Retraktoren
Divaricatori
Separadores
Retratores
リトラクター

Lateral Wall Retractors

For use inside vaginal speculum.
Open shanks.

GL440

Blade length 2-1/2in (6.4cm).
Overall length 9in (23cm).

GL442

Blade length 3-1/2in (8.9cm).
Overall length 10in (25cm).

GL444

Blade length 4-1/2in (11.4cm).
Overall length 11in (28cm).

**Lateral Wall Retractor**

For use inside vaginal speculum.
Closed shanks.

GL446

Blade length 2-1/2in (6.4cm).

**Redundant Wall Retractors**

For use outside vaginal speculum.
Overall length 7in (18cm).

GL448

Blade length 3in (7.6cm).

GL449

Blade length 5in (12.6cm).

**RIGBY Vaginal Retractor**

Smooth, solid, self-retaining blades.
With ratchet lock.

GL560

Overall length
7-1/2in (19cm).



Retractors

Écarteurs
Wundspreizer/Retraktoren
Divaricatori
Separadores
Retratores
リトラクター

GUTTMANN Obstetrical Retractor

Synchronous three-way movement.
Self-retaining.

GL570

Blade 2-3/4in x 9/16in wide
(7cm x 1.5cm).



O'SULLIVAN-O'CONNOR Vaginal Speculum

GL200

Interchangeable center blades:
One each 3-1/2in x 1-3/4in wide
(9cm x 4.4cm).
One each 3-1/2in x 1-1/4in wide
(9cm x 3.2cm).
One each 1-3/4in x 3/4in wide
(4.4cm x 1.9cm).
Permanent side blades:
Two each 1-3/4in x 3/8in wide
(4.4cm x 1cm).



SMITH Vaginal Retractor

Self-retaining. The angle and counter-traction of the blades serve to hold the retractor securely in place.



GL530

Ring is 9in (23cm) in diameter; three identical right-angled retractors with blades 4in x 1-3/4in wide (10.2cm x 4.4cm).
Blades have 8in (20.3cm) handles.

V. Mueller Instrument Detergents

To assist with the care and handling of your instruments, CareFusion offers you a full line of cleaning and decontamination products detailed in the Genesis Sterilization Containers and Instrument Processing Supplies section of this armamentarium.

Aiguilles/Crochets
Nadeln/Haken
Aghi/Uncini
Agujas/Ganchos
Agulhas/Ganchos
針/フック

DESCHAMPS-NAVRATIL Ligature Needles

Mirror and Satin finish.
Overall length
8-11/16in (22cm).

GL1220

Curved left for the right hand.

GL1222

Curved right for the left hand.



NICHOLS-DESCHAMPS-NAVRATIL Ligature Needles

Overall length
11-7/16in (29cm).

GL1223

Curved left for the right hand.

GL1224

Curved right for the left hand.



BRAUN Ligature Carrier

Mirror and Satin finish.

GL1240

Right-angle hook.
Overall length
9-1/2in (24.1cm).



PEREYRA Improved Ligature Cannula

Mirror finish.

GL3750

Overall length
10-3/4in (27.3cm).



EMMETT Tenaculum Hooks

Overall length 9in (22.9cm).



GL800

Style No. 1. Sharp.



GL802

Style No. 3. Sharp.



GL803-001

Style No. 4. Blunt.



GL800-001

Style No. 1. Blunt.



GL802-001

Style No. 3. Blunt.



GL804

Style No. 5. Sharp.



GL801

Style No. 2. Sharp.



GL803

Style No. 4. Sharp.



GL804-001

Style No. 5. Blunt.



IUD Removal Hook

Malleable.
Overall length
10-1/4in (26cm).

GL1875



Needle Holders/Scissors

Porte-aiguilles/Ciseaux
 Nadelhalter/Scheren
 Porta-ago/Forbici
 Sostenes de agujas/Tijeras
 Porta-agulhas/Tesoura
 針ホルダー/鉋

**BOZEMAN-WERTHEIM
 Needle Holder**

Bayonet.



SU16130

Overall length
 9-1/2in (24.1cm).

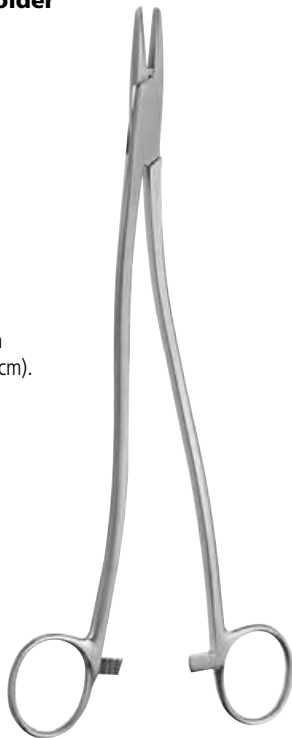

KELLY Uterine Scissors

Short blades. Sharp/Sharp. Mirror finish.
 Overall length 6-1/4in (15.9cm).

GL3420

Straight.

GL3421

Curved.

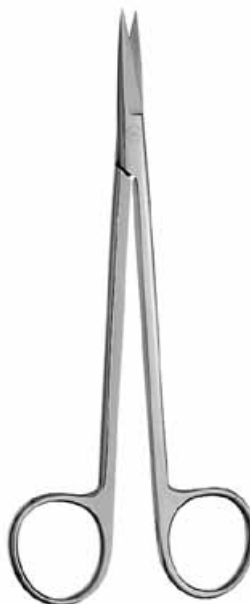

SIMS Uterine Scissors

Straight. Mirror finish.
 Overall length 8in (20.3cm).

GL3400

Sharp/Blunt.

GL3401

Blunt/Blunt.

GL3402

Sharp/Sharp.

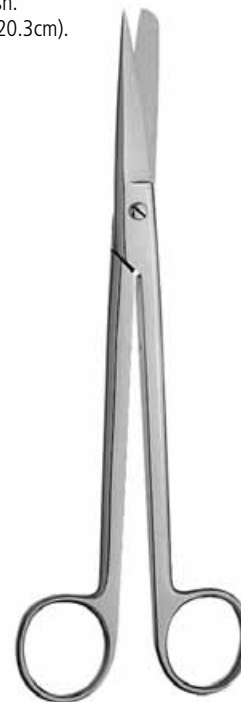

SIMS Uterine Scissors

Curved. Mirror finish.
 Overall length 8in (20.3cm).

GL3405

Sharp/Blunt.

GL3406

Blunt/Blunt.

GL3407

Sharp/Sharp.



Vital® Uterine Scissors

Stellite® cutting edges.

GL3450

Slightly curved blades.
 Overall length
 9in (23cm).

GL3450-001

Strongly curved blades.
 Overall length
 9in (23cm).

GL3450-002

Angulated blades.
 Overall length
 9in (23cm).

GL3452

Slightly curved blades.
 Overall length
 10-1/2in (26.5cm).

GL3452-001

Strongly curved blades.
 Overall length
 10-1/2in (26.5cm).

GL3452-002

Angulated blades.
 Overall length
 10-1/2in (26.5cm).

GL3454

Slightly curved blades.
 Overall length
 12in (30cm).

GL3454-001

Strongly curved blades.
 Overall length
 12in (30cm).

GL3456

Slightly curved blades.
 Overall length
 14in (35cm).

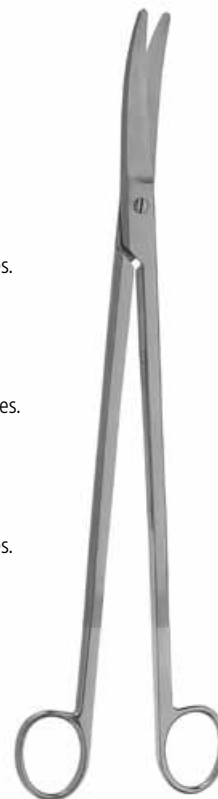

Ciseaux/Forceps
Scheren/Zangen
Forbici/Pinze
Tijeras/Fórceps
Tesoura/Fórceps
鉗/鉗子

BRAUN Episiotomy Scissors

Angled. Mirror finish.

GL3500

Overall length
5-1/2in (14cm).



WALDMANN Episiotomy Scissors

Curved, slight serrations.
Mirror finish.

GL3510

Overall length
7in (18cm).



SCHROEDER Episiotomy Scissors

Heavy. Straight. Sharp/Blunt.
Mirror finish.

GL3480

Overall length
8-1/4in (21cm).



AMERICAN Pattern Umbilical Scissors

Straight.

GL3550

Overall length
4in (10.2cm).



MOYNIHAN-NAVRATIL Forceps

Angled.

GL3260

Overall length
7-7/8in (20cm).

GL3262

Overall length
9-1/2in (24cm).

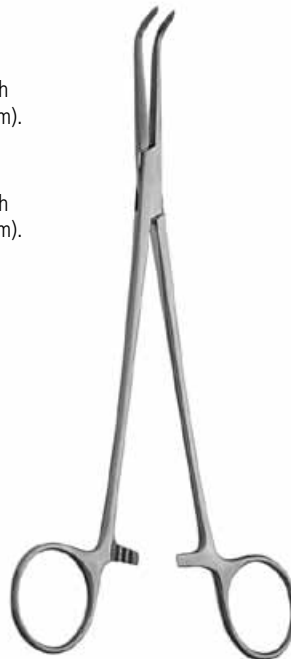

BOZEMAN Uterine Packing Forceps

Curved.
Overall length
10in (25.4cm).

GL600

GL600-MM
Mueller-Mirror®
finish.



OB/GYN

Forceps

Forceps
Zangen
Pinze
Fórcps
Fórcps
鉗子

DE LEE Uterine Packing Forceps

Curved.

GL620

Overall length
11-1/4in (28.7cm).



BARRETT Uterine Tenaculum Forceps

Straight.

GL860

Overall length
7-1/8in (18.1cm).



BRAUN Uterine Tenaculum Forceps

Straight.

◆ **GL850**

Overall length
9-1/2in (24.1cm).



DE LEE Cervix Holding Forceps

Straight. Serrated.

GL680

Overall length
9-1/2in (24.1cm).



GUTGLASS Cervix Hemostatic Forceps

Straight, serrated.

GL685

Overall length
9-3/4in (24.5cm).



BIERER Ovum Forceps

Overall length 11in (27.9cm).

GL5712

Jaws 12mm wide.
Serrated fine jaws.
Without ratchet.

GL5714

Jaws 14mm wide.
Serrated fine jaws.
Without ratchet.

GL5716

Jaws 16mm wide.
Large teeth.
With ratchet.

GL5719

Jaws 19mm wide.
Large teeth.
With ratchet.

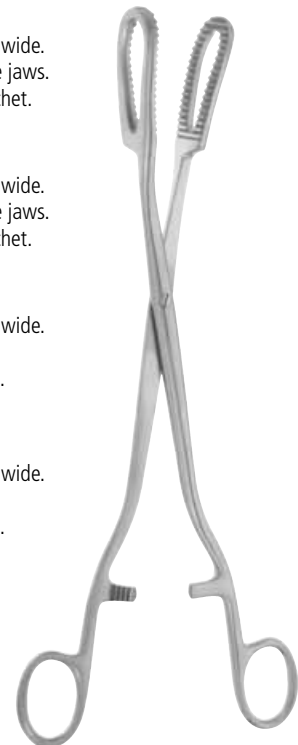

SKENE Uterine Tenaculum Forceps

Curved on side.

GL900

Overall length
9-5/8in (24.4cm).



GORDON Uterine Vulsellum Forceps

Straight. 3 x 3 prongs.

GL1070

Overall length
8-3/4in (22.2cm).



JACOB Uterine Vulsellum Forceps

2 x 2 teeth. Overall length 8-1/4in (21cm).

GL950

Straight.

GL952
Curved on side.



HENROTIN Uterine Vulsellum Forceps

Straight. 2 x 3 teeth.

GL970

Overall length
8-1/4in (21cm).



SOMERS Uterine Elevating Forceps

Curved, serrated, fenestrated jaws. Mirror finish.

GL3010

Overall length
8-3/4in (22.2cm).



Forceps

Forceps
Zangen
Pinze
Fórceps
Fórceps
鉗子

BUXTON Uterine Clamp

Swivel jaws.

GL3025

Overall length
9-3/4in (24.8cm).



HULKA-KENWICK Uterine Elevating and Manipulating Forceps

◆ **GL3030**

Overall length
10-3/4in (27.3cm).



HULKA Single Tooth Tenaculum Forceps

Overall length
11-1/2in (29.2cm).

GL3035



COLLIER-ANDERSON Clamps

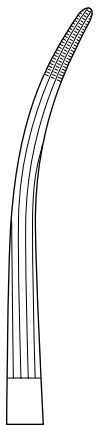

GL3292

Overall length
14in (35.6cm).



Customer Support

Our highly trained, centralized V. Mueller customer support team is available to take your calls from 7:00 a.m. to 6:00 p.m. (CST), M-F. This group is dedicated to providing a full range of support services, including:

- Order placement
- Order inquiries
- Delivery information
- Product information
- Pricing inquiries

If we can be of assistance, please call us at **800.323.9088**.

ROCHESTER-CARMALT Hysterectomy Forceps

Longitudinal serrations.

GL3220

Straight.
Overall length
9in (22.9cm).

GL3221

Straight.
Overall length
10-1/8in (25.8cm).

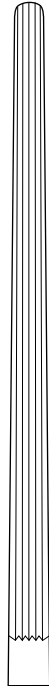

GL3230

Curved.
Overall length
9in (22.9cm).

GL3231

Curved.
Overall length
10in (25.4cm).

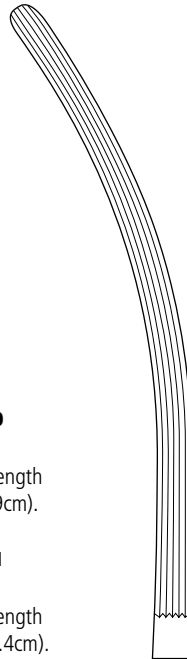

HEANEY Hysterectomy Forceps

Curved, biased serrations.

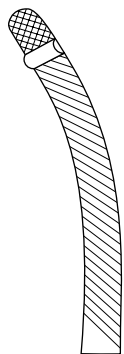

◆ **GL3100**

Overall length
8-1/4in (21cm).



HEANEY-REZEK Hysterectomy Forceps

Straight, criss-cross serrations.



GL3101

Overall length
8-1/4in (21cm).



Forceps/Clamps

Forceps/Clamps
Zangen/Klemmen
Pinze/Morse
Fórceps/Pinças
Fórceps/Pinças
鉗子/クランプ

HEANEY-KANTER Hysterectomy Forceps

Curved. Additional wide tooth.

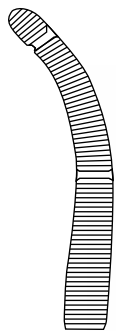

GL3110

Overall length 8-1/4in (21cm).

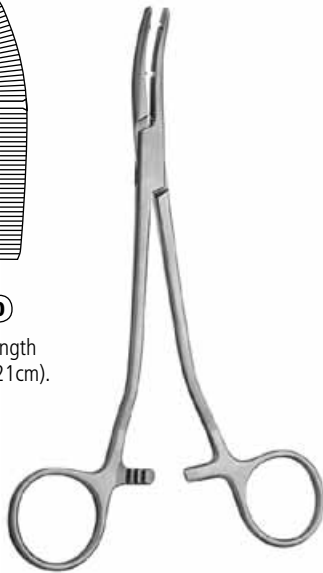

HEANEY-BALLENTINE Hysterectomy Forceps

Curved, longitudinal grooves.



◆ **GL3120**

Overall length 8-1/4in (21cm).

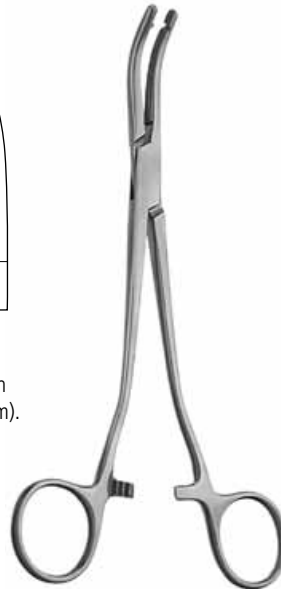

BALLENTINE Hysterectomy Forceps

Straight, longitudinal grooves.



◆ **GL3121**

Overall length 8-1/4in (21cm).



BALLENTINE-PETERSON Hysterectomy Forceps

Curved. Longitudinal grooves, 1 x 2 teeth.

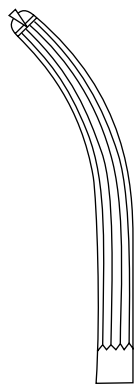

GL3125

Overall length 8-1/2in (21.6cm).



GLENNER Uterine Forceps

Overall length 8-1/4in (21cm).

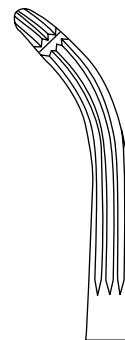

GL3122-001

Curved left for patient's right.

GL3122-002

Curved right for patient's left.



REICH-NECHTOW Uterine Forceps

Overall length 8-1/4in (21cm).

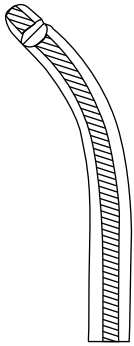

GL3130

Curved.

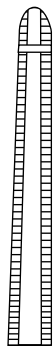

GL3131

Straight.



LONG Uterine Forceps

Slightly curved. 1 x 2 teeth.

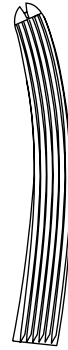

GL3140

Overall length
7-1/2in (19.1cm).



GELPI Hysterectomy Forceps

Curved, deep serrations. 1 x 2 teeth.

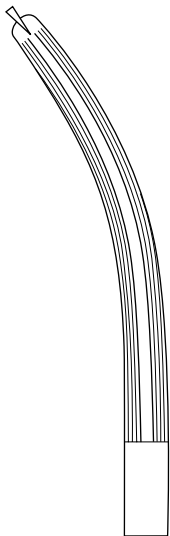

GL3160

Overall length
9in (22.6cm).



HEANEY Hysterectomy Forceps

Overall length 12in (30.5cm).

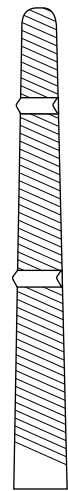

GL3123

Straight.

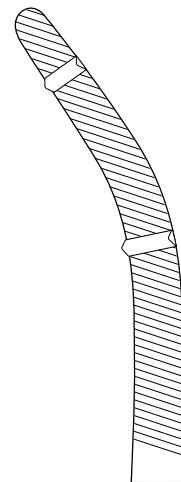

GL3124

Curved.



Forceps/Clamps
Zangen/Klemmen
Pinze/Morse
Fórceps/Pinças
Fórceps/Pinças
鉗子/クランプ

ROGERS Hysterectomy Forceps

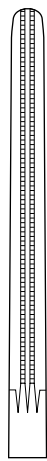

GL3190
Straight.
Overall length
10in (25.4cm).

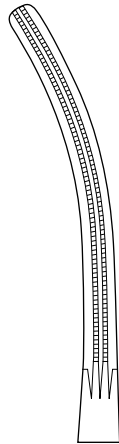

GL3191
Curved.
Overall length
10in (25.4cm).

GL3188
Straight.
Overall length
8-1/2in (21.6cm).

GL3189
Curved.
Overall length
8-1/2in (21.6cm).



Looking for a specific product?

When you know the catalog number or the name of the product you need, you can use the index at the end of this book to direct you to the page on which the product is described. If you do not find the specific instruments you are looking for, please contact your local V. Mueller sales representative or Customer Support at **800.323.9088**.

MASTERSON Hysterectomy Forceps

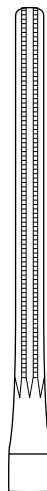

GL3268
Straight.
Overall length
8-1/2in (21.6cm).

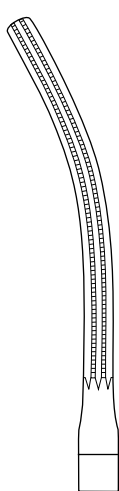

GL3269
Curved.
Overall length
8-1/2in (21.6cm).

GL3270
Straight.
Overall length
10in (25.4cm).

GL3271
Curved.
Overall length
10in (25.4cm).

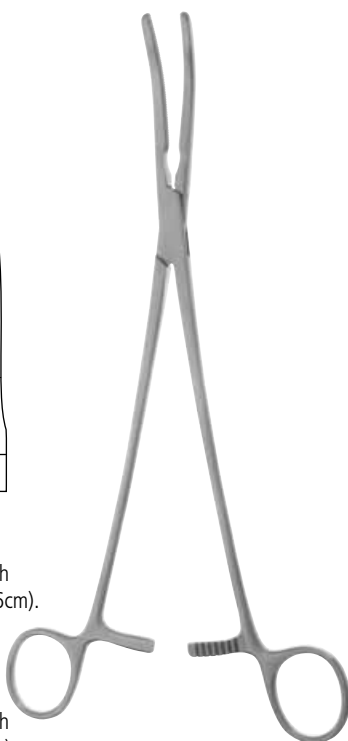

CLARK Hysterectomy Clamps

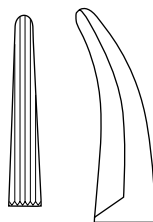

GL3310
Overall length 12in (30.5cm).

GL3311
Overall length 14in (35.6cm).



Z-Type Hysterectomy Clamps

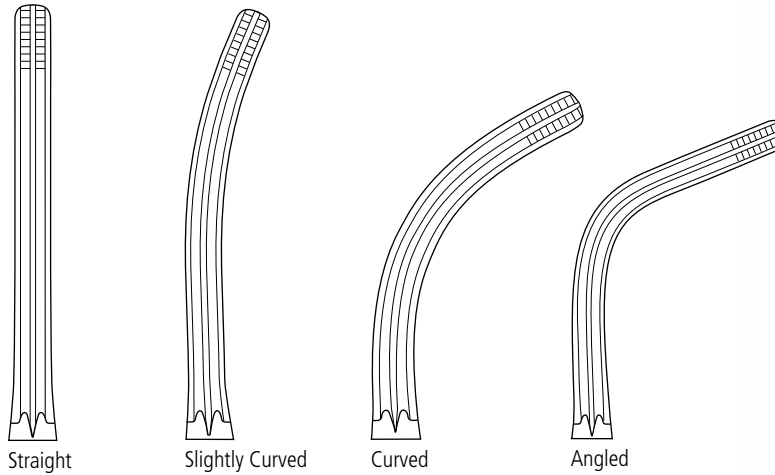

Straight Handle Overall Length	Straight Jaws	Slightly Curved Jaws	Curved Jaws	Angled Jaws
8-1/2in (21.6cm)	GL3600-001	GL3600-002	GL3600-003	GL3600-004
9-1/2in (24cm)	◆ GL3602-001	◆ GL3602-002	GL3602-003	GL3602-004
12in (30.5cm)	◆ GL3604-001	◆ GL3604-002	GL3604-003	GL3604-004
14in (35.6cm)	GL3606-001	GL3606-002	GL3606-003	GL3606-004
16in (40.6cm)	GL3608-001	GL3608-002	GL3608-003	GL3608-004

Offset Handle Overall Length	Straight Jaws	Slightly Curved Jaws	Curved Jaws	Angled Jaws
8-1/2in (21.6cm)	GL3600-005	GL3600-006	GL3600-007	GL3600-008
9-1/2in (24cm)	GL3602-005	GL3602-006	GL3602-007	GL3602-008
12in (30.5cm)	GL3604-005	GL3604-006	GL3604-007	GL3604-008
14in (35.6cm)	GL3606-005	GL3606-006	GL3606-007	GL3606-008

OB/GYN

Forceps/Clamps

Forceps/Clamps
Zangen/Klemmen
Pinze/Morse
Fórceps/Pinças
Fórceps/Pinças
鉗子/クランプ

RUSSELL Uterine Forceps

Longitudinal serrations, 1 x 2 teeth.

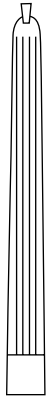

GL3240

Straight.
Overall length
8in (20.3cm).



GL3241

Straight.
Overall length
9-3/4in (24.7cm).

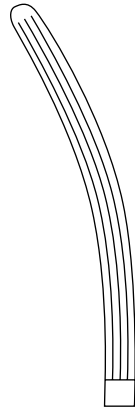

GL3250

Curved.
Overall length
8in (20.3cm).



PHANEUF Hysterectomy Forceps

Serrated. 1 x 2 teeth.



GL3180

Straight.
Overall length
8-1/4in (21cm).

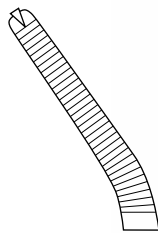

GL3181

Angled-on-flat.
Overall length
8-1/2in (21.6cm).

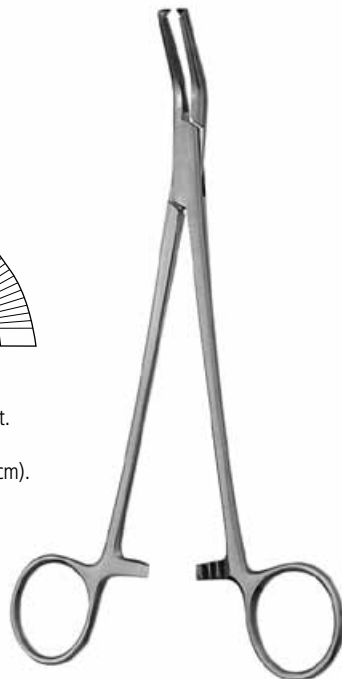

Instrument sizes, particularly overall lengths, are specified in this catalog as accurately as possible. Slight variations may occur due to metal crafting and finishing operations. Refer to the introductory pages for clarification on measurements. We reserve the right to modify products and/or services depicted herein without customer notice.

WERTHEIM Vaginal Forceps

Curved, serrated.

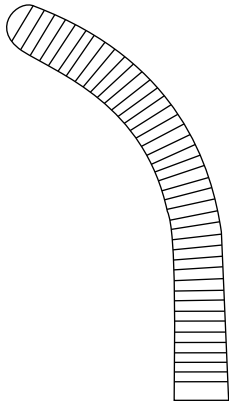

GL3320

Overall length
10in (25.4cm).



WERTHEIM-CULLEN Pedicle Forceps

Angled, longitudinal serrations.

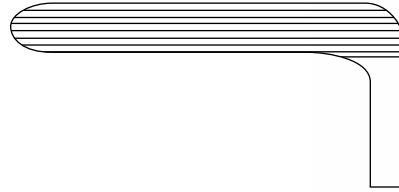

GL3350

Overall length
8-1/2in (21.6cm).

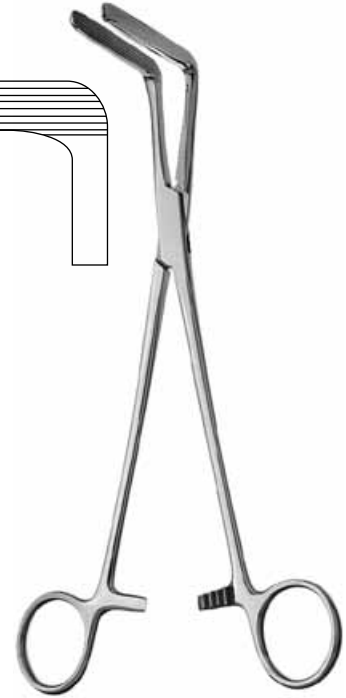

KELLY Placenta Forceps

Curved, serrated, fenestrated jaw.

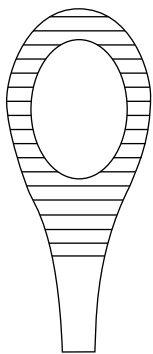

GL5800

Overall length
12-1/2in (32cm).



DE LEE Ovum Forceps

Straight, flat, fenestrated jaw. Mirror finish.



GL5820

Overall length
9-1/2in (24.1cm).



Forceps

Forceps
Zangen
Pinze
Fórceps
Fórceps
鉗子

HIRST-EMMETT Placenta Forceps

Curved, fenestrated jaw.



GL5830

Overall length
11in (27.9cm).



BARRETT Placenta Forceps

Fenestrated blade. Mirror finish.

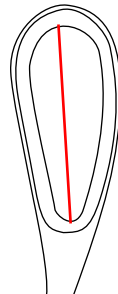

가 : 18 :24mm

GL5840

Overall length
10in (25.4cm).



BILROTH Tumor Forceps

Straight. 4 x 4 prongs.

GL1150

Overall length
11in (27.9cm).



DOYEN Tumor Screw

Mirror finish.

GL1210

Screw diameter
15/16in (2.4cm).
Overall length
6-7/8in (17.4cm).



Sondes/Dilatateurs
Sonden/Dilatatoren
Sonde/Dilatatori
Sondas/Dilatadores
Sondas/Dilatadores
プローブ/拡張器

EMMETT Uterine Probe

GL1300

Working length
8-1/2in (21.6cm).
Overall length
11-1/2in (29.2cm).



SIMS Uterine Sounds

Overall length 14-1/4in (36.2cm).

GL1310

Without graduations.

◆ **GL1320**
Graduated in centimeters.



SIMPSON Uterine Sound

GL1330

Graduated in inches.
Working length
9in (22.9cm).
Overall length
13-1/2in (34.3cm).



HEGAR Uterine Dilators

Solid, single-ended. Mirror finish.
Overall length 7-1/4in (18.5cm).

GL1401

Set of 26.
Single ended.
One of each size.

GL1401-001

Size 1mm.

GL1401-002

Size 2mm.

GL1401-003

Size 3mm.

GL1401-004

Size 4mm.

GL1401-005

Size 5mm.

GL1401-006

Size 6mm.

GL1401-007

Size 7mm.

GL1401-008

Size 8mm.

GL1401-009

Size 9mm.

GL1401-010

Size 10mm.

GL1401-011

Size 11mm.

GL1401-012

Size 12mm.

GL1401-013

Size 13mm.

GL1401-014

Size 14mm.

GL1401-015

Size 15mm.

GL1401-016

Size 16mm.

GL1401-017

Size 17mm.

GL1401-018

Size 18mm.

GL1401-019

Size 19mm.

GL1401-020

Size 20mm.

GL1401-021

Size 21mm.

GL1401-022

Size 22mm.

GL1401-023

Size 23mm.

GL1401-024

Size 24mm.

GL1401-025

Size 25mm.

GL1401-026

Size 26mm.

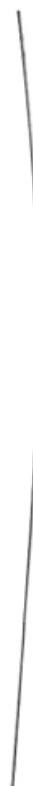

HEGAR Uterine Dilators

Hollow, double-ended. Mirror finish.
Overall length 8in (20.3cm).

◆ **GL1411**

Set of eight. One of each size.

GL1411-001

Size 3-4mm.

GL1411-002

Size 5-6mm.

GL1411-003

Size 7-8mm.

GL1411-004

Size 9-10mm.

GL1411-005

Size 11-12mm.

GL1411-006

Size 13-14mm.

GL1411-007

Size 15-16mm.

GL1411-008

Size 17-18mm.



Dilators/Curettes

Dilatateurs/Curettes
 Dilatatoren/Küretten
 Dilatori/Curette
 Dilatadores/Curetas
 Dilatadores/Curetas
 拡張器/キュレット

PRATT Uterine Dilators

Solid, double-ended. Mirror finish. Overall length 11-3/8in (28.9cm).

◆ GL1451

Each dilator in two sizes, French scale as follows:
 13-15, 17-19, 21-23, 25-27, 29-31, 33-35, 37-39, 41-43.
 Set of eight.

GL1450-001

Size 13-15Fr.

GL1450-002

Size 17-19Fr.

GL1450-003

Size 21-23Fr.

GL1450-004

Size 25-27Fr.

GL1450-005

Size 29-31Fr.

GL1450-006

Size 33-35Fr.

GL1450-007

Size 37-39Fr.

GL1450-008

Size 41-43Fr.



HANK Uterine Dilators

Double-ended. Mirror finish. Overall length 10-1/2in (26.7cm).

◆ GL1460

American. Solid. Each dilator in two sizes, scale as follows:
 9-10, 11-12, 13-14, 15-16,
 17-18, 19-20. Set of six.

GL1461-001

Size 9-10.

GL1461-002

Size 11-12.

GL1461-003

Size 13-14.

GL1461-004

Size 15-16.

GL1461-005

Size 17-18.

GL1461-006

Size 19-20.



HANK-BRADLEY Uterine Dilators

Cannulated. Double-ended. Mirror finish. Overall length 10-1/2in (26.7cm).

GL1471-001

Size 9-10.

GL1471-002

Size 11-12.

GL1471-003

Size 13-14.

GL1471-004

Size 15-16.

GL1471-005

Size 17-18.

GL1471-006

Size 19-20.



SIMS Uterine Curettes

Sharp. Malleable. Mirror and Satin finish. Overall length 11in (27.9cm).



GL1600-00
Size 00.



GL1600-0
Size 0.



GL1600-001
Size 1.



◆ GL1600-002
Size 2.



GL1600-003
Size 3.



GL1600-004
Size 4.



GL1600-005
Size 5.



GL1600-006
Size 6.



THOMAS Uterine Curettes

Blunt. Malleable. Overall length 11in (27.9cm).



GL1610-001

Size 1.



GL1610-003

Size 3.

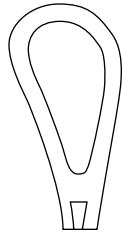

GL1610-005

Size 5.

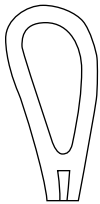

GL1610-002

Size 2.



GL1610-004

Size 4.



GL1610-006

Size 6.



BALLENTINE Uterine Curette

GL1620

Double-ended, size 2-4, malleable. Overall length 13-5/8in (34.6cm).



HUNTER Large Uterine Curette

Mirror and Satin finish.

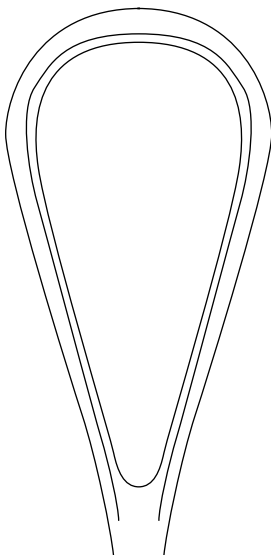

◆ **GL1625**

Blade 3cm wide.
Working length 8in (20.3cm).



RECAMIER Uterine Curettes

Sharp. Overall length 11in (27.9cm).



GL1630-001

Size 1.



GL1630-003

Size 3.

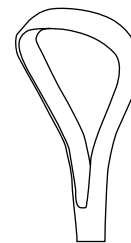

GL1630-005

Size 5.



GL1630-002

Size 2.



GL1630-004

Size 4.

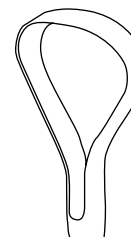

GL1630-006

Size 6.



Curettes

Curettes
Küretten
Curette
Curetas
Curetas
キュレット

HEANEY Uterine Curette

Serrated cutting edge, malleable.
Mirror and Satin finish.



GL1700

Overall length
9-5/8in (24.4cm).



KELLY-GRAY Uterine Curettes

Serrated cutting edge.
Overall length 9-1/2in (24.1cm).



GL1701

Size 1.



GL1703

Size 3.



GL1702

Size 2.



GL1704

Size 4.



RANDALL Endometrial Biopsy Suction Curettes

Luer lock hub.

GL1740

Outside diameter 4mm.
Overall length
9-1/4in (23.5cm).



NOVAK Endometrial Biopsy Suction Curette

Curved, with Luer lock hub.

GL1750

Overall length
9-1/4in (23.5cm).



KEVORKIAN-YOUNGE Endocervical Biopsy Curette

Slightly curved.



◆ **GL1775**

Overall length
12in (30.5cm).



GARCIA Endometrial Biopsy Curette

Mirror and Satin finish.

GL1796

Window 2.3mm x 3.5mm.
Working length
7-3/4in (19.7cm).



LAUFE Uterine Polyp Forcep

Curved, serrated jaws. Overall length 8in (20.3cm).

GL1820



OVERSTREET Endometrial Polyp Forceps

Hollow, fenestrated jaw.



GL1800-1

Overall length 9-1/4in (23.5cm).



FLETCHER-VAN DOREN Uterine Polyp, Sponge Holding Forceps

Double-curved.

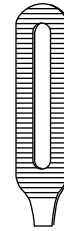

◆ **GL1805**

Overall length 9-1/2in (24.1cm).



GAYLOR Uterine Specimen Forceps

Angled, sharp, cup-shaped jaws.



GL1902

Overall length 9in (22.9cm).



THOMS-GAYLOR Uterine Biopsy Punch

Angled, sharp, cup-shaped jaws.

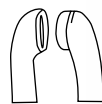

GL1900

Overall length 9in (22.9cm).

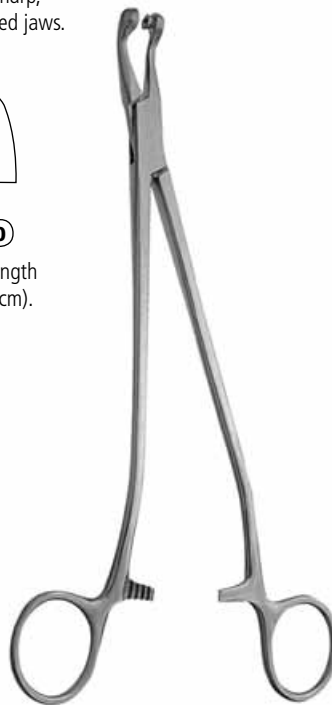

SCHUBERT Uterine Biopsy Punch Forceps

Overall length 8-1/2in (21.6cm).



GL1910

Straight.

GL1920

Curved-on-side.



Forceps

Forceps
Zangen
Pinze
Fórcps
Fórcps
鉗子

KEVORKIAN-YOUNGE Biopsy Forceps

Narrow jaws. Fine teeth in lower jaw; serrations on sides. Jaws open to almost 90°, with sharp cutting edges.



◆ **GL1925**

Cup size 8.5mm x 3.5mm wide.
Overall length 10in (25.4cm).

EPPENDORFER Cervical Biopsy Forceps



GL1926

3.5mm x 8mm cup.
Working length 8-1/2in (21.6cm).

TISCHLER Cervical Biopsy Punch Forceps

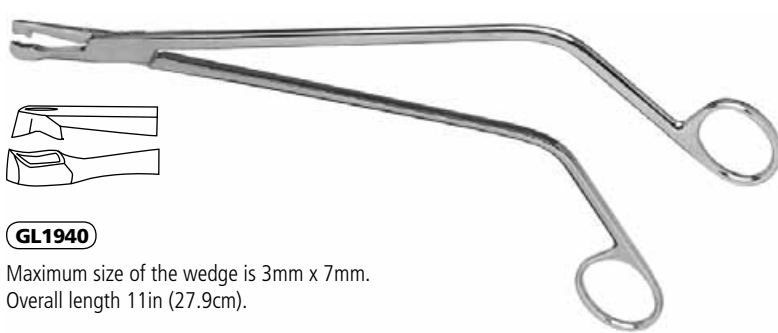

GL1940

Maximum size of the wedge is 3mm x 7mm.
Overall length 11in (27.9cm).

TISCHLER Cervical Biopsy Punch Forceps

Alligator-type.



◆ **GL1942**

Working length
9in (22.9cm).

◆ **GL1943**

Oblong specimen size
(5mm x 2.5mm x 1.5mm
maximum thickness). Working
length 8-3/4in (22.2cm).

VAN DOREN Uterine Biopsy Punch Forceps

Angled.



GL1930

Overall length
10in (25.4cm).

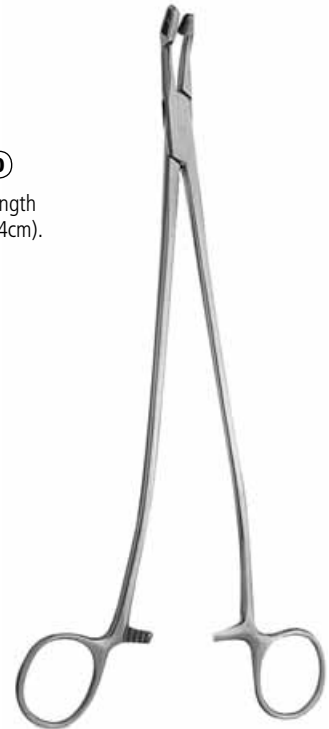

Forceps/Canules
Zangen/Kanülen
Pinze/Cannulas
Fórceps/Cânulas
Fórceps/Cânulas
鉗子/カニューレ

TISCHLER Cervical Biopsy Punch Forceps

Rotatable shaft. Working length 9in (22.9cm). Overall length 12in (30.5cm).



GL1945

3mm x 7mm bite.

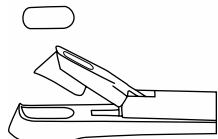

◆ **GL1946**

2mm x 4mm bite.

FLEMING Conization Instrument

Adjustable blade, from straight to 7mm arc. Cuts left or right. Matte and Mirror finish.



GL1965

Overall length 10in (25.4cm).

GL1966

Replacement Conization Blades for GL1965. Single use, non-sterile. Six per package.



KAHN Uterine Trigger Cannula

Mirror and Satin finish.

◆ **GL2360**

Includes two flexible extension tips, standard and giant-size acorn tips, acorn stop-collar. Overall length 12-5/8in (32cm).

GL2360-001

KAHN Silicone Rubber Acorn Tip only. Giant size. Overall length 1-1/2in (3.8cm).

GL2360-002

Flexible Extension Tip only.



JARCHO Self-Retaining Uterine Cannula

GL2375

Cannula. Overall length 8-1/4in (21cm).

GL2375-001

Tenaculum Holder for GL2375. Overall length 2-1/4in (5.7cm).



NEAL Fallopian Cannula

Useful in fallopian tube patency testing. Mirror finish. Stainless steel body.

GL2400

Overall length 11-1/2in (29.2cm).



Silicone Rubber Acorn

Attaches to syringe or irrigator for bladder and urethral irrigations.

GU4360

Standard size. Overall length 1-1/16in (2.7cm).



Needles/Forceps

Aiguilles/Forceps
Nadeln/Zangen
Aghi/Pinze
Agujas/Fórceps
Aguilhas/Fórceps
針/鉗子

COLLYER Pelvimeter

GL5000

Graduated in inches and centimeters. External measurements.



V. Mueller® Paracervical and Pudendal Nerve Block Needle

A stud pin on the needle, just ahead of its Luer lock hub, fits in a slot in the proximal end of the protective sheath to hold the needle safely retracted until it is on target,

GL5150

Overall length retracted 8in (20.3cm).

GL5151

Replacement Needle only for GL5150. Mirror and Satin finish.



IOWA-Type Trumpet Needle Guide Block.

Mirror finish.

GL5155

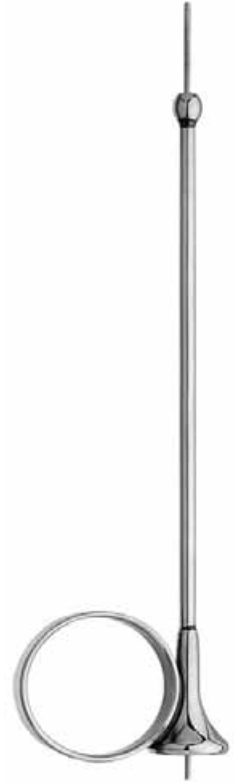

IOWA Membrane Puncturing Forceps



GL5260

Overall length 10in (25.4cm).

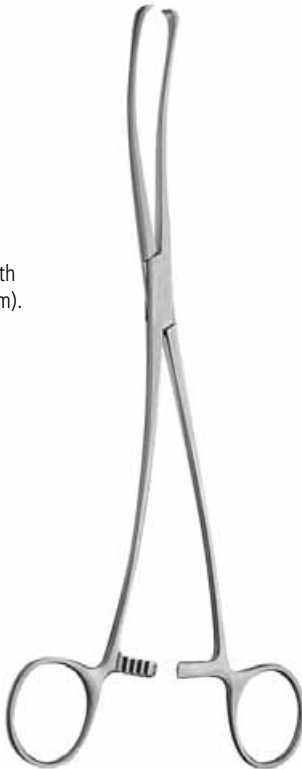

SIMPSON Obstetrical Forceps

Mirror and Satin finish.

GL5300

Overall length 14in (36cm).

GL5301

Overall length 12in (30.5cm).



DE LEE Obstetrical Forceps

Mirror and Satin finish.

GL5320-4

Overall length 12in (30.5cm).



KIELLAND Obstetrical Forceps

Mirror finish.

GL5510-1

Overall length
16in (40.6cm).



LUIKART-KIELLAND Obstetrical Forceps

Solid LUIKART blades.
Mirror finish.

GL5520

Overall length
16-1/2in (41.9cm).



McLANE-TUCKER Obstetrical Forceps

Overall length
16-1/4in (41.3cm).

GL5525

Solid LUIKART blades.



PIPER Obstetrical Forceps

Mirror and Satin finish.

GL5500

Overall length
18in (46.0cm).



BILL Traction Handle

GL5600

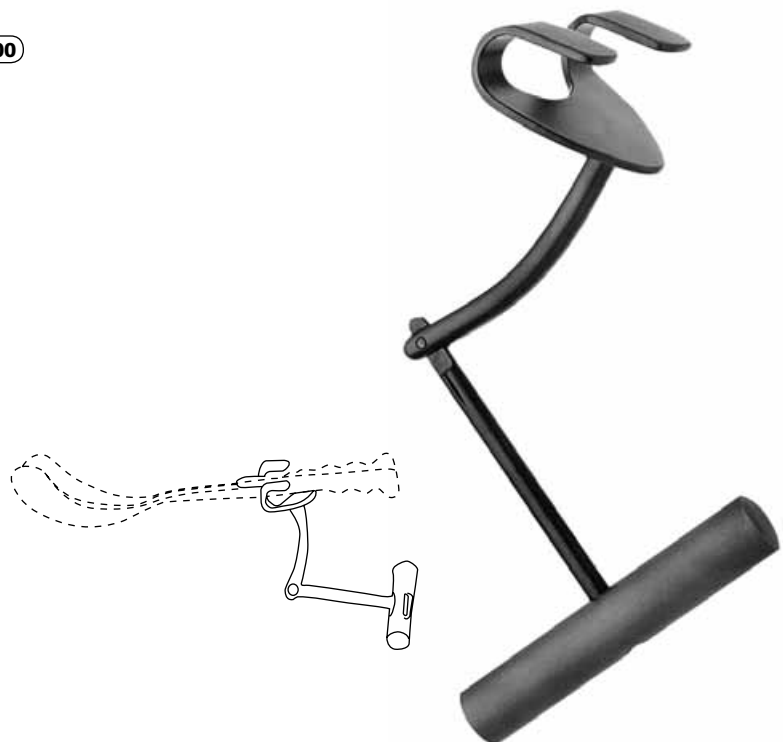

Forceps/Scissors

Forceps/Ciseaux
Zangen/Scheren
Pinze/Forbici
Fórceps/Tijeras
Fórceps/Tesoura
鉗子/鉗

MOGEN Circumcision Clamp

◆ **GL7021**



Fallopian Tube Forceps

GL4012

Small. Overall length
8-1/8in (20.6cm).



Retracting Rods

Teflon® tip.

GL4110-001

Size 1mm. Overall length
7-5/8in (19.4cm).

GL4110-002

Size 3.5mm. Overall length
7-3/4in (19.7cm).

GL4110-003

Size 5mm. Overall length
7-3/4in (19.7cm).



Tubal Scissors

Straight. Round handle.

GL4318

Overall length
7in (18cm).



Micro-Tubal Scissors

Matte and Mirror finish.
Overall length 7in (17.8cm).



GL4321

Curved.

GL4322

Curved,
serrated tips.



GL4323

Straight.



Écarteurs/Crochets/Divers
 Wundspreizer/Retraktoren/Haken/Verschiedenes
 Divaricatori/Uncini/Varie
 Separadores/Ganchos/Varios
 Retratores/Ganchos/Diversos
 リトラクター/フック/その他

LATERAL Vaginal Retractor

Blades fit inside a vaginal speculum. Ratchet handle.

GL495

Overall length
 11in (28cm).

**EMMETT Hooks Quick Release**

Overall length 9in (22.9cm).

**GL805**

No. 1.

**GL806**

No. 2.



OB/GYN

Inflated Rubber Pessaries

No Latex.

GL2670-001

Size 2-1/4in (5.7cm).

GL2670-002

Size 2-1/2in (6.4cm).

GL2670-003

Size 2-3/4in (7cm).

GL2670-004

Size 3in (7.6cm).

GL2670-005

Size 3-1/4in (8.3cm).

**BETHEA Sheet Holders**

These are a convenient and comfortable means of holding sheets and drapes during examination and treatment. Mirror finish.

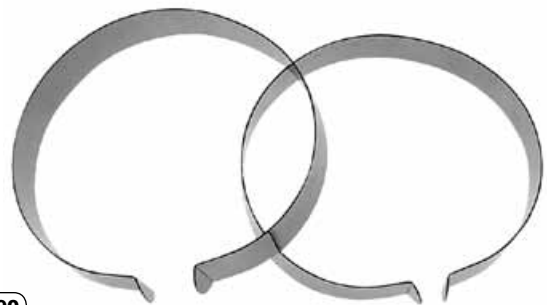
**GL5190**

Pair.

