

# General and Micro Surgical Instruments

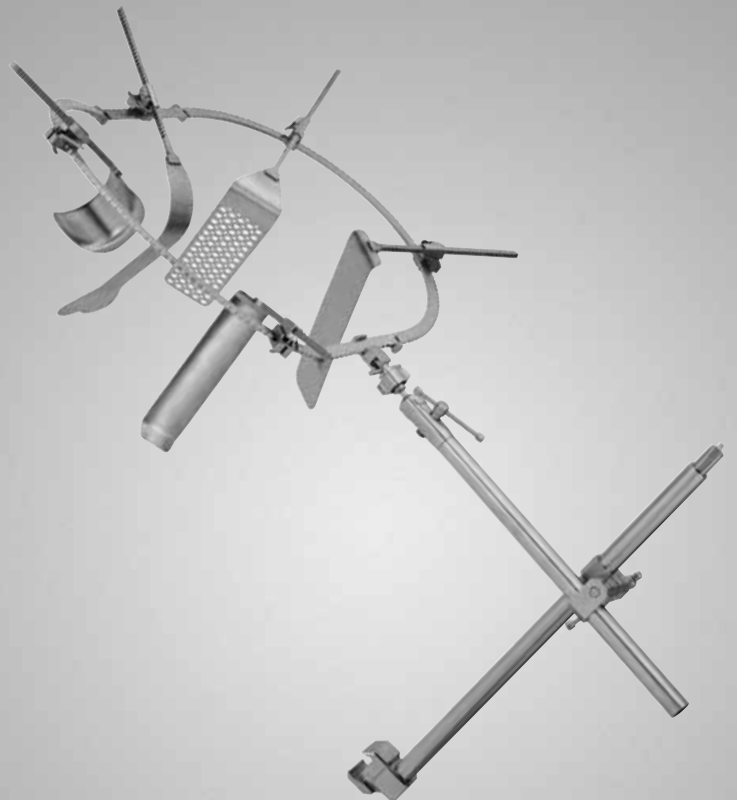
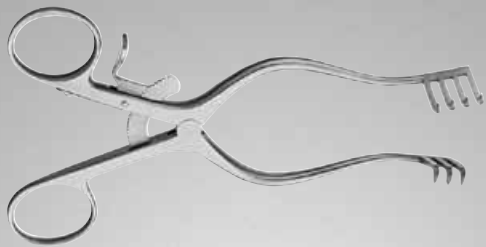

## Knife Handles

Manches de couteau  
Messergriffe  
Impugnatura di bisturi  
Mangos de cuchillos  
Cabos de facas  
ナイフハンドル

### No. 3 Knife Handle

For blades nos. 10, 11, 12 and 15.  
wMirror finish.

◆ **SU1403-001**

Overall length  
5in (12.7cm).



### No. 3L Knife Handle

For blades nos. 10, 11,  
12 and 15. Long.  
Mirror finish.

◆ **SU1403-002**

Overall length  
8-3/8in (21.3cm).

### SU1403-012

Overall length  
12in (30.5cm).

### SU1403-014

Overall length  
14in (35.5cm).



### No. 3LA Knife Handle

For blades nos. 10, 11,  
12 and 15. Long, angled.  
Mirror finish.

◆ **SU1403-003**

Overall length  
8in (20.3cm).



### No. 4 Knife Handle

For blades nos. 20, 21,  
22, 23, 24 and 25.  
Mirror finish.

◆ **SU1404-001**

Overall length  
5-3/8in (13.7cm).



### No. 4L Knife Handle

For blades nos. 20, 21,  
22, 23, 24 and 25. Long.  
Mirror finish.

◆ **SU1404-002**

Overall length  
8-3/8in (21.3cm).



### No. 7 Knife Handle

For blades nos. 10, 11,  
12 and 15.  
Mirror finish.

◆ **SU1407**

Overall length  
6-3/8in (16.2cm).



Manches de couteau  
 Messergriffe  
 Impugnatura di bisturi  
 Mangos de cuchillos  
 Cabos de facas  
 ナイフハンドル

**No. 9 Knife Handle**

Delicate.  
 For blades nos.  
 10, 11, 12 and 15.  
 Mirror finish.

**SU1409**

Overall length  
 4-3/4in (12cm).



**No. 5S Knife Handle**

Round, knurled.  
 Self-locking.

**OP0701**

Overall length  
 4in (10.2cm).



**No. 3H Knife Handles**

Hexagonal.

◆ **OP0702**

Overall length  
 4in (10.2cm).

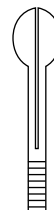

**OP0702-001**

Collet only for  
 No. 3H knife handle.



**No. 3HL Knife Handle**

Hexagonal.

◆ **OP0703**

Overall length  
 6in (15.2cm).



**No. 3K Knife Handle**

Round, knurled.

◆ **OP0705**

Overall length  
 4in (10.2cm).



**No. 5 Knife Handle**

Round, knurled.

**SU01571**

Overall length  
 5-1/4in (13.3cm).



## Knife Handles

Manches de couteau  
Messergriffe  
Impugnatura di bisturi  
Mangos de cuchillos  
Cabos de facas  
ナイフハンドル

### No. 3KM Blade Handle

Round, knurled.

**OP1312**

Overall length  
3in (7.6cm).



### No. 3KL Blade Handle

Round, knurled.

**OP1320**

Overall length  
6in (15.2cm).



### No. 3KD Blade Handle

Round, knurled.

**OS01350**

Overall length  
5-1/4in (13.3cm).



### No. 6D Blade Handle

Round, knurled.

**OS01360**

Overall length  
5-1/4in (13.3cm).



### No. 7A Blade Handle

Round, knurled.

**OS01394**

Overall length  
7-1/2in (19cm).



### No. 6 Blade Handle

**OS0306**

Overall length  
5-1/4in (13.3cm).



### No. 6P Blade Handle

**OS01410**

Overall length  
4-1/4in (10.8cm).



**Micro-Line® Operating Scissors**

Delicate. Sharp/Blunt.  
Mirror finish.  
Overall length  
5in (12.7cm).

**SU1698**

Straight.

**SU1728**

Curved-on-flat.

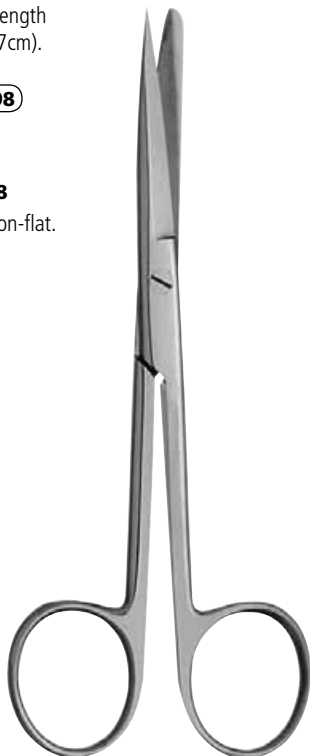

**Operating Scissors**

Straight.  
Sharp/Blunt.  
Mirror finish.

**SU1700**

Overall length  
4-3/4in (12.1cm).

**SU1701**

Overall length  
5in (12.7cm).

◆ **SU1702**

Overall length  
5-3/4in (14.6cm).

**SU1703**

Overall length  
6in (15.2cm).

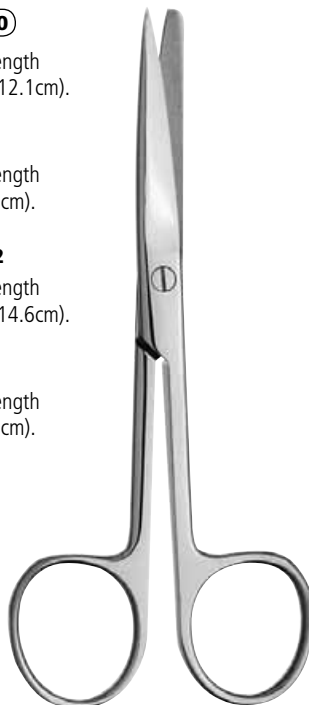

**Operating Scissors**

Straight.  
Sharp/Sharp.  
Mirror finish.

**SU1710**

Overall length  
4-3/4in (12.1cm).

**SU1711**

Overall length  
5in (12.7cm).

**SU1712**

Overall length  
5-3/4in (14.6cm).

**SU1713**

Overall length  
6in (15.2cm).

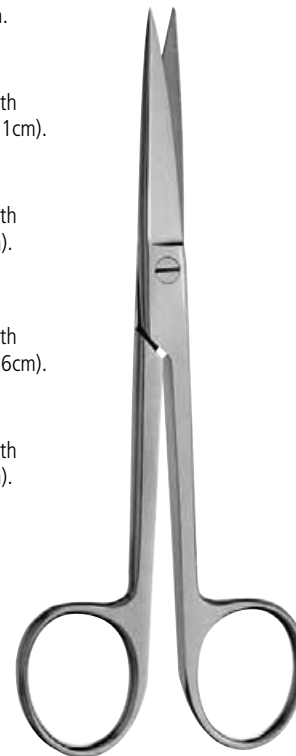

**Operating Scissors**

Straight.  
Blunt/Blunt.  
Mirror finish.

**SU1720**

Overall length  
4-3/4in (12.1cm).

**SU1721**

Overall length  
5in (12.7cm).

**SU1722**

Overall length  
5-3/4in (14.6cm).

**SU1723**

Overall length  
6in (15.2cm).



**Operating Scissors**

Curved-on-flat.  
Sharp/Blunt.  
Mirror finish.

**SU1730**

Overall length  
4-3/4in (12.1cm).

**SU1731**

Overall length  
5in (12.7cm).

**SU1732**

Overall length  
5-3/4in (14.6cm).

**SU1733**

Overall length  
6in (15.2cm).

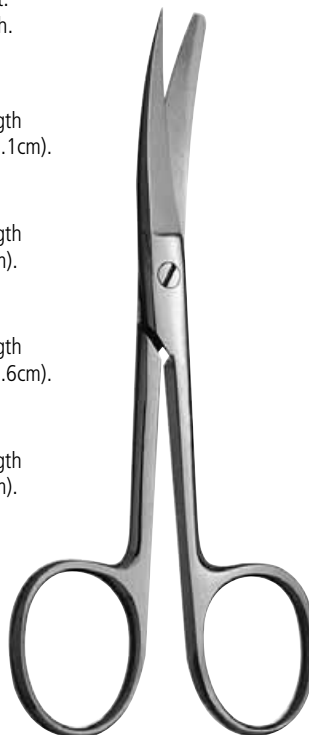

**Vital® Operating Scissors**

Sharp/Blunt. Stellite®  
cutting edges.  
Overall length  
5-3/4in (14.6cm).

**SU1755**

Straight.

**SU1756**

Curved.



## Scissors

Ciseaux  
Scheren  
Forbici  
Tijeras  
Tesoura  
鉋

### Operating Scissors

Curved-on-flat.  
Sharp/Sharp.  
Mirror finish.

#### SU1740

Overall length  
4-3/4in (12.1cm).

#### SU1741

Overall length  
5in (12.7cm).

#### SU1742

Overall length  
5-3/4in (14.6cm).

#### SU1743

Overall length  
6in (15.2cm).



### Vital® Operating Scissors

Sharp/Sharp. *Stellite®*  
cutting edges.  
Overall length  
5-3/4in (14.6cm).

#### SU1757

Straight.

#### SU1758

Curved.



### Operating Scissors

Curved-on-flat.  
Blunt/Blunt.  
Mirror finish.

#### SU1750

Overall length  
4-3/4in (12.1cm).

#### SU1751

Overall length  
5in (12.7cm).

#### SU1752

Overall length  
5-3/4in (14.6cm).

#### SU1753

Overall length  
6in (15.2cm).

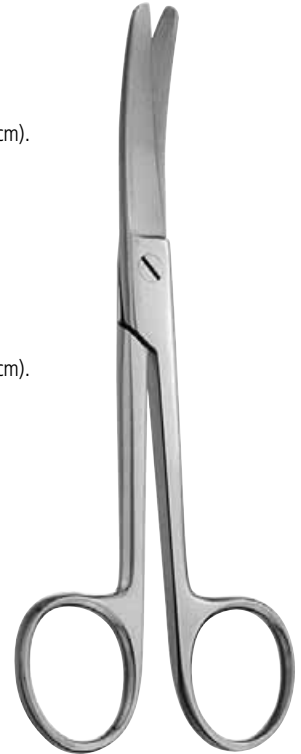

### Vital® Operating Scissors

Blunt/Blunt. *Stellite®*  
cutting edges.  
Overall length  
5-1/2in (14cm).

#### SU1759

Straight.

#### SU1760

Curved.



### DEAVER Operating Scissors

Sharp/Blunt.  
Mirror finish.  
Overall length  
5-1/2in (14cm).

#### SU1765

Straight.

#### SU1766

Curved.



### MAYO Operating Scissors

Straight.  
Sharp/Sharp.  
Mirror finish.

#### SU1780

Overall length  
5in (12.7cm).

#### SU1781

Overall length  
5-1/2in (14cm).



**MAYO Operating Scissors**

Curved.  
Sharp/Sharp.  
Mirror finish.

**SU1785**

Overall length  
5in (12.7cm).

**SU1786**

Overall length  
5-1/2in (14cm).



**MAYO Micro-Line® Dissecting Scissors**

Overall length  
5-1/2in (14cm).

**SU1798**

Delicate.  
Straight.  
Blunt/Blunt.  
Mirror finish.

**SU1808**

Curved-on-flat.  
Blunt/Blunt.  
Mirror finish.



**MAYO-NOBLE Dissecting Scissors**

Heavy.

**SU1860**

Straight.  
Overall length  
6-3/4in (17.1cm).

**SU1862**

Curved-on-flat.  
Overall length  
6-1/2in (16.5cm).

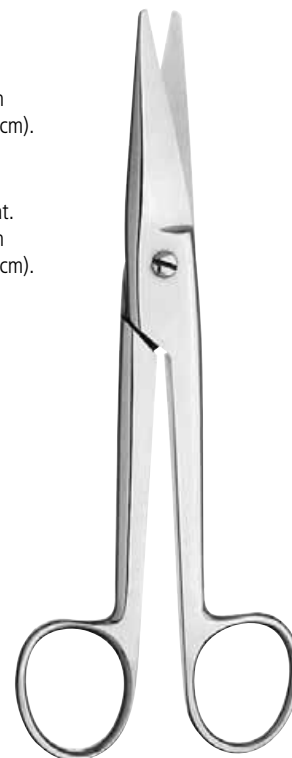

**MAYO Dissecting Scissors**

Mirror finish.

**SU1800**

Straight.  
Overall length  
5-3/4in (14.6cm).

◆ **SU1801**

Straight.  
Overall length  
6-3/4in (17.1cm).

**SU1801-001**

Straight, left-handed.  
Overall length  
6-3/4in (17.1cm).

**SU1810**

Curved-on-flat.  
Overall length  
5-3/4in (14.6cm).

◆ **SU1811**

Curved-on-flat.  
Overall length  
6-3/4in (17.1cm).

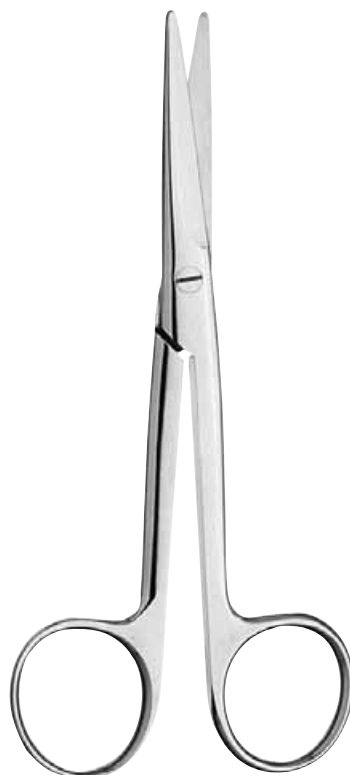

**Vital® MAYO Dissecting Scissors**

Beveled blades. Stellite® cutting edges.

◆ **SU1803**

Straight.  
Overall length  
5-1/2in (13.9cm).

**SU1813**

Curved.  
Overall length  
5-1/2in (13.9cm).

◆ **SU1804**

Straight.  
Overall length  
6-3/4in (17.1cm).

◆ **SU1814**

Curved.  
Overall length  
6-3/4in (17.1cm).

**CH2086**

Straight.  
Overall length  
9in (22.9cm).

◆ **CH2096**

Curved.  
Overall length  
9in (22.9cm).

**CH2088**

Straight.  
Overall length  
14in (35.6cm).

**CH2098**

Curved.  
Overall length  
14in (35.6cm).



## Scissors

Ciseaux  
Scheren  
Forbici  
Tijeras  
Tesoura  
鋏

### Super Cut MAYO Dissecting Scissors

Mirror finish.

#### **SU1800-S**

Straight. Overall length  
5-1/2in (14cm).

#### ◆ **SU1801-S**

Straight. Overall length  
6-3/4in (17.1cm).

#### **SU1810-S**

Curved. Overall length  
5-1/2in (14cm).

#### ◆ **SU1811-S**

Curved. Overall length  
6-3/4in (17.1cm).

#### **CH2086-S**

Straight. Overall length  
9in (22.9cm).

#### **CH2096-S**

Curved. Overall length  
9in (22.9cm).



### MAYO Dissecting Scissors

Round blade.

#### **SU1820**

Straight. Overall length  
5-3/4in (14.6cm).

#### ◆ **SU1821**

Straight. Overall length  
6-3/4in (17.1cm).

#### **SU1825**

Curved-on-flat. Overall length  
5-3/4in (14.6cm).

#### **SU1826**

Curved-on-flat. Overall length  
6-3/4in (17.1cm).



### Vital® MAYO Dissecting Scissors

Round blades.  
Stellite® cutting edges.

#### **SU1803-002**

Straight.  
Overall length  
5-1/2in (14cm).

#### ◆ **SU1804-002**

Straight.  
Overall length  
6-3/4in (17.1cm).

#### **SU1813-002**

Curved.  
Overall length  
5-1/2in (14cm).

#### ◆ **SU1814-002**

Curved.  
Overall length  
6-3/4in (17.1cm).



### MAYO-SIMS Dissecting Scissors

Blunt/Blunt.  
Mirror finish.  
Overall length  
7-3/4in (19.7cm).

#### **SU1816**

Straight.

#### **SU1817**

Curved-on-flat.

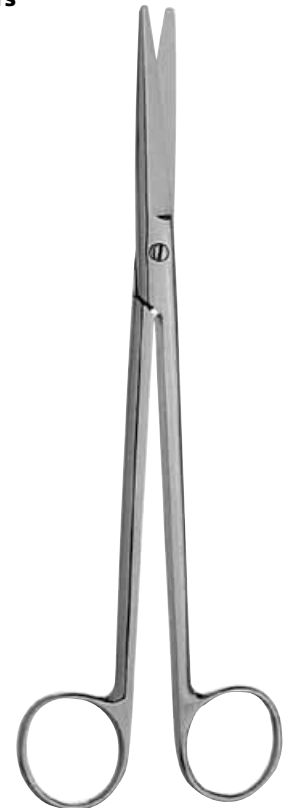



**MAYO Dissecting Scissors**

Round blade.

**SU1935**

Curved-on-flat. Extra-long, heavy blades. One large ring. Overall length 14in (35.6cm).



**MAYO-HARRINGTON Dissecting Scissors**

Mirror finish.

**CH2085**

Straight. Overall length 9in (22.9cm).

**CH2080**

Straight. Overall length 11in (27.9cm).

◆ **CH2095**

Curved. Overall length 9in (22.9cm).

**CH2090**

Curved. Overall length 11in (27.9cm).

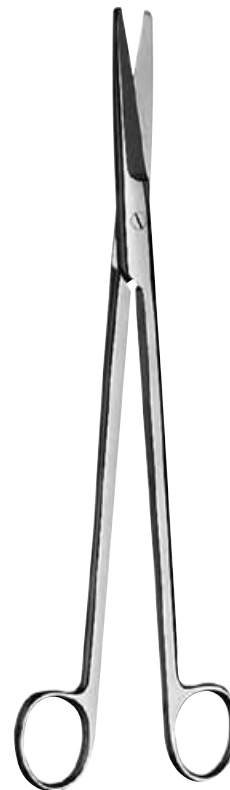

**Super Cut MAYO-HARRINGTON Scissors**

Curved.

One serrated blade. Mirror and Satin finish.

**CH2075-S**

Overall length 12in (30.5cm).



**JONES Dissecting Scissors**

Curved blades, delicate.

Mirror finish.

**SU1922**

Overall length 5-1/2in (14cm).



**Scissors**

Ciseaux  
Scheren  
Forbici  
Tijeras  
Tesoura  
鉋

**METZENBAUM-LIPSETT Scissors**

Curved. Serrated edges.  
METZENBAUM blades  
thinned down 7/8in  
(2.2cm) from tips.  
Blades 3.5cm from  
mid-screw.  
Mirror finish.

**RH1652**

Overall length  
5-1/2in (14cm).

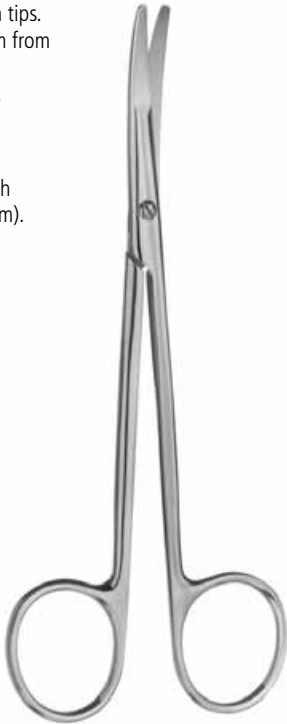

**METZENBAUM Dissecting Scissors**

Delicate.  
Curved-on-flat.  
Mirror finish.

◆ **SU1945**

Overall length  
7in (17.8cm).

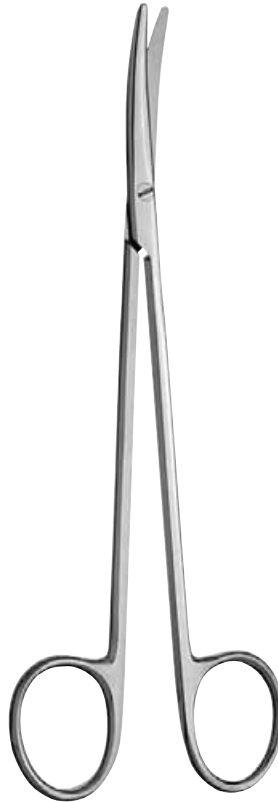

**METZENBAUM Dissecting Scissors**

Light model. Fine,  
narrow blades are  
curved for delicate  
dissections. Mirror finish.

◆ **MO1603**

Overall length  
7-3/8in (18.7cm).



**METZENBAUM Dissecting Scissors**

Blunt/Blunt.  
Mirror and Satin finish.

**RH1640**

Straight.  
Overall length  
5-3/4in (14.6cm).

◆ **RH1650**

Curved.  
Overall length  
5-3/4in (14.6cm).

**RH1650-001**

Curved.  
Overall length  
5-3/4in (14.6cm).  
Left-handed.

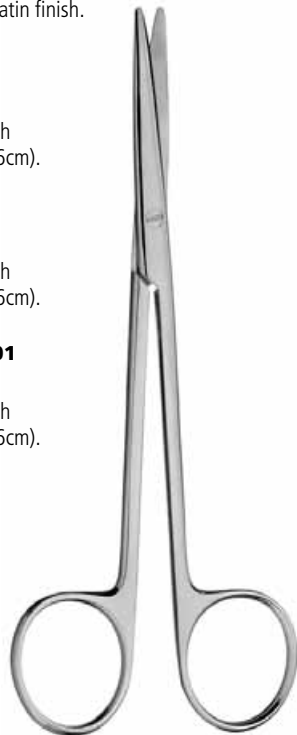

**METZENBAUM Dissecting Scissors**

Dissecting blades.  
Blunt/Blunt.  
Overall length  
7in (17.8cm).

**MO1598**

Straight.

◆ **MO1600**

Slightly  
curved-on-flat.

**MO1600-001**

Slightly  
curved-on-flat.  
Left-handed.



**Vital® METZENBAUM Dissecting Scissors**

Blunt/Blunt.  
Stellite® cutting edges.

◆ **RH1653**

Straight.  
Overall length  
5-3/4in (14.6cm).

◆ **RH1651**

Curved.  
Overall length  
5-3/4in (14.6cm).



**Vital® METZENBAUM Dissecting Scissors**

Blunt/Blunt. **Stellite®** cutting edges.  
Overall length  
7in (17.8cm).

**MO1602**

Straight.

◆ **MO1601**

Curved.

**Vital® METZENBAUM Dissecting Scissors**

Delicate. Blunt/Blunt.  
**Stellite®** cutting edges.

**RH1653-001**

Delicate. Straight.  
Overall length  
5-3/4in (14.6cm).

◆ **RH1651-001**

Delicate. Curved.  
Overall length  
5-3/4" (14.6cm).

**MO1602-001**

Straight.  
Overall length  
7in (17.8cm).

◆ **MO1601-001**

Curved.  
Overall length  
7in (17.8cm).

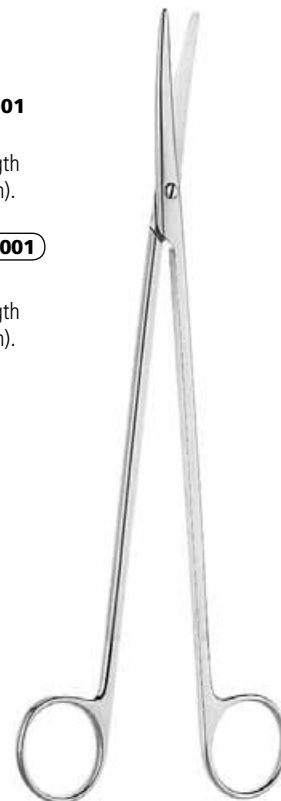
**CH2007-001**

Straight.  
Overall length  
9in (22.9cm).

◆ **CH2006-001**

Curved.  
Overall length  
9in (22.9cm).

**Vital® METZENBAUM Dissecting Scissors**

Delicate. Sharp/Sharp. **Stellite®** cutting edges.

**RH1653-002**

Straight. Overall length  
5-3/4in (14.6cm).

**RH1651-002**

Curved. Overall length  
5-3/4in (14.6cm).

**MO1602-002**

Straight. Overall length  
7in (17.8cm).

**MO1601-002**

Curved. Overall length  
7in (17.8cm).

**CH2007-002**

Straight. Overall length  
9-1/4in (23.5cm).

◆ **CH2006-002**

Curved. Overall length  
9-1/4in (23.5cm).

**Super Cut METZENBAUM Dissecting Scissors**

Curved. Mirror finish.

◆ **RH1650-S**

Overall length  
5-3/4in (14.6cm).



**Scissors**

Ciseaux  
Scheren  
Forbici  
Tijeras  
Tesoura  
鋏

**Super Cut METZENBAUM  
Dissecting Scissors**

Curved. Mirror finish.

◆ **MO1600-S**

Overall length  
7in (17.8cm).

**MO1604-S**

Overall length  
7in (17.8cm).



**METZENBAUM Dissecting Scissors**

Blunt/Blunt. Mirror and Satin finish.

◆ **CH2034-001**

Straight. Overall length  
8in (20.3cm).

**CH2034**

Curved. Overall length  
8in (20.3cm).

◆ **CH2032**

Curved. Overall length  
9in (22.9cm).

◆ **CH2030**

Curved. Overall length  
11-3/16in (28.4cm).



**Vital® METZENBAUM Dissecting  
Scissors**

Blunt/Blunt. Stellite®  
cutting edges.

◆ **CH2007**

Straight.  
Overall length  
9-1/4in (23.5cm).

◆ **CH2006**

Curved.  
Overall length  
9-1/4in (23.5cm).

**CH2008**

Curved.  
Overall length  
12in (30.5cm).

**CH2009**

Curved.  
Overall length  
14-1/2in (36.8cm).



**Super Cut METZENBAUM  
Dissecting Scissors**

Curved. Mirror finish.

◆ **CH2032-S**

Overall length  
9in (22.9cm).



**NELSON Lung Dissecting Scissors**

Blunt/Blunt.  
Mirror and Satin finish.  
Overall length  
9in (22.9cm).

◆ **CH2010**

Curved.

**CH2015**

Straight.



**Vital® NELSON Dissecting Scissors**

Curved. Blunt/Blunt.  
Stellite® cutting edges.  
Overall length  
11in (27.9cm).

**CH2020**

Regular.

**CH2020-001**

Delicate.



**Super Cut NELSON-METZ Dissecting Scissors**

Curved. One serrated blade.  
Mirror and Satin finish.

**CH2025-S**

Overall length  
11-3/4in (29.8cm).



**SISTRUNK Dissecting Scissors**

Slightly curved, serrated blades.  
Mirror finish.

**SU1872**

Overall length  
5-1/4in (13.3cm).



**DOYEN Dissecting Scissors**

Blunt/Blunt.  
Mirror finish.  
Overall length  
7in (17.8cm).

**SU1900**

Straight.

**SU1902**

Curved.



**LINCOLN Dissecting Scissors**

Blade length 30mm.

**SU1890**

Straight.  
Overall length  
7in (17.8cm).

**SU1895**

Curved.  
Overall length  
7in (17.8cm).

**SU1897**

Curved.  
Overall length  
11in (27.9cm).



**PANZER Gall Bladder Scissors**

Curved-on-flat, shanks angle to side of handles.  
Mirror finish.

**SU1930**

Overall length  
7in (17.8cm).



**Scissors**

Ciseaux  
Scheren  
Forbici  
Tijeras  
Tesoura  
鉋

**THOREK-FELDMAN Gall Bladder Scissors**

Curved-on-flat.

**SU1920**

Mirror finish.  
Overall length  
7-1/4in (18.4cm).

**SU1919**

Overall length  
8-1/2in (21.6cm).

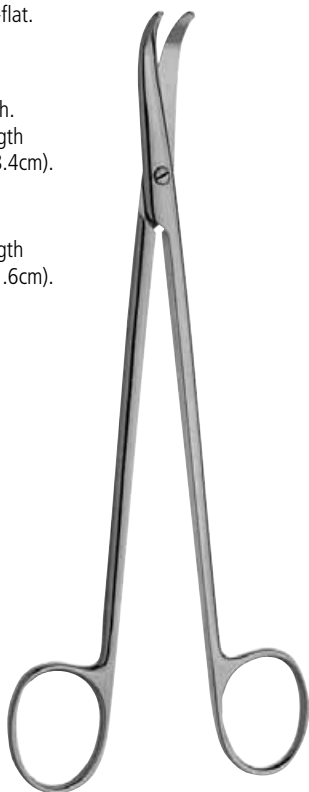

**ROCHESTER-FERGUSON Scissors**

Angled-on-flat.  
Mirror finish.

**SU1952**

Overall length  
7in (17.8cm).



**Fine Scissors**

Sharp/Sharp.  
Blade 25mm.  
Mirror finish.  
Overall length  
4-1/2in (11.4cm).

◆ **SU1791**

Straight.

**SU1796**

Curved.



**Plastic Utility Scissors**

Sharp/Sharp.  
Blades 3.8cm  
from mid-screw.  
Mirror finish.  
Overall length  
5in (12.7cm).

**RH1600**

Straight.

**RH1610**

Curved.



**Suture Scissors**

Blades curved on the side.  
Outer blade notched  
for pick up and  
cutting of sutures.

**SU1972**

Northbent.  
Overall length  
5in (12.7cm).

**SU1973**

Shortbent.  
Overall length  
3-1/2in (8.9cm).



**LITTAUER Stitch Scissors**

Light model.  
Straight.  
Mirror finish.

**SU1970**

Overall length  
5-1/2in (14cm).



**Suture Scissors**

Serrated edges cut without slipping. Straight. Blunt/Blunt. Mirror finish.

◆ **SU1990**

Overall length 4-1/2in (11.4cm).



**NEW'S Suture Scissors**

Angled blades. Blunt/Blunt. Mirror finish.

◆ **SU1950**

Overall length 5-1/2in (14cm).



**Suture Scissors**

Straight. Sharp/Blunt. Mirror finish.

◆ **SU1992**

Overall length 5-3/4in (14.5cm).

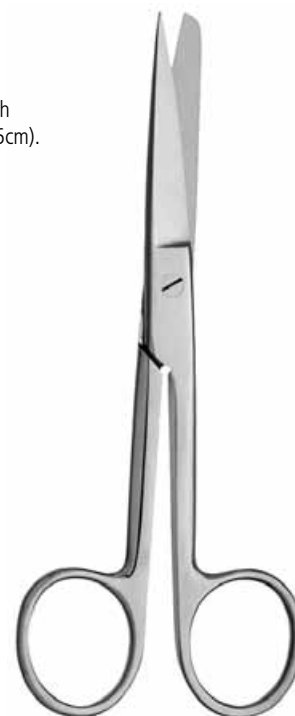

**Wire-Cutting Scissors**

Overall length 4-3/4in (12.1cm).

◆ **SU1980**

Blades angled-to-side.

**SU1985**

Straight blades.

**SU1986**

Curved blades.

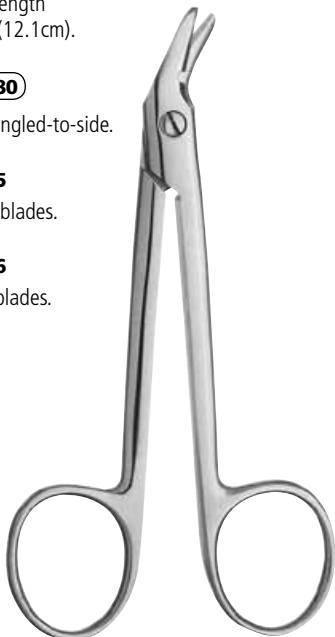

**Vital® Suture Wire-Cutting Scissors**

Stellite® cutting edges. Overall length 5in (12.7cm).

◆ **SU1988**

Angled jaws.



**Sternal Wire Cutter**

Double-action. Replaceable blades.

◆ **CH9100-18**

Overall length 6-3/4in (17.2cm).

**CH9100-50**

Replacement blade only for CH9100-18.



**Scissors**

Ciseaux  
Scheren  
Forbici  
Tijeras  
Tesoura  
鋏

**KNOWLES Bandage Scissors**

Straight, probe point.  
Mirror finish.

**SU2025**

Overall length  
5-1/2in (14cm).



**Universal Bandage Scissors**

Heavy-duty. Autoclavable.  
Mirror finish.

**SU2012-001**

Black plastic handles.  
Overall length  
5-1/2in (14cm).

◆ **SU2014-001**

Black plastic handles.  
Overall length  
7in (18cm).

**SU2014-002**

Blue plastic handles.  
Overall length  
7-1/2in (19.1cm).

**SU2014-003**

Green plastic handles.  
Overall length  
7-1/2in (19.1cm).

**SU2014-004**

Red plastic handles.  
Overall length  
7-1/2in (19.1cm).



**LISTER Bandage Scissors**

Angled, probe point.

**SU2001**

Overall length  
3-1/2in (8.9cm).

**SU2003**

Overall length  
4-1/2in (11.4cm).

◆ **SU2005**

Overall length  
5-1/2in (14cm).

**SU2005-001**

Gold handles.  
Overall length  
5-1/2in (14cm).

◆ **SU2007**

Overall length  
7-1/4in (18.4cm).

◆ **SU2009**

Overall length  
8in (20.3cm).



**Super Cut LISTER Bandage Scissors**

**SU2005-S**

Overall length  
5-3/4in (14.6cm).

◆ **SU2007-S**

Overall length  
7-1/4in (18.4cm).

**SU2009-S**

Large finger ring.  
Overall length  
8in (20.3cm).





Porte-aiguilles  
Nadelhalter  
Porta-ago  
Sostenes de agujas  
Porta-agulhas  
針ホルダー

**DERF Eye Needle Holder**

Straight, serrated, cupped jaws. Light.



**OP7510**

Overall length  
4-3/4in (12.1cm).

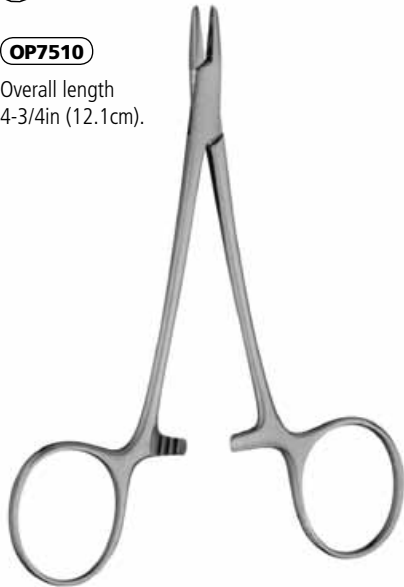

**Vital® DERF Eye Needle Holder**

Tungsten Carbide inserts.  
3,600 teeth per square inch.



**OP7512**

Overall length  
4-3/4in (12.1cm).



**WEBSTER Needle Holders**

Light, with smooth jaws.  
Overall length  
5in (12.7cm).



◆ **RH2560**

**RH2560-MM**  
Mueller-  
Mirror® finish.



**Vital® WEBSTER Needle Holders**

Tungsten Carbide inserts. Overall length  
4-3/4in (12.1cm).



◆ **RH2561**

Smooth jaws.



◆ **RH2562**

3,600 teeth  
per square inch.

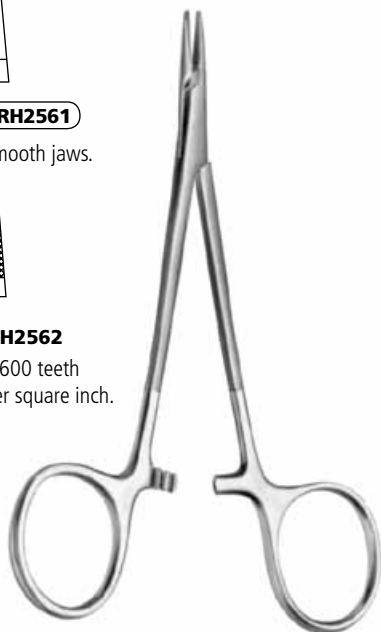

**HALSEY Needle Holder**

Smooth jaws.

**OP7515**

Overall length  
5in (12.7cm).



**Vital® HALSEY Needle Holders**

Tungsten Carbide inserts.  
Overall length 5in (12.7cm).



◆ **OP7511**

3,600 serrations  
per square inch.

**OP7511-001**  
Left-handed.



◆ **OP7513**

Smooth jaws.

**OP7513-001**  
Left-handed.



## Needle Holders

Porte-aiguilles  
Nadelhalter  
Porta-ago  
Sostenes de agujas  
Porta-agulhas  
針ホルダー

### Vital® NEIVERT Needle Holder

One offset ring. Tungsten Carbide inserts.  
3,600 teeth per square inch.



**RH2551**

Overall length  
5in (12.7cm).



### COLLIER Needle Holder

Serrated, fenestrated jaws.



◆ **SU16100**

Overall length  
5in (12.7cm).



### HEGAR-BAUMGARTNER Needle Holder

Serrated jaws.



**SU16080**

Overall length  
5-1/2in (14cm).



### Vital® BAUMGARTNER Needle Holders

Tungsten Carbide inserts.  
2,500 teeth per square inch.



◆ **SU16081**

Overall length  
5-1/8in (13cm).

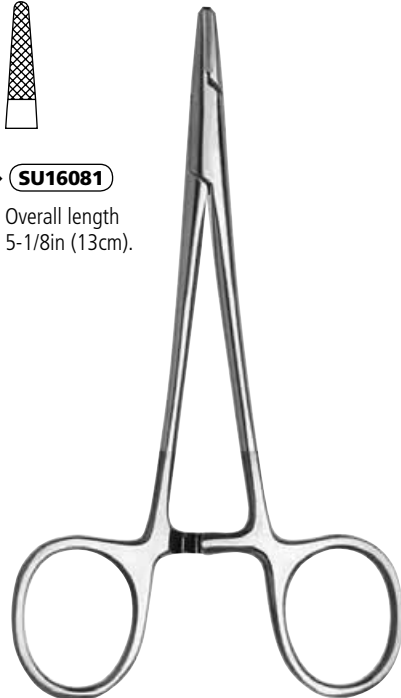

### HEGAR Needle Holders

Narrow jaws.



**SU16020**

Overall length  
6-1/4in (15.9cm).

**SU16025**

Overall length  
7-1/4in (18.4cm).

**SU16030**

Overall length  
8in (20.3cm).

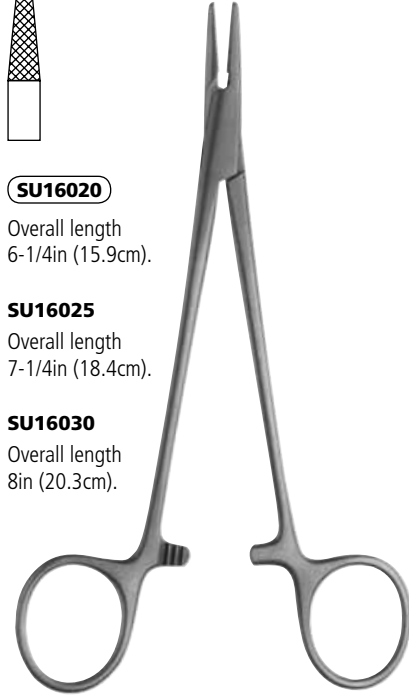

### HEGAR Needle Holders

Stubby jaws.



◆ **SU16026**

Overall length  
7in (17.8cm).

**SU16031**

Overall length  
8in (20.3cm).

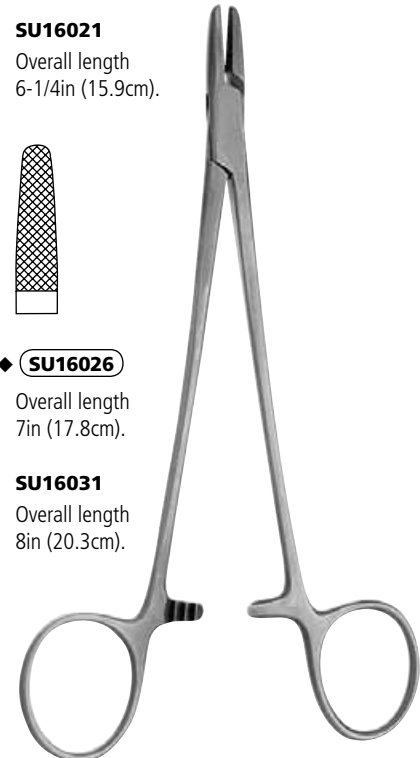

**Vital® CRILE-WOOD Needle Holders**

Tungsten Carbide inserts. 3,600 teeth per square inch.



◆ **CH2419**

Straight.  
Smooth jaws.  
Overall length  
6in (15.2cm).



◆ **CH2423**

Curved.  
Overall length  
7-1/8in (18.1cm).



◆ **SU16005**

Straight.  
Overall length  
6in (15.2cm).

**CH2424**

Straight.  
Overall length  
8in (20.3cm).

**CH2428**

Straight.  
Overall length  
11-3/4in (29.8cm).

◆ **CH2426**

Curved.  
Overall length  
9-1/4in (23.5cm).

**SU16005001**

Curved.  
Left-handed.  
Overall length  
6in (15.2cm).

**CH2425**

Straight.  
Overall length  
9in (22.9cm).

◆ **CH2429**

Straight.  
4 x 4 ratchet.  
Overall length  
14in (35.6cm).

**CH2426-001**

Curved.  
Left-handed.  
Overall length  
9-1/4in (23.5cm).

◆ **CH2422**

Straight.  
Overall length  
7-1/8in (18.1cm).

**CH2427**

Straight.  
Overall length  
10-3/8in (26.3cm).



**Vital® MAYO-HEGAR Needle Holders**

Tungsten Carbide inserts. 2,500 teeth per square inch.



◆ **SU16060**

Overall length  
6-1/4in (15.9cm).



◆ **SU16061**

Overall length  
7-1/4in (18.4cm).



◆ **SU16062**

Overall length  
8in (20.3cm).



◆ **SU16063**

Overall length  
9-1/4in (23.5cm).

**SU16060001**

Left-handed.  
Overall length  
6-1/4in (15.9cm).

**SU16061001**

Left-handed.  
Overall length  
7in (17.8cm).

**SU16062001**

Left-handed.  
Overall length  
8in (20.3cm).



◆ **CH2435**

Overall length  
11-3/4in (29.8cm).



**CH2437**

Overall length  
14in (35.6cm).



**SU16180**

Overall length  
16in (41cm).



**CH2438**

Double-action  
box locks.  
Overall length  
18in (45.7cm).



**Needle Holders**

Porte-aiguilles  
Nadelhalter  
Porta-ago  
Sostenes de agujas  
Porta-agulhas  
針ホルダー

**FINOCHIETTO Needle Holder**

Straight jaws.



**CH2460**

Overall length  
8in (20.3cm).



**Vital® FINOCHIETTO Needle Holders**

Tungsten Carbide inserts.  
3,600 teeth per square inch.



**CH2461**

Overall length  
8in (20.3cm).



**CH2471**

Overall length  
10-1/2in (26.7cm).

**SAROT Needle Holders**

Indented shanks. Straight jaws.



**CH2415**

Overall length  
7-1/8in (18.1cm).



**CH2410**

Overall length  
10-1/4in (26cm).



**Vital® SAROT Needle Holders**

Tungsten Carbide inserts.  
3,600 teeth per square inch.



◆ **CH2416**

Overall length  
7-1/8in (18.1cm).



**CH2411**

Overall length  
10-3/8in (26.3cm).



Porte-aiguilles  
Nadelhalter  
Porta-ago  
Sostenes de agujas  
Porta-agulhas  
針ホルダー

**MASSON Needle Holder**



**CH2440**

Overall length  
10-1/2in (26.7cm).



**Vital® MASSON Needle Holder**

Tungsten Carbide inserts.  
2,500 teeth per square inch.



**CH2442**

Overall length  
10-3/8in (26.3cm).



**HEANEY Needle Holder**

Curved.



◆ **SU16120**

Overall length  
8-1/4in (21cm).

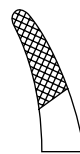

◆ **SU16122**

Overall length  
8in (20.3cm).



**SU16124**

Overall length  
10-1/2in (26.7cm).



**SU16126**

Overall length  
12in (30.5cm).



**SU16128**

Overall length  
14in (35.6cm).

**Vital® HEANEY Needle Holders**

Curved. Tungsten Carbide inserts. 2,500 teeth per square inch.

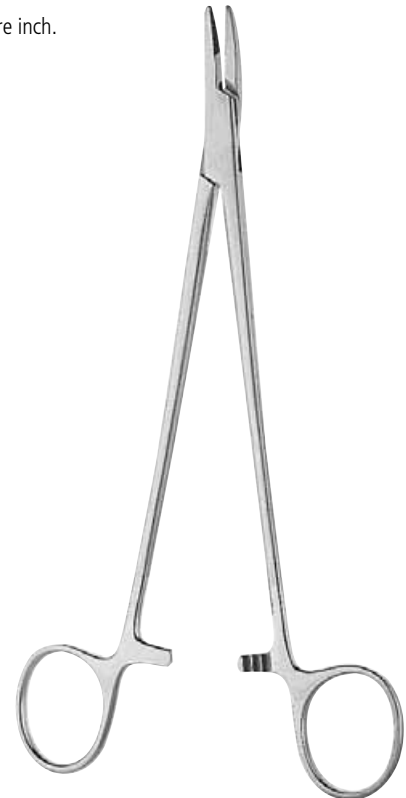

**Needle Holders**

Porte-aiguilles  
Nadelhalter  
Porta-ago  
Sostenes de agujas  
Porta-agulhas  
針ホルダー

**STRATTE Needle Holder**

Double bend.  
Curved jaws.

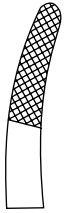

**SU16140**

Overall length  
9in (22.9cm).

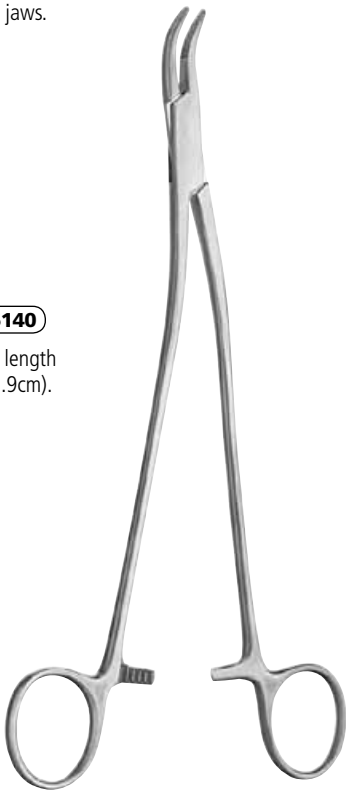

**Vital® STRATTE Needle Holders**

Double bend, curved jaws.  
Tungsten Carbide inserts.  
3,600 teeth per square inch.

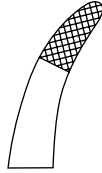

**SU16141**

Curved.  
Overall length  
9in (22.9cm).



**SU16143**

Delicate.  
Reverse curved.  
Overall length  
9-1/4in (23.5cm).



**SU16142**

Delicate.  
Curved.  
Overall length  
9-1/4in (23.5cm).

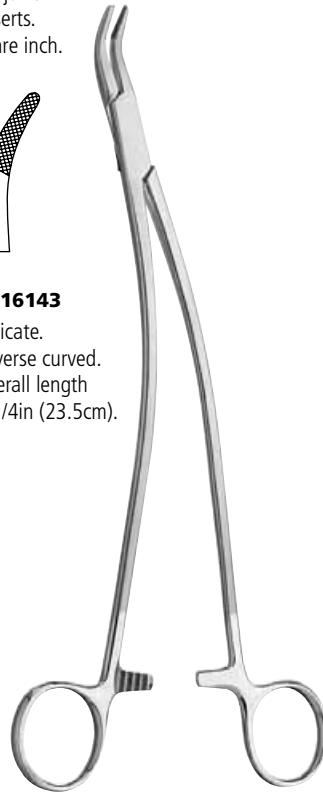

**WANGENSTEEN Needle Holder**

Straight jaws.



**SU16150**

Overall length  
10-1/4in (26cm).

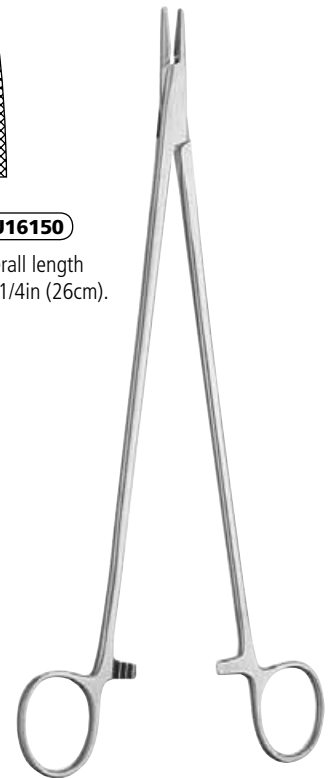

**WANGENSTEEN Needle Holder**

Straight jaw.



**CH2432**

Overall length  
10-3/4in (27.3cm).

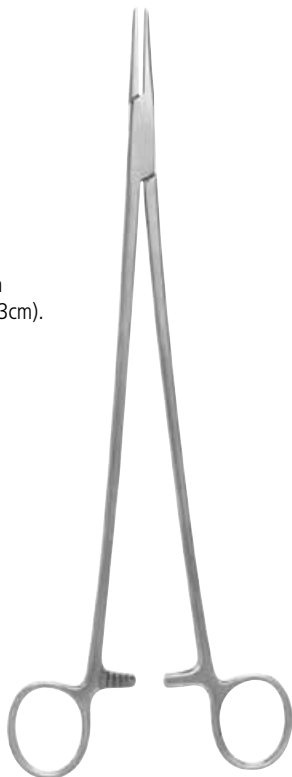

**Vital® WANGENSTEEN Needle Holder**

Straight jaws.  
Tungsten Carbide inserts.  
3,600 teeth per square inch.



**CH2433**

Overall length  
10-3/4in (27.3cm).

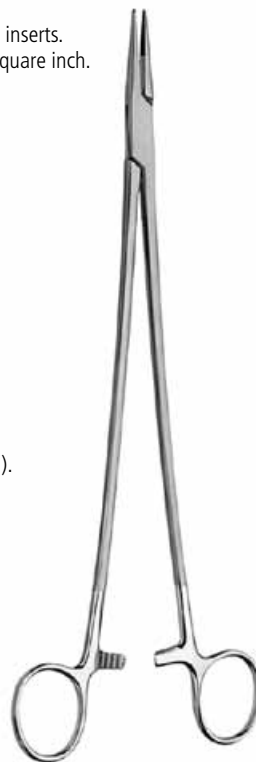

**MAYO-HEGAR Needle Holder**

Extra-long. Heavy.



**SU16160**

Overall length  
14in (35.6cm).



Porte-aiguilles  
Nadelhalter  
Porta-ago  
Sostenes de agujas  
Porta-agulhas  
針ホルダー

**Vital® OLSEN-HEGAR Needle Holders**

Cutting edge. Tungsten Carbide inserts.  
2,500 teeth per square inch.



◆ **SU16252**

Overall length  
5-3/4in (14.6cm).

**SU16253**

Overall length  
7-1/4in (18.4cm).



**NEW ORLEANS Needle Holder**

Stubby jaws.



**SU16090**

Overall length  
7in (17.8cm).



**Vital® NEW ORLEANS Needle Holder**

Tungsten Carbide inserts.  
2,500 teeth per square inch.



**SU16091**

Overall length  
7in (17.8cm).



**MATHIEU Needle Holder**

Frictionless spring.

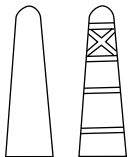

**SU16200**

Overall length  
8in (20.3cm).



**Vital® MATHIEU Needle Holder**

Tungsten Carbide inserts.  
2,500 teeth per square inch.



**SU16254**

Overall length  
8in (20.3cm).



**Needle Holders**

Porte-aiguilles  
Nadelhalter  
Porta-ago  
Sostenes de agujas  
Porta-agulhas  
針ホルダー

**GRANT Needle Holder**

Straight jaws, combined with suture scissors.



**SU16250**

Overall length 6-1/2in (16.5cm).



**GARDNER Needle Holder**



**SU16085**

Overall length 6in (15.2cm).



**Vital® French Eye Needle Holders**

Tungsten Carbide inserts. 2,500 teeth per square inch.

**SU16145**

Overall length 6-1/4in (15.9cm).



**SU16146**

Overall length 7-1/4in (18.4cm).

**SU16147**

Overall length 8in (20.3cm).



**SU16148**

Overall length 10-1/4in (26cm).

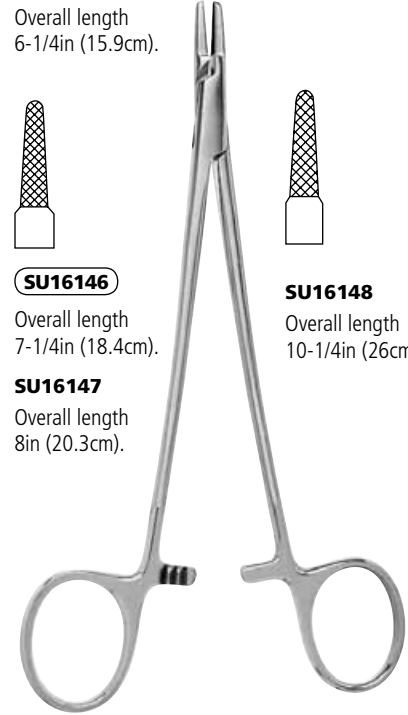

**Vital® JULIAN Needle Holders**

Light and delicate. Tungsten Carbide inserts. 3,600 teeth per square inch. Overall length 8in (20.3cm).



**CH2420**

Straight jaws.



**CH2421**

Curved jaws.



**Vital® NOLAN Needle Holder**

Tungsten carbide inserts. 2,500 teeth per square inch.



**SU16210**

Overall length 14in (35.6cm).





**Dressing Forceps**

Serrated.

**SU2300**

Overall length  
4-3/4in (12.1cm).

**SU2303**

Overall length  
6in (15.2cm).

**SU2301**

Overall length  
5in (12.7cm).

**SU2303-MM**

Mueller-Mirror® finish.

**SU2301-MM**

Mueller-Mirror® finish.

**SU2305**

Overall length  
8in (20.3cm).

**SU2302**

Overall length  
5-1/2in (14cm).

**SU2306**

Overall length  
9in (22.9cm).

**SU2302-MM**

Mueller-Mirror® finish.

**SU2307**

Overall length  
10in (25.4cm).

**SU2309**

Overall length  
12in (30.5cm).



**Dressing Forceps**

Curved, serrated.

**SU2315**

Overall length  
5-1/2in (14cm).



**Tissue Forceps**

1 x 2 teeth.

**SU2330**

Overall length  
4-5/8in (11.7cm).

◆ **SU2333**

Overall length  
6in (15.2cm).

**SU2331**

Overall length  
5in (12.7cm).

**SU2333-MM**

Mueller-Mirror®  
finish.

◆ **SU2332**

Overall length  
5-3/4in (14.6cm).

**SU2335**

Overall length  
8in (20.3cm).

**SU2338**

Overall length  
12in (30.5cm).

**SU2332-MM**

Mueller-  
Mirror® finish.

**SU2337**

Overall length  
10in (25.4cm).

**SU2312**

Overall length  
16in (40.6cm).



**Tissue Forceps**

2 x 3 teeth.

**SU2340**

Overall length  
4-1/2in (11.4cm).

**SU2341**

Overall length  
5in (12.7cm).

**SU2342**

Overall length  
5-1/2in (14cm).

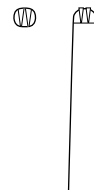

**SU2343**

Overall length  
6in (15.2cm).



**Forceps**

Forceps  
Zangen  
Pinze  
Fórcexs  
Fórcexs  
鉗子

**Tissue Forceps**

3 x 4 teeth.



**SU2350**

Overall length  
5in (12.7cm).

**SU2351**

Overall length  
5-1/2in (14cm).

**SU2352**

Overall length  
6in (15.2cm).



**Tissue Forceps**

4 x 5 teeth.

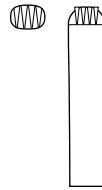

**SU2361**

Overall length  
5-1/2in (14cm).

**SU2362**

Overall length  
6in (15.2cm).



**Tissue Forceps**

1 x 2 teeth with serrations.



**SU2380**

Overall length  
6in (15.2cm).



**WALTHER Tissue Forceps**

1 x 2 teeth. Mirror and  
Satin finish.



**SU2400**

Overall length  
6in (15.2cm).



**BROPHY Dressing Forceps**

Also for removing sutures.  
Delicate, serrated.



**MO500**

Overall length  
6-1/4in (15.9cm).



**CASSIDY-BROPHY Dressing Forceps**

Broader than the fine  
BROPHY model, but  
narrower and lighter  
than regular dressing  
forceps. Delicate.

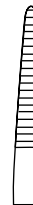

**MO502**

Overall length  
6-1/4in (15.9cm).



**CASSIDY-BROPHY Dressing Forceps**

Delicate.



**SU2375**

Overall length  
8in (20.3cm).



**CARMODY Tissue Forceps**

Fine serrations on jaws.  
1 x 2 teeth.  
Mirror finish.

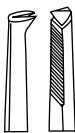

**MO510**

Overall length  
6-1/4in (15.9cm).



**SEMKEN Dressing Forceps**

Delicate, serrated.  
Mirror finish.



**SU2370**

Overall length  
4-7/8in (12.4cm).



**SEMKEN Tissue Forceps**

Delicate. Mirror finish.  
1 x 2 teeth.



**SU2371**

Overall length  
4-7/8in (12.4cm).



**BROWN-BAHNSON Forceps**

Bayonet.  
Mirror finish.



**SU2505**

Overall length  
6in (15.2cm).

**SU2506**

Overall length  
8in (20.3cm).



**MILLS Tissue Forceps**

2 x 3 teeth.



**MO515**

Overall length  
7in (17.8cm).



**Forceps**

Forceps  
Zangen  
Pinze  
Fórcexs  
Fórcexs  
鉗子

**ADSON Forceps**

Delicate. 1 x 2 teeth with serrations.

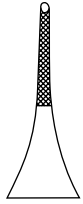

◆ **NL1400**

Overall length  
4-3/4in (12.1cm).

**NL1400-MM**

Mueller-Mirror® finish.



**ADSON Micro Forceps**

Especially delicate jaws.



**NL1401**

Serrated jaws.  
Overall length  
4-3/4in (12.1cm).



◆ **NL1411**

1 x 2 teeth.  
Overall length  
4-3/4in (12.1cm).



**ADSON Dressing Forceps**

Serrated.

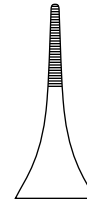

◆ **NL1410**

Overall length  
4-3/4in (12.1cm).

**NL1410-MM**

Mueller-Mirror® finish.



**Vital® ADSON Tissue Forceps**

Tungsten Carbide inserts.  
3,600 teeth per square inch.



◆ **NL1415**

Overall length  
4-3/4in (12.1cm).

**NL1412**

1 x 2 teeth.  
Overall length  
4-3/4in (12.1cm).

**NL1416**

1 x 2 teeth.  
Overall length  
6in (15.2cm).



**ADSON Dressing Forceps**

Slender, cross-serrated.



**NL1490**

Overall length  
6-1/4in (16cm).



**ADSON Dressing Forceps**

Bayonet. Fine, serrated tips.

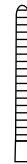

**NL1550**

Overall length  
7-1/8in (18.1cm).



**HUDSON Dressing Forceps**

Overall length  
4-7/8in (12.4cm).

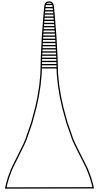

**SU2390**

Serrated.

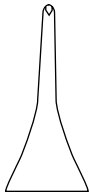

**SU2391**

1 x 2 teeth.



**BROWN-ADSON Tissue Forceps**



◆ **SU2504**

Overall length  
4-7/8in (12.4cm).



**FARRIS Tissue Forceps**

1 x 2 teeth, with serrations.  
Mirror finish.



**SU2410**

Overall length  
8-7/8in (22.5cm).



**ROCHESTER-EWALD Tissue Forceps**

1 x 2 teeth, with serrations.  
Mirror and Satin finish.



**SU2420**

Overall length  
6-3/4in (17.1cm).



**ROCHESTER Tissue Forceps**  
RUSSIAN-style tip.



**SU2448**

Overall length  
6in (15.2cm).



**RUSSIAN Tissue Forceps**



**SU2450**

Overall length  
6in (15.2cm).

**SU2452**

Overall length  
8in (20.3cm).

**SU2454**

Overall length  
10in (25.4cm).

**SU2456**

Overall length  
12in (30.5cm).

**SU2458**

Overall length  
14in (35.6cm).



**Forceps**

Forceps  
Zangen  
Pinze  
Fórceps  
Fórceps  
鉗子

**C. W. MAYO Tissue Forceps**

Fenestrated. RUSSIAN-style tip.  
Rugged, non-perforating teeth  
and deeply serrated handles.  
Mirror finish.

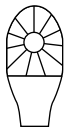

**SU2460**

Overall length  
9in (22.9cm).



**MAYO-RUSSIAN Tissue Forceps**

Rugged, non-perforating teeth  
surround the perforated jaws.  
Deeply serrated handles.



**CH1520**

Overall length  
14in (35.6cm).



**LOVELACE Hemostatic Tissue Forceps**

Serrated. Kynar®-coated  
insulated handles.



**SU2550**

Overall length  
7-3/4in (19.7cm).



**STILLE-Type Tissue Forceps**

4 x 5 teeth.

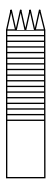

**SU2480**

Overall length  
5in (12.7cm).



**MARTIN Tissue Forceps**

7 x 8 teeth. Mirror finish.



**SU2490**

Overall length  
6in (15.2cm).

**SU2491**

Overall length  
7in (17.8cm).



**BROWN Tissue Forceps**

7 x 8 teeth.



**SU2500**

Overall length  
6-1/8in (15.6cm).

**SU2502**

Overall length  
8in (20.3cm).



**FERRIS SMITH Tissue Forceps**

Mirror and Satin finish.  
Overall length  
6-3/4in (17.1cm).



◆ **SU2510**  
2 x 3 teeth.  
Heavy.



◆ **SU2511**  
1 x 2 teeth.



**HEANEY Tissue Forceps**

Mirror and Satin finish.

**SU2520**

2 x 3 teeth. Overall length  
5-1/2in (14cm).

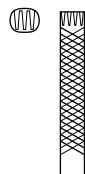

**SU2525**  
3 x 4 teeth.  
Overall length  
7-1/2in (19.1cm).

**SU2526**  
1 x 2 teeth.  
Overall length  
7-1/2in (19.1cm).



**WANGENSTEEN Tissue Forceps**



**SU5070**  
Overall length  
9-1/2in (24.1cm).



**Vital® WANGENSTEEN Tissue Forceps**

Tungsten Carbide inserts.  
2,500 teeth per square inch.



**SU5071**  
Overall length  
6in (15.2cm).



**SU5072**  
Overall length  
9in (22.9cm).

**SU5073**  
Overall length  
10in (25.4cm).



**SINGLEY Tissue Forceps**

Fenestrated, serrated jaws.  
Mirror finish.



**SU5075**  
Overall length  
9-3/4in (24.8cm).

**SU5076**  
Overall length  
14in (35.6cm).

**SU5078**  
Overall length  
16in (40.6cm).



**TUTTLE-SINGLEY Tissue Forceps**

**SU5060**  
Overall length  
6in (15.2cm).

**SU5065**  
Overall length  
7in (17.8cm).



**Forceps**

Forceps  
Zangen  
Pinze  
Fórceps  
Fórceps  
鉗子

**GLASSMAN Non-Crushing Pick-Up Forceps**

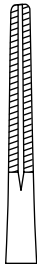

**SU6195**

Overall length  
6-1/4in (15.9cm).



**GLASSMAN Non-Crushing Pick-Up Forceps**



**SU6180**

Overall length  
6-1/4in (15.9cm).



**GLASSMAN Non-Crushing Pick-Up Forceps**



**SU6190**

Overall length  
8-3/4in (22.2cm).



**GLASSMAN Non-Crushing Pick-Up Forceps**

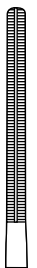

**SU6198**

Overall length  
9in (22.9cm).



**GILLES Tissue Forceps**

1 x 2 teeth.

**NL1492**

Overall length  
6in (15.2cm).



**WAUGH Tissue Forceps**

**NL1475**

Serrated jaws.  
Overall length  
8in (20.3cm).

**NL1476**

1 x 2 teeth.  
Overall length  
8in (20.3cm).





**KELLY Tissue Forceps**  
3 x 4 teeth. Mirror and Satin finish.

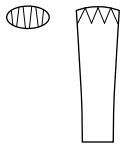

**SU2530**

Overall length  
8-5/8in (22cm).



**STONE Tissue Forceps**  
4 x 5 teeth.

**SU2535**

Overall length  
6in (15.2cm).



**CURTIS Tissue Forceps**  
1 x 2 teeth, with serrations.  
Heavy. Matte and Mirror finish.



◆ **SU2540**

Overall length  
8-3/4in (22.2cm).



**BAKER Tissue Forceps**  
Modified BONNEY-type.  
1 x 2 teeth, with serrations.  
Matte and Mirror finish.

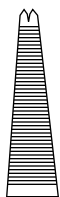

**SU2541**

Overall length  
7-1/2in (19.1cm).



**BONNEY Tissue Forceps**  
1 x 2 teeth.

◆ **SU2542**

Overall length  
6-3/4in (17.1cm).



**Vital® Tissue Forceps**  
Cross-serrated jaws.  
Tungsten Carbide inserts.  
2,500 teeth per square inch.



**SU2250**

Overall length  
6in (15.2cm).



**Forceps**

Forceps  
Zangen  
Pinze  
Fórcps  
Fórcps  
鉗子

**Vital® CUSHING Tissue Forceps**

Straight. Delicate jaws.  
Tungsten Carbide inserts.  
3,600 teeth per square inch.



**NL1460**

Overall length  
7in (17.8cm).



**Vital® CUSHING Tissue Forceps**

Angled tips. Tungsten Carbide inserts.  
3,600 teeth per square inch.

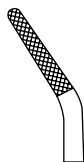

**NL1462**

Overall length  
6-3/4in (17cm).



**Vital® CUSHING Tissue Forceps**

Bayonet. Tungsten Carbide tips  
and dissecting end.



**NL1464**

Overall length  
7-1/4in (18.5cm).



**Vital® EVANS Tissue Forceps**

Tungsten Carbide inserts.  
2,500 teeth per square inch.



**SU2465**

Overall length  
9-3/4in (24.9cm).



**PIERSE-Type Jewelers Tissue Forceps**

Straight. Flat handle, 9mm wide.



**CH13104**

Tip with 0.3mm-  
diameter hole.  
Overall length  
5-1/4in (13.5cm).

**CH13106**

Tip with 0.6mm-  
diameter hole.  
Overall length  
4-3/8in (11cm).

**CH13108**

Tip with 0.3mm-  
diameter hole.  
Overall length  
7in (18cm).

**CH13105**

Tip with 0.3mm-  
diameter hole.  
Overall length  
4-3/8in (11cm).

**CH13107**

Tip with 0.6mm-  
diameter hole.  
Overall length  
7in (18cm).

**CH13109**

Tip with 0.1mm-  
diameter hole.  
Overall length  
7in (18cm).



**Jewelers Forceps**

Straight.



**CH13110**

Tip diameter 0.3mm.  
Flat handle, 7mm wide.  
Overall length  
5-1/4in (13.5cm).

**CH13087**

Tip diameter 0.3mm.  
Flat handle, 9mm wide.  
Overall length  
4-3/8in (11cm).

**CH13082**

Tip diameter 0.3mm.  
Flat handle, 9mm wide.  
Overall length  
4-3/4in (12cm).

**CH13100**

Tip diameter 0.3mm.  
Flat handle, 9mm wide.  
Overall length  
5-1/4in (13.5cm).

**CH13088**

Tip diameter 0.3mm.  
Flat handle, 9mm wide.  
Overall length  
5-1/2in (14cm).

**CH13083**

Tip diameter 0.3mm.  
Flat handle, 9mm wide.  
Overall length  
7in (18cm).

**CH13086**

Tip diameter 0.4mm.  
Flat handle, 9mm wide.  
Overall length  
4-1/4in (10.8cm).

**CH13081**

Tip diameter 0.6mm.  
Flat handle, 9mm wide.  
Overall length  
4-3/4in (12cm).

**CH13080**

Tip diameter 0.8mm.  
Flat handle, 9mm wide.  
Overall length  
4-3/4in (12cm).



**Jewelers Forceps**

Straight. With tying platform.  
Tip diameter 0.3mm.



**CH13112**

Flat handle, 7mm wide.  
Overall length  
5-1/4in (13.5cm).

**CH13103**

Flat handle, 9mm wide.  
Overall length  
5-1/4in (13.5cm).

**CH13089**

Flat handle, 9mm wide.  
Overall length  
5-1/2in (14cm).

**CH13085**

Flat handle, 9mm wide.  
Overall length  
7in (18cm).



**Jewelers Forceps**

Tip diameter 0.3mm.



**CH13095**

Tip angled 40°.   
Flat handle, 9mm wide.  
Overall length  
5-1/4in (13.5cm).

**CH13094**

Tip angled 40°.   
Flat handle, 9mm wide.  
Overall length  
7in (18cm).

**CH13091**

Tip angled 45°.   
Flat handle, 9mm wide.  
Overall length  
4-3/8in (11cm).

**CH13093**

Tip angled 45°.   
Flat handle, 9mm wide.  
Overall length  
5-1/4in (13.5cm).

**CH13098**

Tip angled 45°.   
Flat handle, 8mm wide.  
Overall length  
5-7/8in (15cm).

**CH13097**

Tip angled 45°.   
Flat handle, 7mm wide.  
Overall length  
5-1/4in (13.5cm).



**Forceps**

Forceps  
Zangen  
Pinze  
Fórcexs  
Fórcexs  
鉗子

**Jeweler-Type Forceps**

Straight.

**NL1424**

Overall length  
4-3/4in (12.1cm).

**NL1425**

Overall length  
5-1/4in (13.3cm).



**Jeweler-Type Micro Forceps**

Straight.

Overall length  
4-3/8in (11.1cm).

**NL1420**

Extra-fine tips,  
smooth spring action.

**NL1421**

Fine tips.



**Jeweler-Type Micro Forceps**

Curved, fine tips.

**NL1422**

Overall length  
4-1/2in (11.4cm).



**Pick-up Forceps**

Delicate, jeweler-type  
with angled tips.

**NL1423**

Overall length  
4-3/8in (11.1cm).



**Microsurgical Forceps**

Counterbalanced.

Round handle.

Overall length  
5-7/8in (15cm).

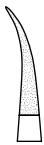

**CH13157**

Curved.  
Tip diameter 0.3mm.

**CH13158**

Straight.  
Tip diameter 0.3mm.

**CH13159**

Straight.  
Tip diameter 0.5mm.

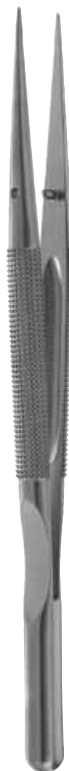

**Micro Tissue Forceps**

Straight. PIERSE-type tip  
with 0.3mm-diameter hole.  
Round handle.



**CH13174**

Overall length  
5-7/8in (15cm).

**CH13175**

Overall length  
7in (18cm).



**Micro Tissue Forceps**

Counterbalanced.

PIERSE-type tip with  
0.3mm-diameter hole.  
Round handle.



**CH13160**

Overall length  
7in (17.8cm).



**Micro Tissue Forceps**

Straight tip, width 1mm.  
Tungsten Carbide inserts.  
Round handle.

**CH13176**

Overall length  
7in (18cm).

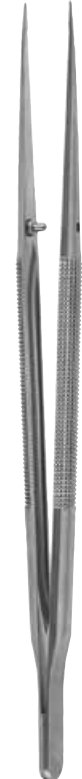

**PENFIELD Watchmaker Forceps**

**NL1525**

Overall length  
7in (17.8cm).



**Dilator Forceps**

**CH13111**

Straight. Tip diameter 0.2mm.  
Flat handle, 7mm wide.  
Overall length 5-1/4in (13.5cm).

**CH13084**

Straight. Tip diameter 0.2mm.  
Flat handle, 9mm wide.  
Overall length 7in (18cm).

**CH13150**

Tip angled 10°, diameter 0.2mm.  
Flat handle, 9mm wide.  
Overall length 4-3/8in (11cm).



**CH13149**

Tip angled 10°, diameter 0.3mm.  
Flat handle, 9mm wide.  
Overall length 4-3/8in (11cm).



**Dilator Forceps**

Flat handle. Tip angled  
45°, diameter 0.3mm.



**CH13096**

Overall length  
5-1/4in (13.5cm).



**Dilator Forceps**

Straight. Flat handle.  
Overall length  
5-1/4in (13.5cm).



**CH13101**

Tip diameter  
0.3mm.

**CH13102**

Tip diameter  
0.2mm.



**Splinter Forceps**

Sharp, serrated tips, delicate.

**SU2600**

Overall length  
3in (7.6cm).

**SU2601**

Overall length  
3-1/2in (8.9cm).

**SU2602**

Overall length  
4-1/2in (11.4cm).



**WALTER Splinter Forceps**

Triangular tips, delicate.  
Overall length 4in (10.2cm).

**SU2610**

Straight.

**SU2611**

Angled.



**FEILCHENFELD Splinter Forceps**

Serrated, cupped tips, delicate.

**SU2620**

Overall length  
3in (7.6cm).

**SU2621**

Overall length  
4-1/2in (11.4cm).



## Forceps

Forceps  
Zangen  
Pinze  
Fórceps  
Fórceps  
鉗子

### Physician's Splinter Forceps

**SU2640**

Overall length  
5in (12.7cm).



### VIRTUS Splinter Forceps

**SU2630**

Overall length  
6in (15.2cm).



Snowden-Pencer laparoscopic ergonomic take-apart instruments can be taken apart to enhance visual inspection during cleaning—helping support sterility. Assembly and disassembly are easy, with instrument markers and cues to guide the way.

Features designed to make assembly easy

CareFusion has built several features into our Snowden-Pencer take-apart instruments to make them easier to assemble and disassemble. Among these features, the:

- Double buttons are easy to grip, which aids assembly and disassembly while preventing the instrument from inadvertently disengaging
- Alignment guide provides visual cues to confirm assembly
- Durable insert and shaft help ensure a strong connection and reduce downtime and repairs

To see the Snowden-Pencer laparoscopic ergonomic take-apart instruments in action, visit [carefusion.com/takeapart](https://www.carefusion.com/takeapart)

### Customer Support

Our highly trained, centralized V. Mueller customer support team is available to take your calls from 7:00 a.m. to 6:00 p.m. (CST), M-F. This group is dedicated to providing a full range of support services, including:

- Order placement
- Order inquiries
- Delivery information
- Product information
- Pricing inquiries

If we can be of assistance, please call us at **800.323.9088**.

### HALSTED Micro-Line® Artery Forceps

Delicate. Overall length  
5in (12.7cm).



**SU2698**

Straight jaws.

**SU2698-MM**

Mueller-Mirror® finish.



◆ **SU2699**

Curved jaws.

**SU2699-MM**

Mueller-Mirror® finish.



### HARTMAN Mosquito Forceps

Delicate jaws. Overall length 4in (10.2cm).

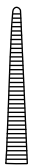

◆ **OP7550**

Straight jaws.

**OP7550-MM**

Mueller-Mirror® finish.



◆ **OP7551**

Curved jaws.

**OP7551-MM**

Mueller-Mirror® finish.



### HALSTED Mosquito Forceps

Overall length 5in (12.7cm).



◆ **SU2700**

Straight jaws.

**SU2700-MM**

Straight.  
Mueller-Mirror® finish.



◆ **SU2702**

Curved jaws.

**SU2702-MM**

Curved.  
Mueller-Mirror® finish.



**Hemostats**

Pinces hémostatiques  
 Gefäßklemmen (Hämostat)  
 Pinze emostatische  
 Hemostatos  
 Pinças hemostáticas  
 止血剂

**HALSTED Mosquito Forceps**

1 x 2 teeth. Overall length 4-3/4in (12.2cm).

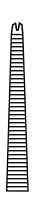

**SU2705**

Straight.



**SU2707**

Curved.



**PROVIDENCE HOSPITAL Artery Forceps**

Overall length 5-1/2in (14cm).



**SU2710**

Straight.



**SU2712**

Curved.



**KELLY Artery Forceps**

Overall length 5-1/2in (14cm).



◆ **SU2720**

Straight.

**SU2720-MM**

Mueller-Mirror® finish.



◆ **SU2722**

Curved.

**SU2722-MM**

Mueller-Mirror® finish.



**COLLER Artery Forceps**

CRILE-type forceps. Delicate.



**SU2723**

Straight.  
 Overall length 5-1/2in (14cm).

**SU2725**

Straight.  
 Overall length 6-1/4in (15.9cm).

**SU2727**

Straight.  
 Overall length 7-1/4in (18.4cm).



**SU2724**

Curved.  
 Overall length 5-1/2in (14cm).

◆ **SU2726**

Curved.  
 Overall length 6-1/4in (15.9cm).

**SU2728**

Curved.  
 Overall length 7-1/4in (18.4cm).





Pinces hémostatiques  
 Gefäßklemmen (Hämostat)  
 Pinze emostatiche  
 Hemostatos  
 Pinças hemostáticas  
 止血剂

**COLLER Artery Forceps**

Jaw length 44mm, tip 2mm.  
 Overall length 9-1/2in (24.1cm).

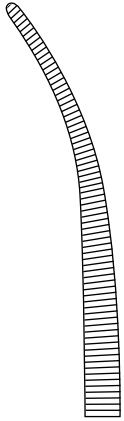

**SU2782**  
 Curved.

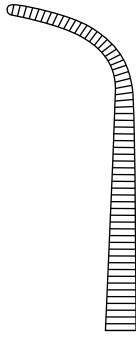

**SU2784**  
 Strongly curved.

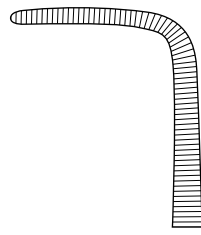

**SU2786**  
 Jaws angled 90°.

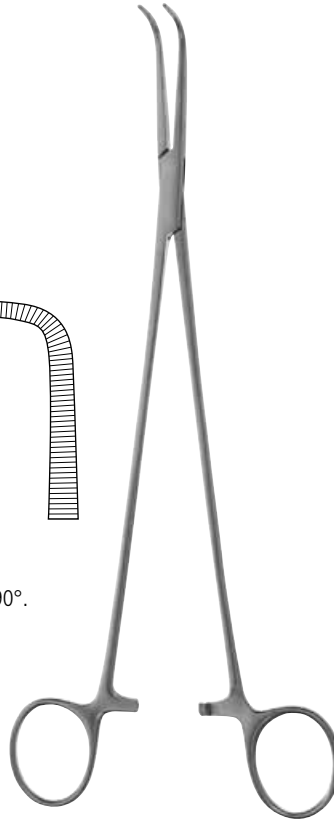

**COLLIER-ANDERSON Clamps**

Curved.

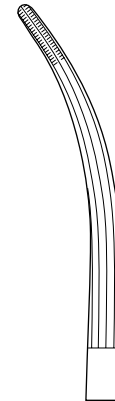

**SU2745**  
 Overall length  
 10in (25.4cm).

**SU2746**  
 Overall length  
 11in (27.9cm).



**BOETTCHER (SCHNIDT) Artery Forceps**

Slightly curved jaws.



◆ **MO1700**  
 Overall length  
 7-1/2in (19cm).



**CRILE Micro-Line® Artery Forceps**

Delicate. Overall length  
 5-1/2in (14cm).



**SU2729**  
 Straight.



**SU2734**  
 Curved.

**SU2734-MM**  
 Mueller-Mirror® finish.



**Hemostats**

Pinces hémostatiques  
Gefäßklemmen (Hämostat)  
Pinze emostatische  
Hemostatos  
Pinças hemostáticas  
止血剂

**CRILE Forceps**

Regular pattern.

◆ **SU2730**

Straight. Overall length  
5-1/2in (14cm).

**SU2730-MM**

Mueller-Mirror® finish.

◆ **SU2732**

Straight. Overall length  
6-1/4in (15.9cm).

**SU2732-MM**

Mueller-Mirror® finish.

◆ **SU2735**

Curved. Overall length  
5-1/2in (14cm).

**SU2735-MM**

Mueller-Mirror® finish.

◆ **SU2737**

Curved. Overall length  
6-1/4in (15.9cm).

**SU2737-MM**

Mueller-Mirror® finish.

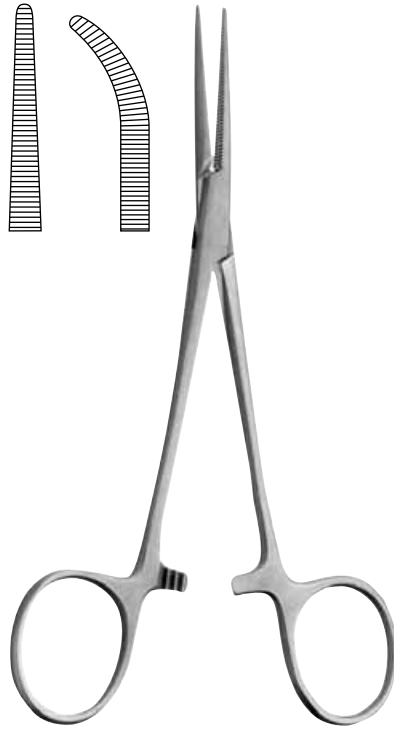

**ROCHESTER-RANKIN Artery Forceps**

Straight.

Light, with finely  
pointed jaws.



**SU2740**

Overall length  
6-1/4in (15.9cm).



**RANKIN Artery Forceps**

Curved.

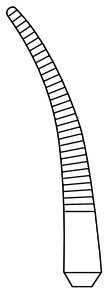

**SU2742**

Overall length  
6-1/4in (15.9cm).

**SU2742-MM**

Mueller-  
Mirror® finish.



**PEAN Micro-Line® Artery Forceps**

Delicate. Overall length 5-1/2in (14cm).

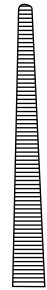

**SU2749**

Straight.



**SU2759**

Curved.



**PEAN Artery Forceps**



**SU2750**

Straight. Overall length 6-1/2in (16.5cm).

**SU2750-MM**

Mueller-Mirror® finish.

**SU2752**

Straight. Overall length 7-1/4in (18.4cm).

**SU2752-MM**

Mueller-Mirror® finish.

**SU2754**

Straight. Overall length 8in (20.3cm).

**SU2754-MM**

Mueller-Mirror® finish.

**SU2758**

Straight. Overall length 12in (30.5cm).

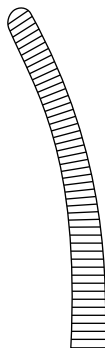

◆ **SU2760**

Curved. Overall length 6-1/2in (16.5cm).

**SU2760-MM**

Mueller-Mirror® finish.

◆ **SU2762**

Curved. Overall length 7-1/4in (18.4cm).

**SU2762-MM**

Mueller-Mirror® finish.

◆ **SU2764**

Curved. Overall length 8in (20.3cm).

**SU2764-MM**

Mueller-Mirror® finish.

**SU2768**

Curved. Overall length 12in (30.5cm).

**SU2769**

Curved. Overall length 14in (35.6cm).



**ROCHESTER-PEAN Forceps**

Serrated.

**GL3200**

Straight. Overall length 8-7/8in (22.5cm).

**GL3201**

Straight. Overall length 10in (25.4cm).

◆ **GL3210**

Curved. Overall length 8-7/8in (22.5cm).

**GL3211**

Curved. Overall length 10in (25.4cm).

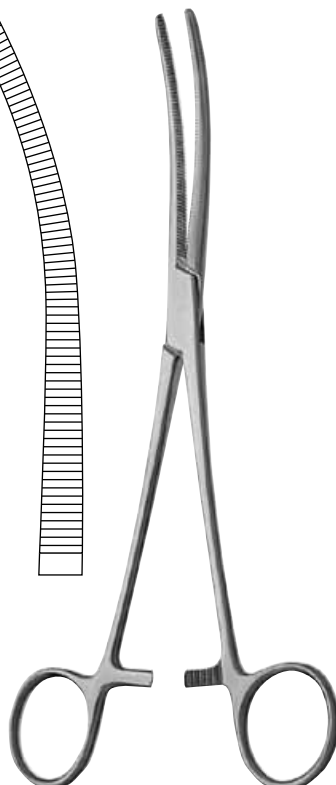
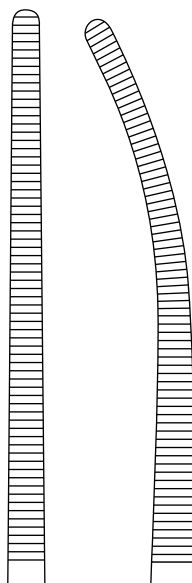

○ Instrument pictured

**CARMALT Artery Forceps**

**SU2770**

Straight. Overall length 6-1/2in (16.5cm).

**SU2772**

Straight. Overall length 8in (20.3cm).

**SU2775**

Curved. Overall length 6-1/2in (16.5cm).

**SU2775-MM**

Curved. Mueller-Mirror® finish. Overall length 6-1/2in (16.5cm).

**SU2777**

Curved. Overall length 8in (20.3cm).

**SU2780**

Curved. Overall length 12in (30.5cm).

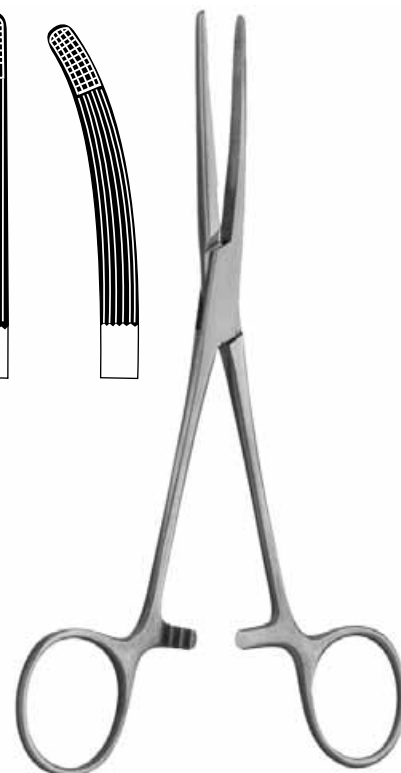
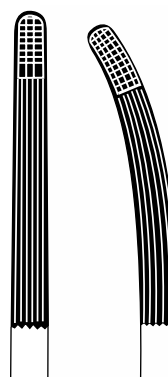

◆ Most widely used patterns

## Hemostats

Pinces hémostatiques  
Gefäßklemmen (Hämostat)  
Pinze emostatische  
Hemostatos  
Pinças hemostáticas  
止血剂

### BEEBE Hemostatic Forceps

Narrow jaws. 1 x 2 teeth.  
Longitudinal serrations.

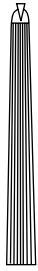

#### SU2830

Overall length  
6-1/4in (15.9cm).

#### SU2832

Overall length  
8in (20.3cm).



### KOCHER Artery Forceps

1 x 2 teeth. Overall length 5-1/2in (14cm).

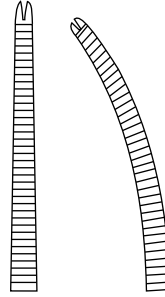

#### SU2790

Straight.

#### SU2790-MM

Straight.  
Mueller-Mirror® finish.

#### SU2792

Curved.

#### SU2792-MM

Curved.  
Mueller-Mirror® finish.



### OCHSNER-DIXON Artery Forceps

Straight.  
Light pattern.  
Narrow jaws.  
1 x 2 teeth.



#### SU2820

Overall length  
6-1/4in (15.9cm).

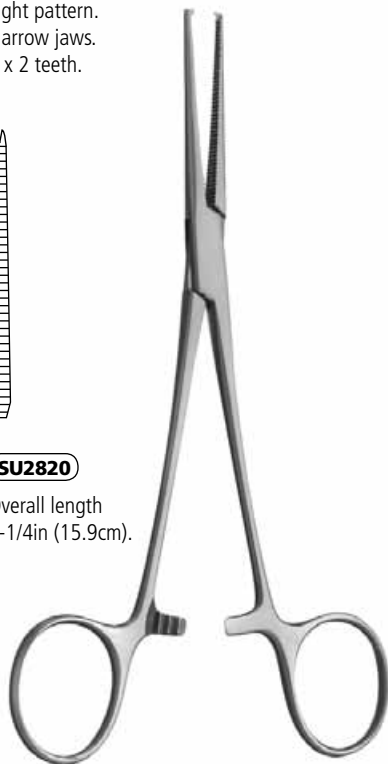

### OCHSNER Artery Forceps

1 x 2 teeth.

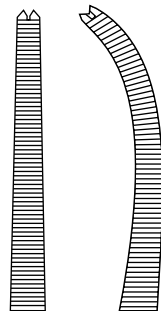

#### ◆ SU2800

Straight.  
Overall length  
6-1/4in (15.9cm).

#### SU2800-MM

Mueller-Mirror® finish.

#### ◆ SU2802

Straight.  
Overall length  
7-1/4in (18.4cm).

#### SU2802-MM

Mueller-Mirror® finish.

#### ◆ SU2804

Straight.  
Overall length  
8in (20.3cm).

#### SU2804-MM

Mueller-Mirror® finish.

#### SU2810

Curved.

#### SU2810-MM

Mueller-Mirror® finish.

#### SU2812

Curved.  
Overall length  
7-1/4in (18.4cm).

#### SU2814

Curved.  
Overall length  
8in (20.3cm).

#### SU2814-MM

Mueller-Mirror® finish.



**ROCHESTER-OCHSNER Artery Forceps**

Extra-long. 1 x 2 teeth.

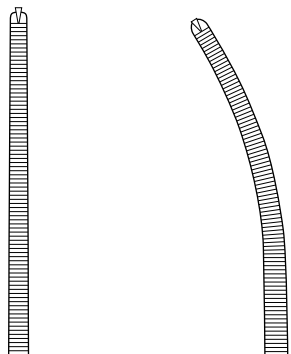

**SU2806**

Straight.  
Overall length  
10in (25.4cm).

**SU2808**

Straight.  
Overall length  
14in (35.6cm).

**SU2816**

Curved.  
Overall length  
10in (25.4cm).

**SU2818**

Curved.  
Overall length  
14in (35.6cm).



**KOCHER Forceps**

Straight. 1 x 2 teeth.  
Double-action box locks.

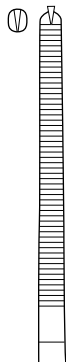

**SU2797**

Overall length  
18in (45.7cm).



**BALLENGER Sponge Holding Forceps**

Straight. Overall length 7in (17.8cm).

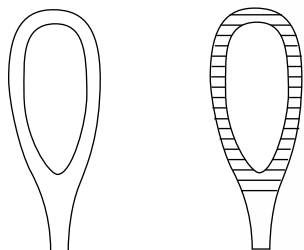

**MO1750**

Smooth loop jaws.

◆ **MO1760**

Serrated loop jaws.

**MO1760-MM**

Mueller-Mirror® finish.



**BALLENGER Sponge Holding Forceps**

Curved. Overall length 7in (17.8cm).

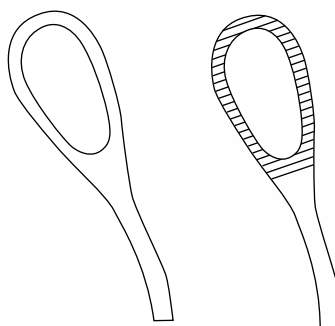

**MO1770**

Smooth loop jaws.

**MO1780**

Serrated loop jaws.

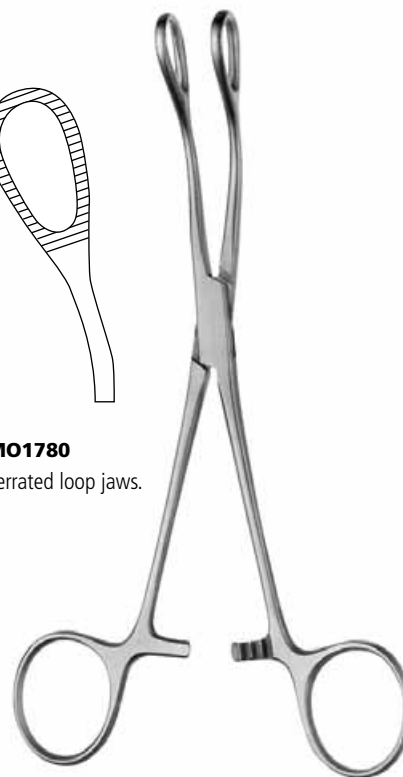

## Clamps

Clamps  
Klemmen  
Morse  
Pinzas  
Pinças  
クランプ

### FOERSTER Sponge Forceps

Straight.

◆ **GL650**

Serrated.  
Overall length  
9-3/4in (24.8cm).

**GL650-MM**

Mueller-Mirror® finish.

**GL651**

Smooth.  
Overall length  
9-3/4in (24.8cm).

**GL651-MM**

Mueller-Mirror® finish.

◆ **GL652**

Serrated.  
Overall length  
12in (30.5cm).

**GL654**

Serrated.  
Overall length  
14in (35.6cm).

**GL656**

Serrated.  
Overall length  
16in (40.6cm).

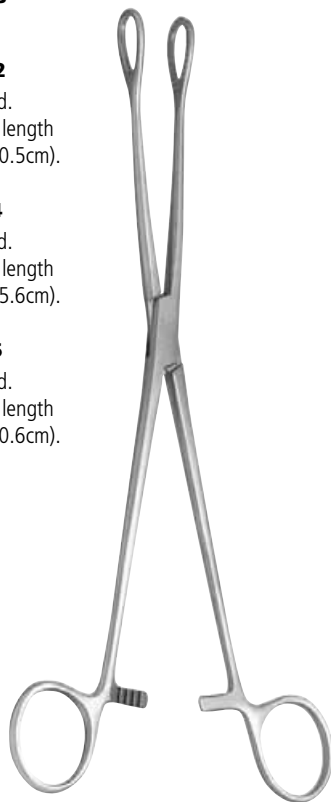

### FOERSTER Sponge Forceps

Curved.

○ **GL660**

Serrated.  
Overall length  
9-5/8in (24.4cm).

**GL660-MM**

Serrated.  
Mueller-Mirror® finish.

**GL661**

Smooth.  
Overall length  
9-5/8in (24.4cm).

**GL662**

Serrated.  
Overall length  
12in (30.5cm).



### BACKHAUS Towel Forceps

◆ **SU2900**

Overall length  
3-1/2in (8.9cm).

**SU2900-MM**

Mueller-Mirror® finish.

◆ **SU2905**

Overall length  
5-1/4in (13.3cm).

**SU2905-MM**

Mueller-Mirror® finish.



### ROEDER Towel Forceps

Ball stops.

○ **SU2910**

Overall length  
5-1/2in (14cm).

**SU2910-MM**

Mueller-Mirror® finish.



**JONES Towel Forceps**

Cross-action.

**SU2920**Overall length  
3-3/8in (8.5cm).**MOYNIHAN Towel Forceps**

2 x 2 prongs.

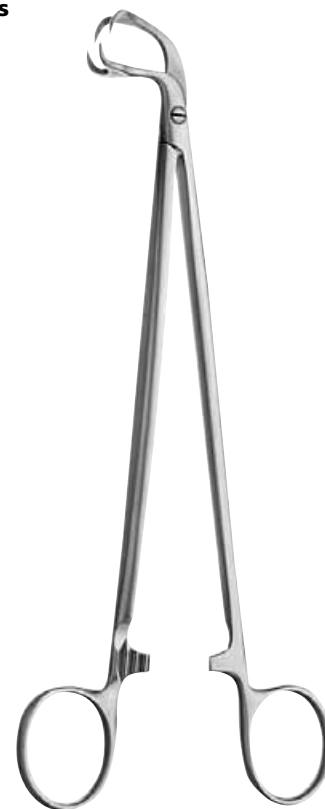
**SU2930**Overall length  
7-1/2in (19.1cm).**V. Mueller® Non-Perforating Towel Forceps**◆ **SU2935**Overall length  
4in (10.2cm).**SU2935-MM**

Mueller-Mirror® finish.

◆ **SU2936**Overall length  
5-1/4in (13.3cm).**SU2936-MM**

Mueller-Mirror® finish.

**LORNA Non-Perforating Towel Forceps**

Edna-style.

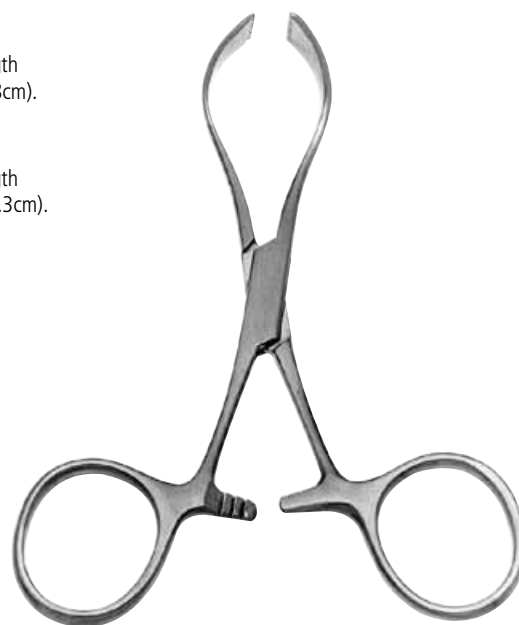
◆ **SU2937**Overall length  
3-7/8in (9.8cm).◆ **SU2938**Overall length  
5-1/4in (13.3cm).

## Clamps

Clamps  
Klemmen  
Morse  
Pinzas  
Pinças  
クランプ

### Tubing Clamp Forceps

Heavier, with deep serrations designed to clamp off tubing safely and efficiently. Straight.



**SU2850**

Overall length  
6-1/2in (16.8cm).



### Tubing Clamp Forceps

**SU2852**

Tubing max O.D. 3/8in (9.5mm) with wall 1/32in (0.79mm) to 1/16in (1.59mm). Overall length 6in (15.2cm).

◆ **SU2854**

Tubing max O.D. 5/8in (16mm) with wall 1/16in (1.59mm) to 3/32in (2.4mm). Overall length 7-1/2in (19.1cm).

◆ **SU2856**

Tubing max O.D. 7/8in (22mm) with wall 3/32in (2.4mm) to 1/8in (3mm). Overall length 8in (20.3cm).



### Tubing Clamp Forceps

With guard.

**SU2853**

For 3/8in (1cm) tubing.  
Overall length  
6in (15.2cm).

**SU2855**

For 5/8in (1.6cm) tubing.  
Overall length  
7-1/4in (18.4cm).

**SU2857**

For 7/8in (2.2cm) tubing.  
Overall length  
8in (20.3cm).



### V. Mueller Brand Vital Instruments

V. Mueller brand Vital instruments feature either Stellite® edges or tungsten carbide jaw inserts. Handled properly, these materials have wear resistance and durability far above that of high carbon or stainless steel.



**ALLIS Micro-Line® Tissue Forceps**

Light, delicate.

◆ **SU4048**4 x 5 teeth.  
Overall length  
5-3/4in (14.6cm).**SU4047**3 X 4 teeth.  
Overall length  
5in (12.7cm).**ALLIS-OCHSNER Tissue Forceps**

3 x 4 fine teeth. Jaw 4mm wide.

**SU4050**Overall length  
5-1/2in (14cm).**BOYS-ALLIS Tissue Holding Forceps**

Heavy pattern, 5 x 6 teeth.

**SU4060**Overall length  
6in (15.2cm).**ALLIS Tissue Forceps**◆ **SU4054**4 x 5 teeth.  
Overall length  
6in (15.2cm).**SU4054-MM**

Mueller-Mirror® finish.

◆ **SU4055**5 x 6 teeth.  
Overall length  
6in (15.2cm).**SU4055-MM**

Mueller-Mirror® finish.

◆ **SU4056**Light pattern,  
5 x 6 teeth.  
Overall length  
7-1/2in (19.1cm).**SU4056-MM**

Mueller-Mirror® finish.

**SU4057**Heavy pattern.  
5 x 6 teeth.  
Overall length  
7-1/2in (19.1cm).**SU4057-MM**

Mueller-Mirror® finish.

◆ **CH1560**5 x 6 teeth.  
Overall length  
10in (25.4cm).**CH1560-MM**

Mueller-Mirror® finish.

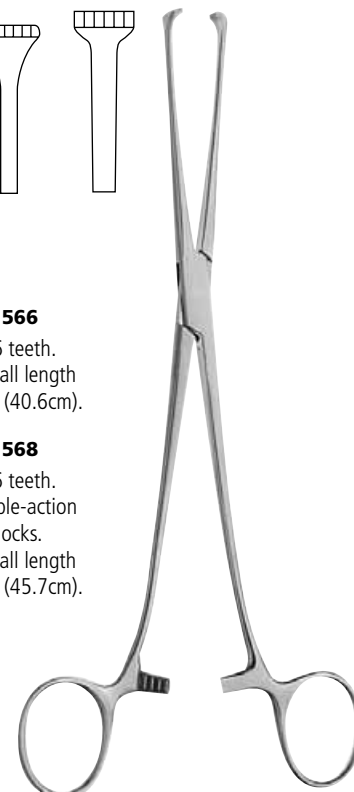
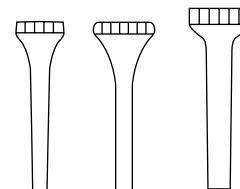
◆ **CH1562**5 x 6 teeth.  
Overall length  
12in (30.5cm).**CH1564**5 x 6 teeth.  
Overall length  
14in (35.6cm).

## Clamps

Clamps  
Klemmen  
Morse  
Pinzas  
Pinças  
クランプ

### THOMS Tissue Forceps

6 x 7 teeth.

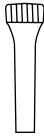

**SU4070**

Overall length  
8in (20.3cm).

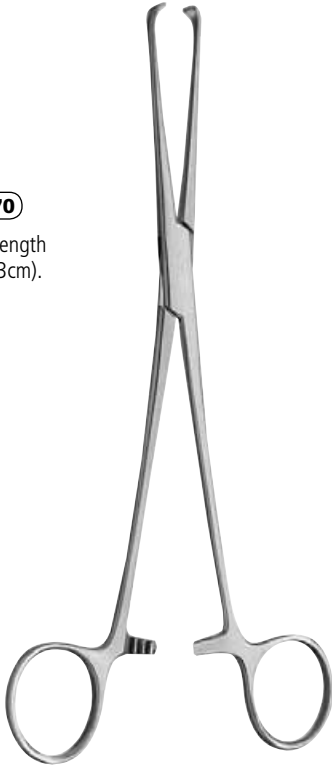

### LOCKWOOD Intestinal Forceps

Short.



**SU4090**

Overall length  
6-1/2in (16.5cm).



### JUDD-ALLIS Intestinal Tissue Forceps



**SU4080**

Overall length  
7-1/2in (19.1cm).



### GLASSMAN-BABCOCK Forceps

Jaw 1cm, rounded corners.



**SU5005**

Overall length  
6-1/2in (16.5cm).



### BABCOCK Petite Point Tissue Forceps

**SU5012**

Jaws 6mm wide.  
Overall length  
5-1/4in (13.3cm).

**SU5012-001**

Extra delicate.  
Jaws 6mm wide.  
Overall length  
5-1/2in (14cm).

**SU5014**

Jaws 7.5mm wide.  
Overall length  
6-1/4in (15.9cm).

**SU5014-001**

Extra delicate.  
Jaws 7.5mm wide.  
Overall length  
6-1/4in (15.9cm).

**SU5018**

Jaws 7.5mm wide.  
Overall length  
8in (20.3cm).

**SU5019**

Jaws 7.5mm wide.  
Overall length  
9-1/2in (24.2cm).



**BABCOCK Tissue Holding Forceps**◆ **SU5000**

Overall length  
6-1/4in (15.9cm).

**SU5000-MM**

Mueller-Mirror® finish.

◆ **SU5001**

Jaws 10.4mm wide.  
Overall length  
8in (20.3cm).

**SU5001-MM**

Mueller-Mirror® finish.

**CH1571**

Jaws 9.5mm wide.  
Overall length  
9-1/2in (24.1cm).

**CH1570**

Jaws 16mm wide.  
Overall length  
9-1/2in (24.1cm).

◆ **SU5003**

Overall length  
12in (30.5cm).

**SU5004**

Overall length  
14in (35.6cm).

**SU5004-001**

Overall length  
16in (40.6cm).

**SU5002**

Delicate jaws.  
Overall length  
7-1/2in (19.1cm).

**BABCOCK Tissue Holding Forceps****SU5006**

Double-action  
box locks.  
Overall length  
18in (45.7cm).

**Vital® BABCOCK Forceps**

Tungsten Carbide inserts.  
2,500 teeth per square inch.

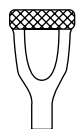
**SU5010**

Overall length  
6-1/2in (16.5cm).

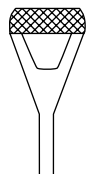
**SU5011**

Overall length  
8-1/4in (20.9cm).

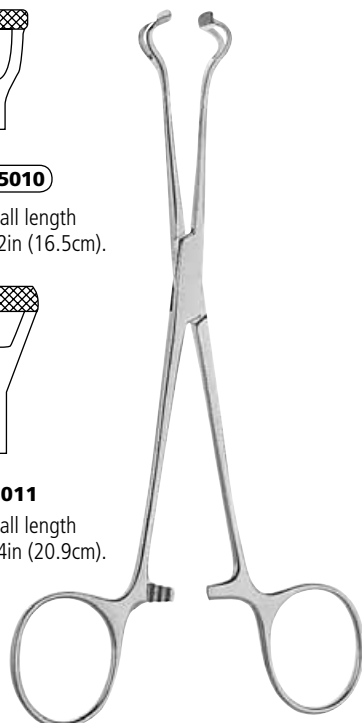
**TURNER-BABCOCK Tissue Forceps**

With solid jaws and  
atraumatic transverse  
grooves for additional  
holding power.

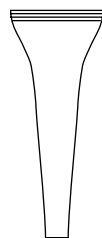
**SU5007**

Overall length  
9-1/2in (24.1cm).

**COLLINS (DUVAL-CRILE) Forceps**

Screw lock.

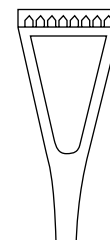
**SU5015**

Jaws 1/2in  
(13mm).  
Overall length  
8in (20.3cm).

**SU5013**

Jaws 3/4in  
(20mm).  
Overall length  
9in (22.9cm).

**SU5016**

Jaws 1in  
(25mm).  
Overall length  
8in (20.3cm).

**SU5012**

Jaws 1-1/8in  
(30mm).  
Overall length  
7-1/2in (19cm).

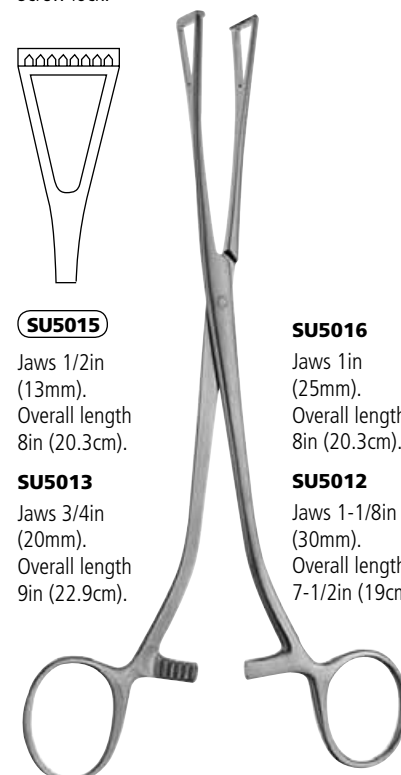

## Clamps

Clamps  
Klemmen  
Morse  
Pinzas  
Pinças  
クランプ

### Vital® DUVAL Intestinal Forceps

Serrated. Tungsten Carbide inserts.

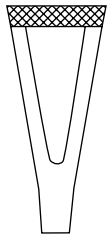

**SU5017**

Overall length  
8in (20.4cm).



### PERCY Intestinal Forceps

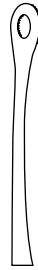

**SU5025**

Overall length  
6in (15.2cm).



### WILLIAMS Intestinal Forceps



**SU5030**

Overall length  
6-1/2in (16.5cm).



### LILLIE Intestinal Tissue Forceps



**SU5040**

Overall length  
8in (20.3cm).



**BAINBRIDGE Intestinal Forceps**

Longitudinal serrations.

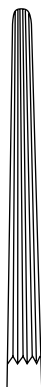

**SU6000**

Straight.  
Overall length  
6in (15.2cm).

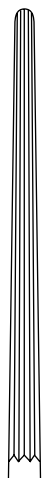

**SU6001**

Straight.  
Overall length  
7-1/4in (18.4cm).

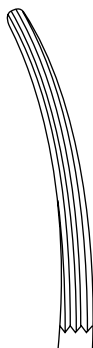

**SU6005**

Curved.  
Overall length  
6in (15.2cm).

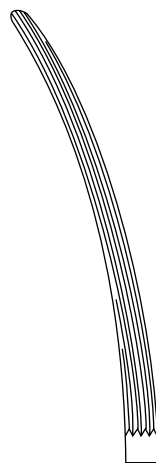

**SU6006**

Curved.  
Overall length  
7-1/4in (18.4cm).



**ALLEN Micro-Line® Intestinal Forceps**

Straight, delicate. Jaws longitudinally serrated,  
1 x 2 teeth.



**SU6029**

Overall length  
6in (15.2cm).

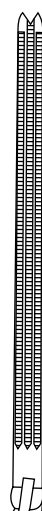

**SU6030**

Overall length  
8in (20.3cm).

**ALLEN Intestinal Clamp**

Longitudinal serrations. 1 x 2 teeth.



**Clamps**

Clamps  
Klemmen  
Morse  
Pinzas  
Pinças  
クランプ

**DENNIS Anastomosis Clamp**

Longitudinal serrations.  
Short jaw, length 2-1/4in (5.7cm).

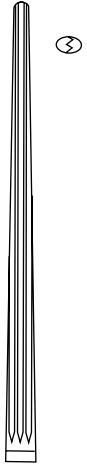

**SU6020**

Overall length  
9-1/4in (23.5cm).



**KOCHER Micro-Line® Intestinal Forceps**

Longitudinal serrations. Overall length 5-1/2in (14cm).

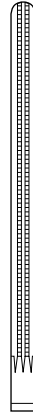

**SU6049**

Straight jaws.

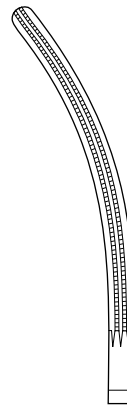

**SU6054**

Curved jaws.

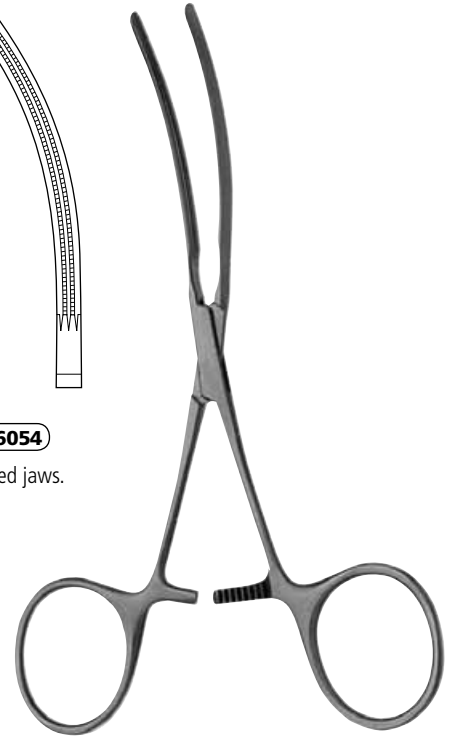

**KOCHER Intestinal Forceps**

Longitudinal serrations. Light.

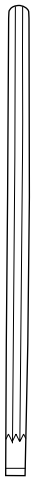

**SU6050**

Straight.  
Overall length  
9-7/8in (25.1cm).

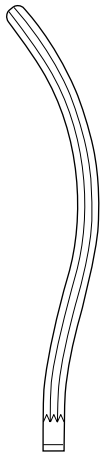

**SU6055**

Curved.  
Overall length  
9-3/4in (24.8cm).



**MAYO-ROBSON Intestinal Forceps**

Longitudinal serrations.  
Overall length  
10in (25.4cm).



**SU6065**

Straight.

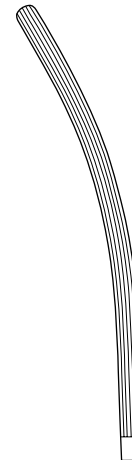

**SU6066**

Curved.



**DOYEN Intestinal Forceps**

Diagonal serrations.  
Overall length  
8-3/4in (22.2cm).

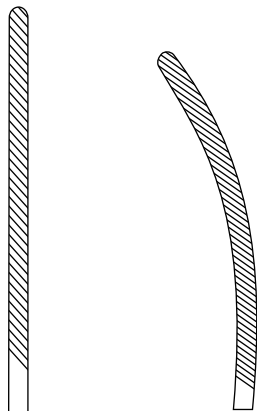

**SU6080**  
Straight.

**SU6082**  
Curved,  
flexible jaws.



**GLASSMAN Non-Crushing Gastrointestinal Clamps**

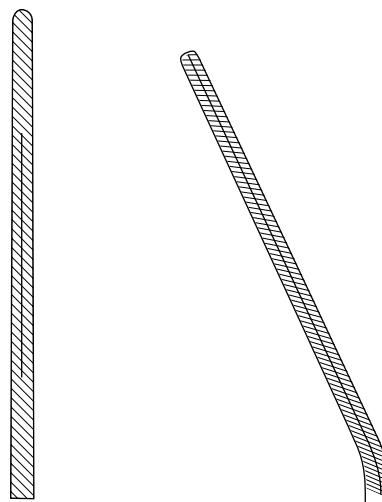

◆ **SU6100**  
Straight.  
Overall length  
9-1/4in (23.5cm).

◆ **SU6110**  
Angled.  
Overall length  
9in (22.9cm).

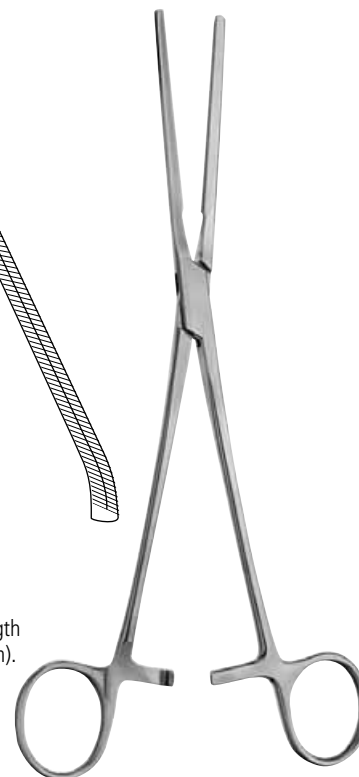

**GLASSMAN Anterior Resection Clamps**

Jaws right-angled. Fully serrated.

**SU6128**  
Jaw length 1in (2.5cm).  
Overall length  
9-3/4in (24.8cm).

**SU6129**  
Jaw length 2in (5.1cm).  
Overall length  
9-3/4in (24.8cm).

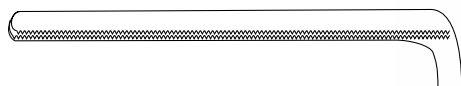

◆ **SU6130**  
Jaw length 3in (7.6cm).  
Overall length  
10in (25cm).

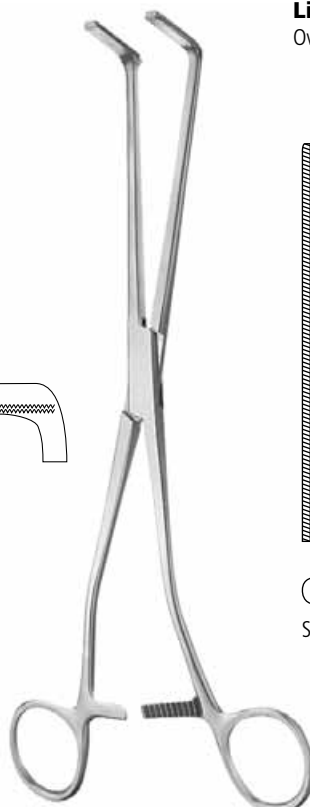

**GLASSMAN Non-Crushing Intestinal and Liver-Holding Clamps**

Overall length 9-3/4in (24.8cm).

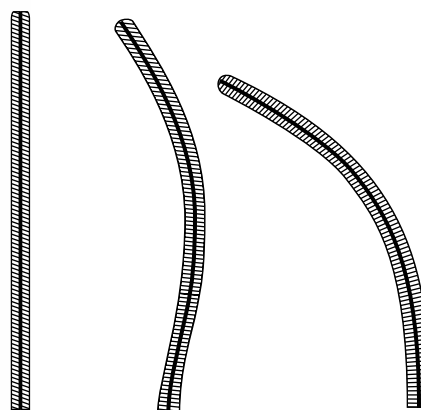

**SU6132**  
Straight.

**SU6135**  
Curved.

**SU6136**  
Fully curved.

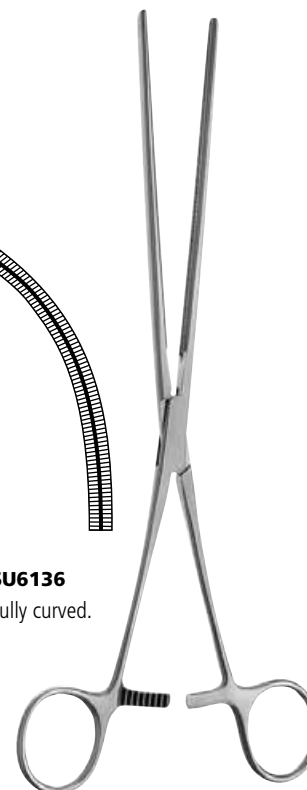

**Clamps**

Clamps  
Klemmen  
Morse  
Pinzas  
Pinças  
クランプ

**GLASSMAN Non-Crushing Gastroenterostomy Clamp**

Straight. Jaw length 4-9/16in (11.6cm).



**SU6156**

Overall length  
11-1/2in (29.2cm).



**GLASSMAN Non-Crushing Gastroenterostomy Clamp**

Angled. Jaw length 4-1/2in (11.4cm).

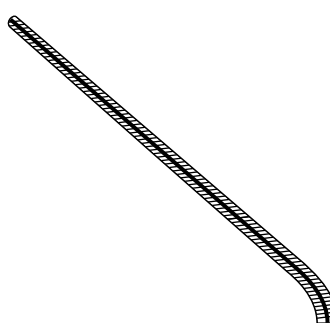

**SU6158**

Overall length  
10-1/8in (25.7cm).



**CARTER-GLASSMAN Resection Clamps**

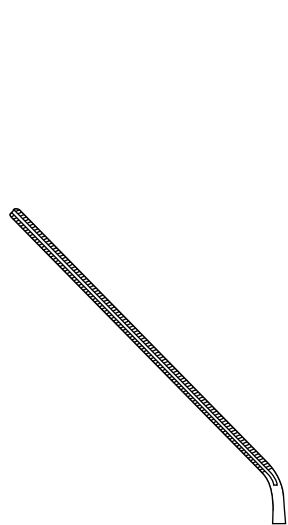

**SU6162**

Angled 45°.  
Jaw length  
4in (10.2cm).  
Overall length  
10in (25.4cm).

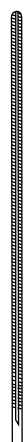

**SU6160**

Straight.  
Jaw length  
4in (10.2cm).  
Overall length  
11-1/4in (28.5cm).



*Looking for a specific product?*

When you know the catalog number or the name of the product you need, you can use the index at the end of this book to direct you to the page on which the product is described. If you do not find the specific instruments you are looking for, please contact your local V. Mueller sales representative or Customer Support at **800.323.9088**.

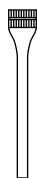

**GLASSMAN-ALLIS Non-Crushing Intestinal Forceps****SU6151**

Delicate.  
Overall length  
6in (15.2cm).

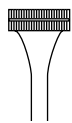
**SU6152**

Overall length  
7-1/2in (19.1cm).

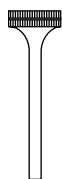
**SU6150**

Overall length  
6in (15.2cm).

**GLASSMAN-ALLIS Non-Crushing Common Duct Forceps****SU6154**

Overall length  
8-1/2in (21.6cm).

**V. Mueller Instrument Warranty**

We warranty every medical device and accessory bearing the V. Mueller brand name to be free of functional defects in workmanship and materials when used normally for its intended use. Any V. Mueller product proving to be so defective will be replaced or repaired at no charge. Repairs or modifications performed by unauthorized personnel may void all product warranties and could affect performance and efficacy of the device.

**FEHLAND Right Angled Colon Clamp**

Horizontal serrations.  
Jaw length 3-1/4in (8.3cm)  
at right angle.

**SU7040**

Overall length  
10in (25.4cm).



## Clamps

Clamps  
Klemmen  
Morse  
Pinzas  
Pinças  
クランプ

### DIXON-THOMAS-SMITH Colon Clamp

Fully curved. Smooth jaws, angled shanks.

**SU7020**

Overall length  
10-1/2in (26.7cm).



### FOSS Anterior Resection Clamp

Curved blades, curved shanks.

**SU7030**

Overall length  
10-3/4in (27.5cm).



### PEMBERTON Sigmoid Anastomosis Clamp

Angled jaws with heavy longitudinal ridge.



**SU7090**

Overall length  
9-1/2in (24.1cm).



### BEST Right-Angle Colon Clamps

Overall length 11in (27.9cm).

**SU7060**

Set of four.  
Includes one each of  
SU7061 and SU7062  
and two each of SU7063.

**SU7061**

Jaw length  
3in (7.6cm).

**SU7062**

Jaw length  
2-3/8in (6cm).

**SU7063**

Jaw length  
1-3/8in (3.5cm).



**STONE Intestinal Clamp Set****SU8010**

Set includes two each of SU8010-001, SU8011 and SU8012.

**SU8011**

STONE Clamp. Overall length 3-3/8in (8.5cm).

**SU8012**

WATTS Locking Clamp for SU8010.

**DeMARTEL-WOLFSON Colon Clamps**

Set of three.

**SU10082**

Overall length 2-7/8in (7.4cm).

**SU10080**

Overall length 3-1/2in (8.8cm).

**SU10081**

Overall length 4-5/8in (11.8cm).

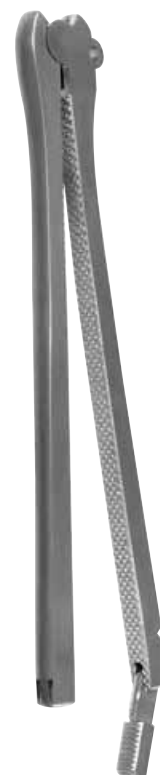
**DeMARTEL-WOLFSON Clamp Holders****SU10084**

Long. Overall length 9in (22.9cm).

**DeMARTEL-WOLFSON Closing Forceps****SU10085**

Overall length 9-3/4in (24.9cm).



## Clamps

Clamps  
Klemmen  
Morse  
Pinzas  
Pinças  
クランプ

### RAVITCH Pyloric Stenosis Spreader

Blades open as handles are closed to a maximal spread.  
Each blade has a small lip to reduce slippage.

**SU8085**

Overall length  
5-3/4in (14.6cm).



### PAYR Resection Clamps

With pin.

**SU9070**

Overall length  
8in (20.3cm).

**SU9072**

Overall length  
11-1/4in (28.6cm).

**SU9074**

Overall length  
13-3/8in (34cm).



### KOCHER Bronchocele Sound

With eye.

**SU3940**

Overall length  
6-3/4in (17.1cm).



### LAHEY Goiter Vulsellum Forceps

Straight. 3 x 3 teeth.

◆ **SU3960**

Overall length  
6in (15.2cm).



### MASTIN Muscle Clamp

Curved shanks.

**SU3970**

Overall length  
6-1/2in (16.5cm).



**LAHEY Ligature Carrier**

Curved right.

**SU3980**

Overall length  
7-1/2in (19cm).



**DESCHAMPS Ligature Carriers**

Sharp. Overall length 8in (20.3cm).

**SU3990**

Right.

**SU3991**

Left.



**DESCHAMPS Ligature Carriers**

Blunt. Overall length 8in (20.3cm).

**SU3992**

Right.

**SU3993**

Left.



**MIXTER Gall Duct Forceps**

Fully curved.

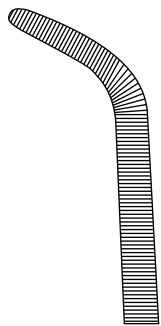

**SU10500**

Overall length  
6-1/4in (15.9cm).

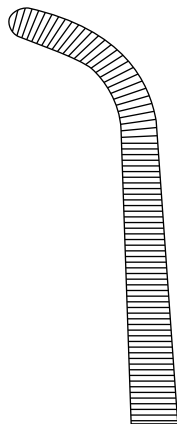

**SU10501**

Overall length  
7-3/4in (19.7cm).

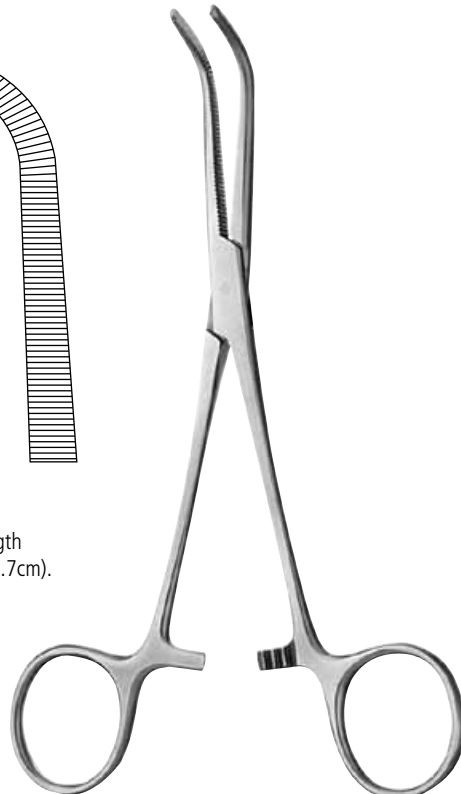

**ROCHESTER-MIXTER Gall Duct Forceps**

Fully curved. Delicate.

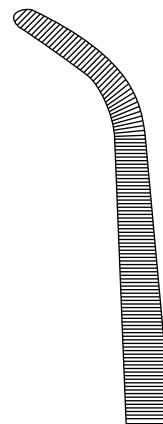

**SU10502**

Overall length  
7-3/4in (19.7cm).

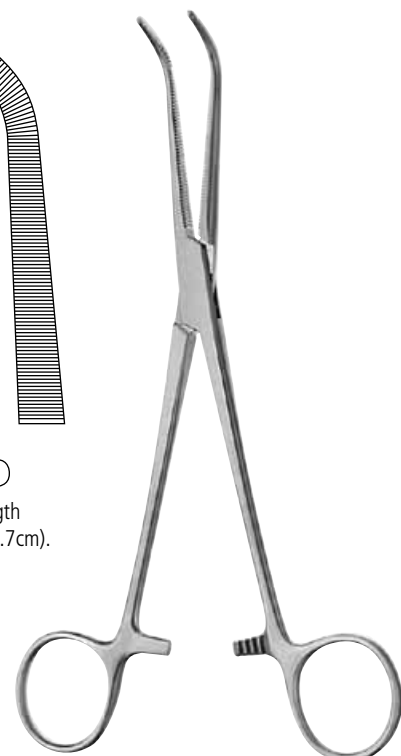

**Forceps/Clamps**

Forceps/Clamps  
Zangen/Klemmen  
Pinze/Morse  
Fórceps/Pinças  
Fórceps/Pinças  
鉗子/クランプ

**MIXTER Micro-Line® Pediatric Forceps**

Fine and delicate.

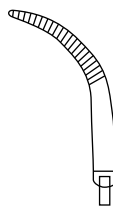

**SU10495**  
Fully curved jaws.  
Overall length  
5-1/4in (13.3cm).

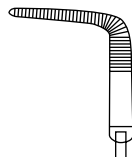

◆ **SU10496**  
Right-angled jaws.  
Overall length  
5in (12.8cm).

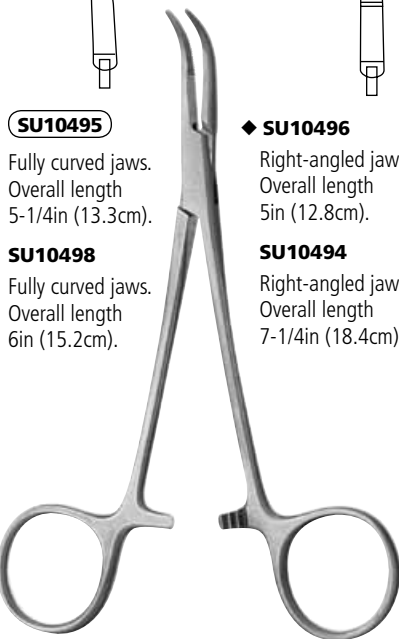

**SU10498**  
Fully curved jaws.  
Overall length  
6in (15.2cm).

**SU10494**  
Right-angled jaws.  
Overall length  
7-1/4in (18.4cm).

**THOREK-MIXTER Gall Duct Forceps**

Fully curved.

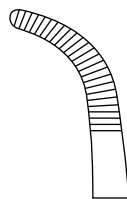

**SU10505**  
Overall length  
5-1/2in (14cm).



**MEEKER Artery Forceps**

Right-angled jaws.

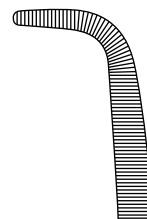

**SU10560**  
Overall length  
7in (17.8cm).

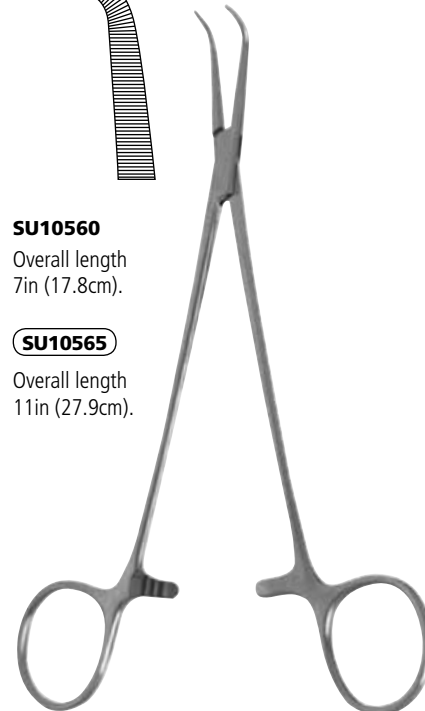

**SU10565**  
Overall length  
11in (27.9cm).

**GEMINI Artery Forceps**

Fine "J" curve.

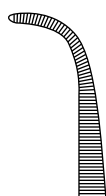

**SU10530**  
Overall length  
5-1/2in (14cm).

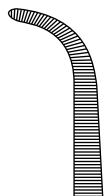

**SU10531**  
Overall length  
7in (17.8cm).

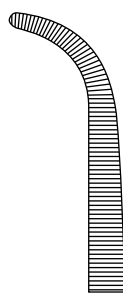

**SU10532**  
Overall length  
8in (20.3cm).

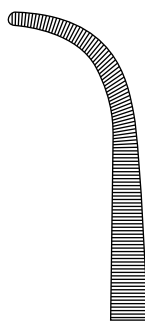

**SU10533**  
Overall length  
9in (22.9cm).



**SU10534**  
Overall length  
11-1/8in (28.3cm).



**JUDD-DeMARTEL Gall Bladder Forceps**

Round jaws are fenestrated and serrated. Screw lock.

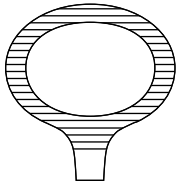

**SU10750-1**

Overall length  
6-1/4in (15.9cm).



**LAHEY Gall Duct Forceps**

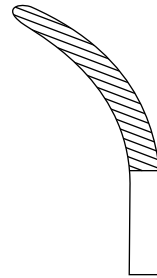

**SU10520**

Angled serrations. Overall length  
7-1/2in (19.1cm).



**LAHEY Gall Duct Forceps**

Right-angled, longitudinal serrations with cross-serrated tips.

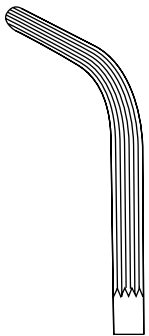

**SU10524**

Longitudinal  
serrations.  
Overall length  
7-3/4in (19.7cm).

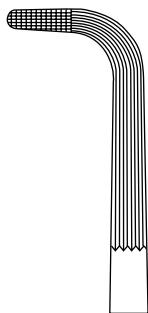

**SU10525**

Right angle,  
longitudinal  
serrations with  
cross-serrated tips.  
Overall length  
7-1/2in (19.1cm).

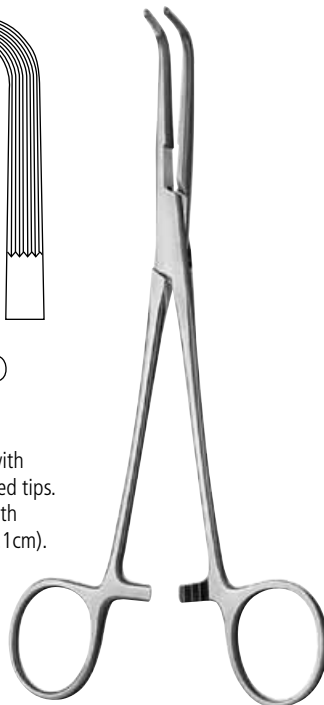

**Right-Angled Forceps**

Double-action box locks.

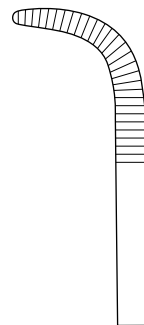

**SU7050**

Overall length  
18in (45.7cm).



**Forceps/Clamps**

Forceps/Clamps  
Zangen/Klemmen  
Pinze/Morse  
Fórceps/Pinças  
Fórceps/Pinças  
鉗子/クランプ

**WESTPHAL Gall Duct Forceps**

Curved. Delicate, longitudinal serrations.

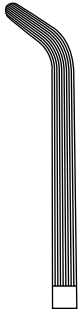

**SU10526**

Overall length  
7-3/4in (19.7cm).



**ELLIOTT Gall Bladder Forceps**

Fully curved.

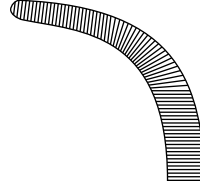

**SU10550**

Overall length  
8in (20.3cm).



**BEVAN Gall Bladder Forceps**

Fully curved.

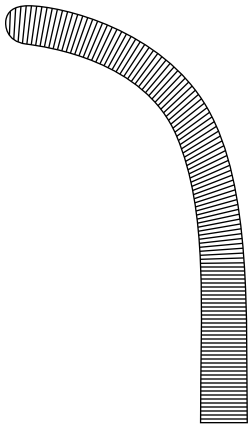

**SU10596**

Overall length  
8-1/4in (21cm).



**SHALLCROSS Cystic Duct Forceps**

Fully curved.

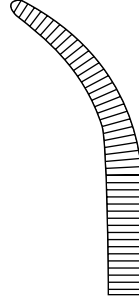

**SU10510**

Overall length  
8in (20.3cm).





**GRAY Cystic Duct Forceps**

Set of two. Without teeth. Curved.

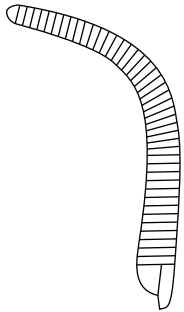

**SU10592**

Overall length  
9in (22.9cm).



**SWENSON Ring-Jawed Holding Clamp**

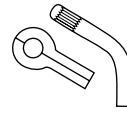

**SU10570**

Overall length  
6-1/4in (15.9cm).



**TAUFIC Clamp**

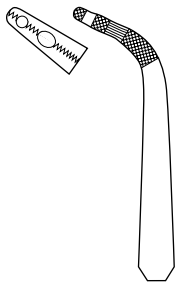

**SU10574**

Overall length  
8-1/2in (21.6cm).



**BEST Common Duct Stone Forceps**

Fenestrated jaws are both cupped and serrated.



**SU10710**

Overall length  
9in (23cm).

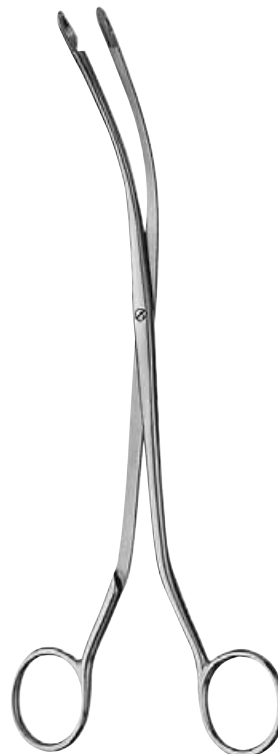

**ROCHESTER Gall Stone Forceps**

Slight curve, fenestrated jaw, cupped. Screw lock.



**SU10700**

Overall length  
9in (23cm).



**Probes/Dilators**

Sondes/Dilatateurs  
Sonden/Dilatatoren  
Sonde/Dilatatori  
Sondas/Dilatadores  
Sondas/Dilatadores  
プローブ/拡張器

**Probes**

Triangular tip.

**SU10800450**

Overall length  
4-1/2in (11.4cm).

**SU10800600**

Overall length  
6in (15.2cm).

**SU10800800**

Overall length  
8in (20.3cm).

**Probes With Eye**

Silver Plated.

**SU10810450**

Overall length  
4-1/2in (11.4cm).

**SU10810500**

Overall length  
5in (12.7cm).

**SU10810550**

Overall length  
5-1/2in (14cm).

**SU10810600**

Overall length  
6in (15.2cm).

**SU10810800**

Overall length  
8in (20.3cm).

**SU10810010**

Overall length  
10in (25.4cm).

**SU10810120**

Overall length  
12in (30.5cm).

**Probes with Eye**

Silver.

**SU10811500**

Overall length  
5in (12.7cm).

**SU10811550**

Overall length  
5-1/2in (14cm).

**SU10811600**

Overall length  
6in (15.2cm).

**SU10811800**

Overall length  
8in (20.3cm).

**Grooved Directors with Tongue Tie**

Mirror finish.

**SU10820450**

Overall length  
4-1/2in (11.4cm).

**SU10820500**

Overall length  
5in (12.7cm).

**SU10820550**

Overall length  
5-1/2in (14cm).

**SU10820600**

Overall length  
6in (15.2cm).

**Grooved Directors With Probe End and Tongue Tie**

Mirror finish.

**SU10830500**

Overall length  
5in (12.7cm).

**SU10830550**

Overall length  
5-1/2in (14cm).

**SU10830600**

Overall length  
6in (15.2cm).

**BAKES Common Bile Duct Dilators**

Mirror finish. Overall length 9in (22.9cm).

**SU10920**

Set includes  
9 dilators.

**SU10921003**

3mm.

**SU10921004**

4mm.

**SU10921005**

5mm.

**SU10921006**

6mm.

**SU10921007**

7mm.

**SU10921008**

8mm.

**SU10921009**

9mm.

**SU10921010**

10mm.

**SU10921011**

11mm.

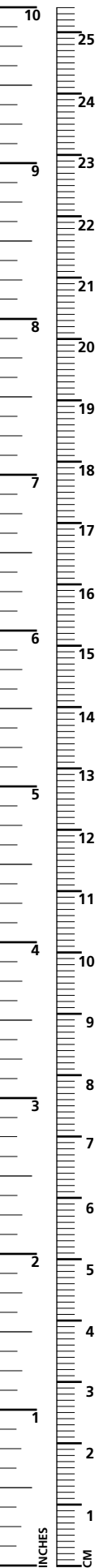

Sondes/Dilatateurs  
 Sonden/Dilatatoren  
 Sonde/Dilatatori  
 Sondas/Dilatadores  
 Sondas/Dilatadores  
 プローブ/拡張器

**DESJARDIN Gall Stone Probes**

Malleable. Mirror and Satin finish.  
 Overall length 10-7/8in (27.6cm).

**SU10900015**

15Fr.

**SU10900018**

18Fr.

**SU10900020**

20Fr.



**MAYO Common Duct Probes**

Malleable. Silver Plated. Overall length  
 9-7/8in (25.1cm).

**SU10910015**

15Fr.

**SU10910018**

18Fr.

**SU10910020**

20Fr.



**BERENS Common Duct Scoops**

Silver Plated. Overall length  
 9in (22.9cm).



**SU10982001**

No. 1, small.



**SU10982010**

No. 2, large.



**MAYO-ROBSON Gall Stone Scoop**

Silver Plated.

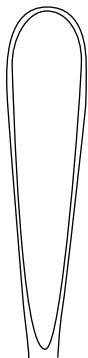

**SU11000**

Overall length  
 10-1/2in (26.7cm).



**MAYO Gall Stone Scoop**

Double-ended.

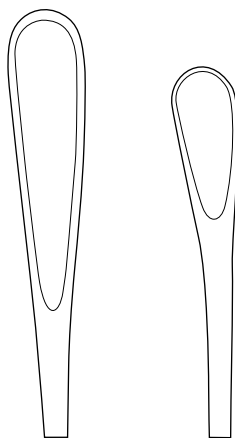

**SU11010**

Overall length  
 10-3/4in (27.3cm).



**MAYO Common Duct Scoops**

Malleable. Silver Plated. Overall length  
 11in (27.9cm).



**SU10980001**

No. 1, small.

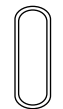

**SU10980006**

No. 2, medium.



**SU10980010**

No. 3, large.



**Probes/Dilators**

Sondes/Dilatateurs  
 Sonden/Dilatatoren  
 Sonde/Dilatatori  
 Sondas/Dilatadores  
 Sondas/Dilatadores  
 プローブ/拡張器

**MAYO Cystic Duct Scoop**

Malleable. Silver Plated.

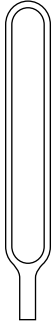

**SU10990**

Overall length  
 12in (30.5cm).



**FERGUSON Gall Stone Scoops**

Double-ended. Overall length 9in (22.9cm).

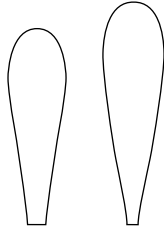

**SU1102001**

Size 1. Extra-small/small.

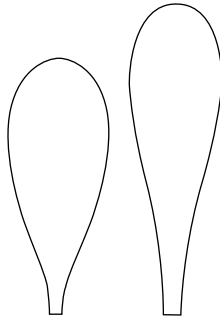

**SU1102002**

Size 2. Medium/large.

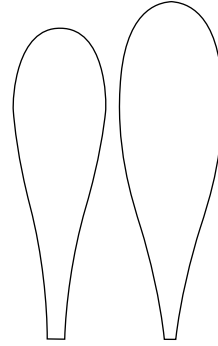

**SU1102003**

Size 3. Large/extra-large.



**DESJARDIN Gall Stone Scoops**

Overall length 11in (27.9cm).



**SU11030017**

Size 1, 17Fr.



**SU11030021**

Size 2, 21Fr.



**SU11030024**

Size 3, 24Fr.



**SU11030027**

Size 4, 27Fr.

**MOORE Gall Bladder Spoon**

**SU11050**

Overall length  
 11in (27.9cm).



Sondes/Dilatateurs  
Sonden/Dilatatoren  
Sonde/Dilatatori  
Sondas/Dilatadores  
Sondas/Dilatadores  
プローブ/拡張器

**ROCHESTER Syringe**

Curved, malleable.  
Probe tip. Luer lock connector.  
Partially Chrome Plated.

**SU11040**

Working length  
5-7/8in (14.9cm).



**OCHSNER Trocars**

Mirror finish.  
Overall length  
5-3/4in (14.5cm).

**SU11300014**

14Fr. for 10Fr. catheter.

**SU11300018**

18Fr. for 12Fr. catheter.

**SU11300020**

20Fr. for 14Fr. catheter.

**SU11300022**

22Fr. for 16Fr. catheter.

**SU11300024**

24Fr. for 18Fr. catheter.

**SU11300027**

27Fr. for 20Fr. catheter.



**DUKE Trocars and Cannulas**

With perforated tube for  
fluid withdrawal.  
Mirror finish.

**SU11310**

Overall length  
4-5/8in (11.7cm).

**SU11311**

Overall length  
6in (15.2cm).



**SENN Retractors**

Delicate, double-ended.  
Overall length  
6-1/4in (15.9cm).

◆ **SU3785**

Sharp.

◆ **SU3786**

Blunt.



**SENN-DINGMAN Retractor**

Double-ended,  
with one  
toothed and  
one flat blade.

**RH2732**

Overall length  
6-1/4in (15.9cm).



**LANGENBECK Retractor**

Right angle blade, length  
1-5/8in (4.1cm). With lip.

**SU3775**

Blade 12mm wide.  
Overall length  
8-1/2in (21.6cm).



**SEEBURGER Retractors**

Double-ended, set of 2.

**SU3640**

Overall length  
5-1/2in (14cm).

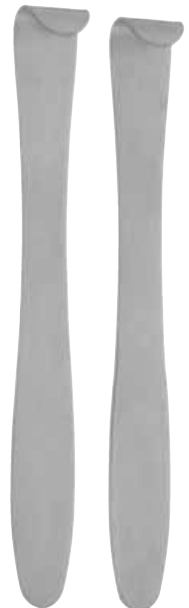

## Retractors

Écarteurs  
Wundspreizer/Retraktoren  
Divaricatori  
Separadores  
Retratores  
リトラクター

### MEYERDING Finger Retractors

Overall length 7in (17.8cm).

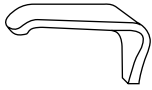

**SU3790**

Style A. Long blunt blade,  
1/4in x 11/16in (6mm x 17mm).



**SU3791**

Style B. Long toothed blade,  
3/16in x 5/8in (5mm x 16mm).



**SU3792**

Style C. Short toothed blade,  
1/8in x 1/4in (3mm x 6mm).



**SU3793**

Style D. Short blunt blade,  
1/8in x 3/8in (3mm x 10mm).



**SU3794**

Style E. Curved blunt blade,  
1/8in x 3/8in (3mm x 10mm).



**SU3795**

Style F. Curved, three-pronged sharp  
blade, 3/8in x 5/32in (10mm x 4mm).



### GREEN Goiter Retractor

Fully curved wire loop blade.

**SU3760**

Overall length  
8-3/4in (22.2cm).



### LAHEY Goiter Retractor

Right angle blade,  
length 1in (2.5cm).  
With lip.

**SU3770**

Overall length  
8in (20.3cm).



### McBURNEY Thyroid Retractor

Blade 3/4in x 3/8in (1.9cm x 1cm).

**SU3765**

Overall length  
7-3/8in (18.7cm).



### MAYO-COLLINS Retractors

Double-ended, set of two.

**SU3690**

Overall length  
5-7/8in (14.9cm).



Écarteurs  
Wundspreizer/Retraktoren  
Divaricatori  
Separadores  
Retradores  
リトラクター

**PARKER Retractors**

Double-ended. Set of two.

**SU3700**

Overall length  
6in (15.2cm).



**SU3701**

Overall length  
6-5/8in (16.8cm).

**BYFORD Retractors**

Double-ended, set of two.

**SU3685**

Overall length  
5-1/2in (14cm).

**SU3680**

Overall length  
6in (15.2cm).



**SISTRUNK Retractor**

Double-ended.  
Blade 3/8in  
(10mm) wide.

**SU3710**

Overall length  
6in (15.2cm).



**BOLEY Retractor**

Double-ended.

**SU3655**

Overall length  
6-1/4in (15.8cm).



**GOELET Retractor**

Double-ended.  
Blades 1-3/4in (4.4cm)  
and 1-1/2in (3.8cm) wide.

**SU3675**

Overall length  
7-1/4in (18.4cm).



**ROUX Retractors**

Double-ended.  
Overall length  
7-1/2in (19.1cm).

**SU3670**

Blades 7/8in (2.2cm) and  
1-1/2in (3.8cm) wide.

**SU3671**

Blades 1-3/8in (3.5cm) and  
1-7/8in (4.8cm) wide.



**U.S.A. Retractors**

Double-ended, set of two.

◆ **SU3660**

Overall length  
8in (20.3cm).



## Retractors

Écarteurs  
Wundspreizer/Retraktoren  
Divaricatori  
Separadores  
Retradores  
リトラクター

### ROCHESTER-FERGUSON Retractor

Double-ended.

**SU3650**

Overall length  
9in (22.9cm).



### Vein Retractors

**SU3730**

Blade 11mm wide.  
Overall length  
9-1/4in (23.5cm).

**SU3731**

Blade 15mm wide.  
Overall length  
9-1/2in (24.1cm).



### CUSHING Retractor

Straight. Plain edge.

◆ **NL1003**

Overall length  
8-3/4in (22.2cm).



### CUSHING Vein Retractors

**NL1010**

Overall length  
12-1/2in (31.8cm).

**NL1011**

Overall length  
14in (35.6cm).

**NL1012**

Overall length  
16in (40.6cm).



### CRILE Retractors

Double-ended.

**SU3720**

No. 1.  
Blades 1/8in x 7/16in  
(3mm x 11mm) and  
1/4in x 13/16in  
(6mm x 21mm).  
Overall length  
4-1/4in (10.8cm).

**SU3721**

No. 2.  
Blades 1/4in x 1/2in  
(6mm x 13mm) and  
3/8in x 7/8in  
(10mm x 21mm).  
Overall length  
6-1/8in (15.6cm).

**SU3722**

No. 3.  
Blades 5/8in x 1in  
(16mm x 25mm) and  
11/16in x 1-3/8in  
(17mm x 35mm).  
Overall length  
6-1/4in (15.9cm).

**SU3723**

No. 4.  
Blades 7/8in x 1-1/8in  
(22mm x 29mm) and  
1-1/8in x 1-3/4in  
(29mm x 44mm).  
Overall length  
7in (17.8cm).

**SU3724**

No. 5.  
Blades 1-1/8in x 1-5/8in  
(29mm x 41mm) and  
1-3/8in x 2in  
(35mm x 51mm).  
Overall length  
7in (17.8cm).

**SU3725**

No. 6.  
Blades 1-1/4in x 2-1/2in  
(32mm x 64mm) and  
1-3/8in x 2-3/4in  
(35mm x 70mm).  
Overall length  
8in (20.3cm).

**SU3726**

No. 7.  
Blades 1-5/8in x 3in  
(41mm x 76mm) and  
2in x 3-1/8in  
(51mm x 79mm).  
Overall length  
9in (22.9cm).



### LITTLE Retractor

Blade 5/8in x 7/16in  
(16mm x 11mm).

**SU3750**

Overall length  
7-3/8in (18.7cm).





Écarteurs  
Wundspreizer/Retraktoren  
Divaricatori  
Separadores  
Retradores  
リトラクター

**MURPHY Retractors**

Rakes are same size as  
VOLKMANN Retractors.  
Overall length  
7-3/4in (19.7cm).

**SU3570**

Sharp, three prongs.

**SU3571**

Blunt, three prongs.

**SU3572**

Sharp, four prongs.

**SU3573**

Blunt, four prongs.

**VOLKMAN Retractors**

Overall length  
4-1/2in (11.5cm).

**SU3540-002**

Sharp, 2 prong.

**SU3540-003**

Sharp, 3 prong.

**SU3540-004**

Sharp, 4 prong.

**SU3540-006**

Sharp, 6 prong.

**SU3530-002**

Blunt, 2 prong.

**SU3530-003**

Blunt, 3 prong.

**SU3530-004**

Blunt, 4 prong.

**SU3530-006**

Blunt, 6 prong.

**VOLKMANN Retractors**

Long pattern.  
Overall length  
8-3/4in (22.2cm).

**SU3550-01**

Blunt, two prongs.

**SU3551-01**

Blunt, three prongs.

**SU3552-01**

Blunt, four prongs.

**SU3553-01**

Blunt, five prongs.

**SU3554-01**

Blunt, six prongs.

**SU3560-01**

Sharp, two prongs.

**SU3561-01**

Sharp, three prongs.

◆ **SU3562-01**

Sharp, four prongs.

**SU3563-01**

Sharp, five prongs.

**SU3564-01**

Sharp, six prongs.

**ISRAEL Retractors**

Blunt. Overall length  
9-1/2in (24.1cm).

**SU3580**

Four prongs.

**SU3581**

Five prongs.

**KRASKY Retractor**

Curved blade with six  
sharp prongs.  
Blade 2in x 1in  
(5.1cm x 2.5cm) wide.

**CH860**

Overall length  
11in (27.9cm).

**C. W. MAYO Abdominal Retractors**

Angled blade.

**SU3450**

Blade 2-3/4in  
(7cm) wide.  
Overall length  
10-1/8in (25.7cm).

**SU3452**

Blade 3-1/8in  
(7.9cm) wide.  
Overall length  
9-3/4in (24.8cm).



## Retractors

Écarteurs  
Wundspreizer/Retraktoren  
Divaricatori  
Separadores  
Retratores  
リトラクター

### KELLY Retractors

#### SU3460

Blade 2in x 1-1/2in  
(5.1cm x 3.8cm) wide.  
Overall length  
10-1/2in (26.7cm).

#### SU3462

Blade 2-1/2in x 2in  
(6.4cm x 5.1cm) wide.  
Overall length  
10-1/2in (26.7cm).

#### SU3464

Blade 3in x 2-1/2in  
(7.6cm x 6.4cm) wide.  
Overall length  
11in (27.9cm).

#### SU3466

Blade 3-1/2in x 3in  
(8.9cm x 7.6cm) wide.  
Overall length  
11-1/4in (28.6cm).



### RICHARDSON Retractors

#### SU3470

Blade 1in x 3/4in  
(2.5cm x 1.9cm) wide.  
Overall length  
9-1/4in (23.5cm).

#### SU3472

Blade 1-1/4in x 1-1/8in  
(3.2cm x 2.9cm) wide.  
Overall length  
9-1/4in (23.5cm).

#### SU3474

Blade 1-1/2in x 1-1/2in  
(3.8cm x 3.8cm) wide.  
Overall length  
10in (25.4cm).

#### SU3476

Blade 2-1/2in x 1-5/8in  
(6.4cm x 4.1cm) wide.  
Overall length  
10in (25.4cm).

#### ◆ SU3478

Blade 2in x 3/4in  
(5.1cm x 1.9cm) wide.  
Overall length  
9-1/4in (23.5cm).



### RICHARDSON-EASTMAN Retractors

Double-ended.

#### SU3490

Set of two,  
small and large.

#### SU3490-001

Small.  
Blade 1-1/8in x 3/4in  
(2.9cm x 1.9cm) wide and  
1-1/2in x 1-1/8in  
(3.8cm x 2.9cm) wide.  
Overall length  
10in (25.4cm).

#### SU3490-002

Large.  
Blade 1-3/4in x 1-1/2in  
(4.4cm x 3.8cm) wide and  
2-1/2in x 1-5/8in  
(6.4cm x 4.1cm) wide.  
Overall length  
10-1/4in (26cm).

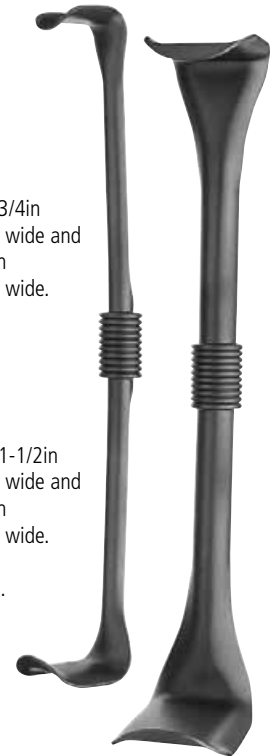

### RICHARDSON Retractors

Grip handle.  
Overall length  
9-1/2in (26.7cm).

#### SU3473

1-1-2in x 1in  
(3.8cm x 2.5cm).

#### SU3479

3/4in x 2in  
(1.8cm x 5.1cm).



### BERENS Mastectomy Skin Flap Retractor

Sharp. Blade length  
3-5/16in (8.4cm).

#### SU3600

Overall length  
7-7/8in (20cm).



### FOSS Gall Bladder Retractor

#### SU3400

Blade 10-1/4in x 2-1/4in  
(26cm x 5.7cm) wide.



Écarteurs  
Wundspreizer/Retraktoren  
Divaricatori  
Separadores  
Retratores  
リトラクター

**MURPHY Gall Bladder Retractor**

Blade 2in (5.1cm) wide.

**SU3410**

Working length  
7-1/2in (19.1cm).



**WEINBERG Vagotomy Retractor (Joe's Hoe)**

**SU3385**

Blade 4in x 6-1/2in  
(10.2cm x 16.5cm) wide.



**HARRINGTON Retractors**

Overall length 14-1/2in (36.8cm).

**CH1008**

Large blade 7-1/2in x 4-1/2in  
(19.1cm x 11.4cm) wide.

**CH1009**

Extra-large blade 7-1/2in x 6-1/2in  
(19.1cm x 16.5cm) wide.

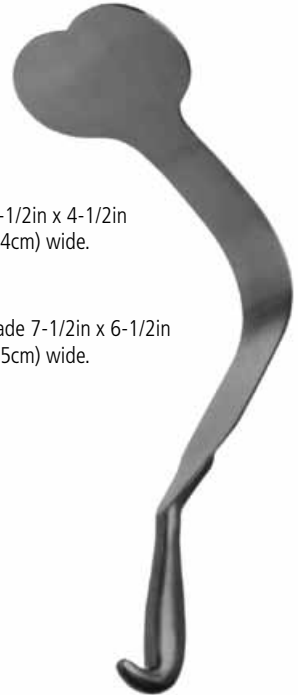

**HARRINGTON-PEMBERTON Retractor**

Blade 7-1/2in x 2-1/2in  
(19.1cm x 6.4cm) wide,  
thickened distal end.

**CH1010**

Overall length  
14-1/2in (36.8cm).



**HARRINGTON Splanchnic Retractors**

Flat, deeply curved, springy blade with  
thickened distal end.  
Overall length  
12-1/2in (31.7cm).

**CH1000**

Blade 5in x 1-1/2in  
(12.7cm x 3.8cm) wide.

**CH1005**

Blade 5in x 2-1/2in  
(12.7cm x 6.4cm) wide.



**B. E. GLASS Abdominal Retractor**

**SU3380**

Blade 6in x 3-1/4in  
(15.5cm x 8.3cm) wide.  
Overall length  
9-3/4in (24.5cm).



## Retractors

Écarteurs  
Wundspreizer/Retraktoren  
Divaricatori  
Separadores  
Retratores  
リトラクター

### FLEXSTEEL Ribbon Retractors

#### SU3336

Blade 1/2in (1.2cm) wide.  
Overall length 8in (20.3cm).

#### SU3338

Blade 5/8in (1.5cm) wide.  
Overall length 8in (20.3cm).

#### SU3340

Blade 1in (2.5cm) wide.  
Overall length 13in (33cm).

#### SU3342

Blade 1-1/4in (3.2cm) wide.  
Overall length 13in (33cm).

#### SU3344

Blade 1-1/2in (3.8cm) wide.  
Overall length 13in (33cm).

#### SU3346

Blade 2in (5.1cm) wide.  
Overall length 13in (33cm).

#### SU3348

Blade 3in (7.6cm) wide.  
Overall length 13in (33cm).



### FLEXSTEEL Retractors

With handle.  
Overall length  
17-5/8in (44.8cm).

#### SU3350

Blade 13in x 1in  
(33cm x 2.5cm) wide.

#### SU3356

Blade 13in x 2in  
(33cm x 5.1cm) wide.



### Looking for a specific product?

When you know the catalog number or the name of the product you need, you can use the index at the end of this book to direct you to the page on which the product is described. If you do not find the specific instruments you are looking for, please contact your local V. Mueller sales representative or Customer Support at **800.323.9088**.

### DEAVER Retractors

#### SU3306

Blade 3/4in (1.9cm) wide.  
Overall length  
6-1/2in (16.5cm).

#### SU3307

Blade 3/4in (1.9cm) wide.  
Overall length  
8-1/2in (21.6cm).

#### SU3300

Blade 1in (2.5cm) wide.  
Overall length  
9in (22.9cm).

#### SU3301

Blade 1in (2.5cm) wide.  
Overall length  
10in (25.4cm).

#### SU3303

Blade 1in (2.5cm) wide.  
Overall length  
12-3/8in (31.4cm).

#### SU3302

Blade 1in (2.5cm) wide.  
Overall length  
13in (33cm).

#### SU3304

Blade 1-1/2in (3.8cm) wide.  
Overall length  
12-3/4in (32.4cm).

#### SU3305

Blade 2in (5.1cm) wide.  
Overall length  
13in (33cm).

#### SU3308

Blade 3in (7.6cm) wide.  
Overall length  
11-3/4in (30cm).

#### SU3317

Extra-long.  
Blade 1in (2.5cm) wide.  
Overall length  
15-1/2in (39.4cm).

#### SU3318

Extra-long.  
Blade 2in (5.1cm) wide.  
Overall length  
15-1/2in (39.4cm).



### WALTER-DEAVER Retractors

Hollow handle.

#### SU3326

Size 3.  
Colonial blade,  
1in (2.5cm) wide.  
Overall length  
12-1/2in (31.5cm)

#### SU3320

Size 4.  
Blade 1in  
(2.5cm) wide.  
Overall length  
12in (30.5cm).

#### SU3322

Size 4-1/2.  
Blade 1-1/2in  
(3.8cm) wide.  
Overall length  
12in (30.5cm).

#### SU3324

Size 5.  
Blade 2in  
(5.1cm) wide.  
Overall length  
12in (30.5cm).



**DeBAKEY-COOLEY-DEAVER-Type Retractors**

Overall length  
13-1/2in (34.3cm).

**SU3314**

Blade 5in x 7in  
(12.7cm x 17.8cm) wide.

**SU3310**

Blade 7-1/2in x 3in  
(19.1cm x 7.6cm) wide.

**SU3312**

Blade 7-1/2in x 5in  
(19.1cm x 12.7cm) wide.

**SU3316**

Blade 7-1/2in x 7in  
(19.1cm x 17.8cm) wide.



**ST. MARKS Pelvis Retractor Blades**

**SU3932-010**

Angled.  
Overall length  
11-1/2in (29.2cm).

**SU3932-012**

Angled.  
Overall length  
13-1/8in (33.2cm).

**SU3932-014**

Straight.  
Overall length  
13-1/8in (33.2cm).



**MAHORNER Thyroid Retractor**

Overall length 9in (22.8cm).

**SU2941-176**

Opening 3-7/8in (10cm) wide.

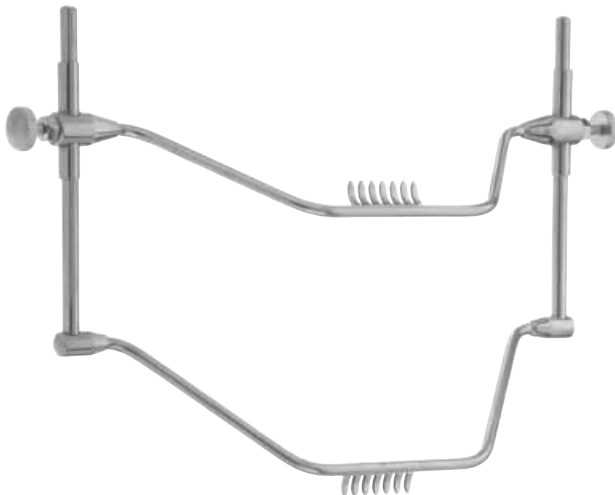

**SLOAN Goiter Retractors**

Spring wire, self-retaining.  
Overall length  
4-7/8in (12.4cm).

**SU3150**

Left.

**SU3151**

Right.

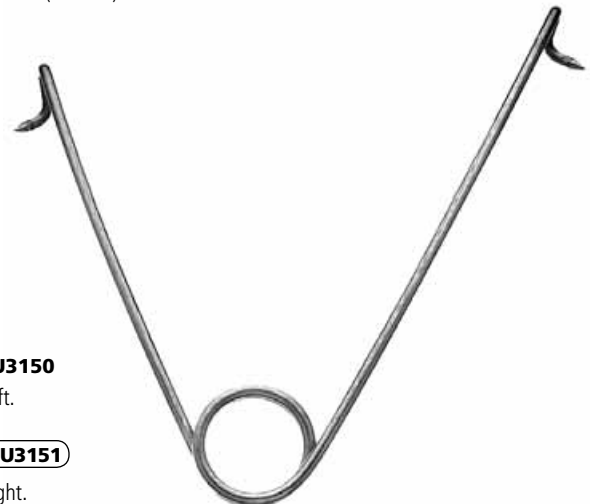

**Retractors**

Écarteurs  
 Wundspreizer/Retraktoren  
 Divaricatori  
 Separadores  
 Retratores  
 リトラクター

**Spring Wire Retractors**



**SU3161**  
 Size 1, small prongs.  
 Overall length 5in (12.7cm).

**SU3162**  
 Size 2, medium prongs.  
 Overall length 5-1/8in (13cm).

**SU3163**  
 Size 3, large prongs.  
 Overall length 9in (22.9cm).

**Spring Wire Retractors**

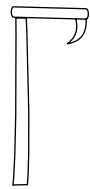

**SU3171**  
 Size 1.  
 1 x 1 prongs.  
 Overall length 3in (7.6cm).

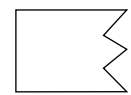

**SU3172**  
 Size 2.  
 3 x 3 prongs.  
 Overall length 3-1/2in (8.9cm).

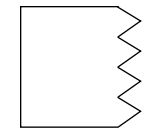

**SU3173**  
 Size 3.  
 4 x 4 prongs.  
 Overall length 4-1/2in (11.4cm).

**FARR Spring Retractors**

Sharp points.

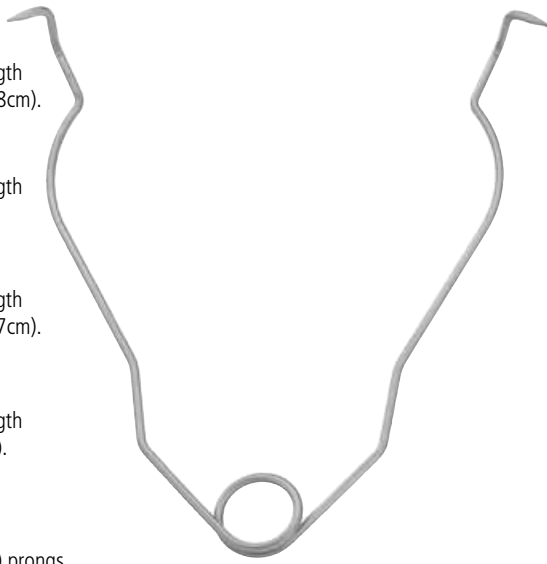

**SU3181**  
 Overall length 1-1/2in (3.8cm).

**SU3182**  
 Overall length 2in (5cm).

**SU3183**  
 Overall length 2-1/4in (5.7cm).

**SU3185**  
 Overall length 3in (7.6cm).

**SU3186**  
 Size 2.  
 1in (2.4cm) prongs.  
 Overall length 5-1/2in (14cm).

**Custom etching**

Custom etching is available on stainless steel surgical instruments on new orders as they are purchased. Ask your customer support representative at **800.323.9088** for more information.

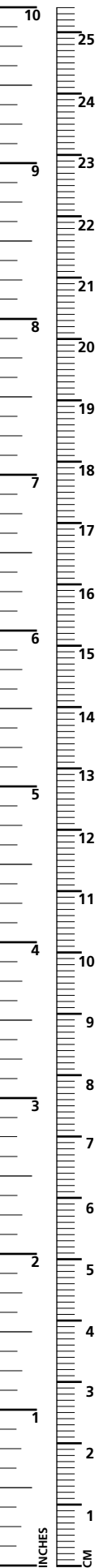

**ALM Minor Surgery Retractors**

4 x 4 blunt prongs.

**SU3147**

Total opening 2in (5.1cm).  
Overall length  
2-3/4in (7cm).

**SU3148**

Total opening 2-1/4in (5.7cm).  
Overall length  
3in (7.6cm).



**Automatic Skin Retractors**

Cross-action, with ratchet lock. 4 x 4 prongs.  
Overall length 4in (10.2cm).

◆ **SU3145**

Sharp prongs.

◆ **SU3146**

Blunt prongs.



**THEIS Vein Retractor**

4 x 5 sharp prongs.

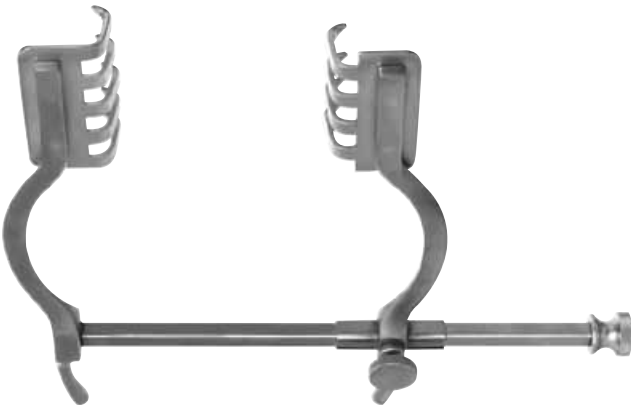

**SU3140**

Self retaining, sharp.  
Total opening 3-3/8in (8.6cm).

**GOSSET Retractor**

Self-retaining. Wire blades.  
Depth 1-1/4in (3.2cm).

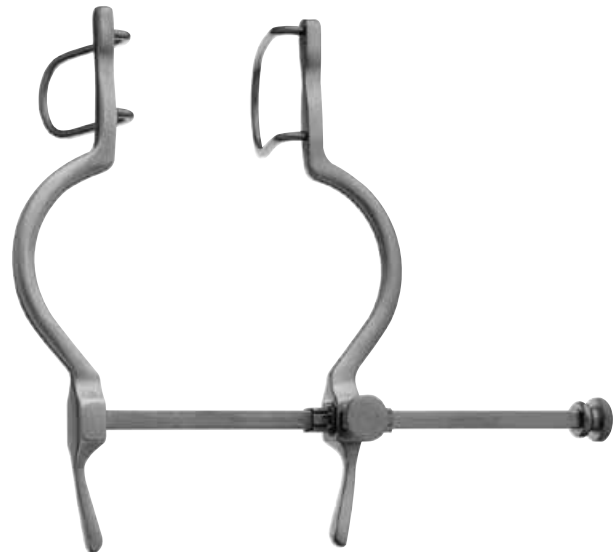

**SU3130**

Operative opening  
4in (10.2cm).

## Retractors

Écarteurs  
Wundspreizer/Retraktoren  
Divaricatori  
Separadores  
Retratores  
リトラクター

### GELPI Perineal Retractors

Self-retaining. Sharp tenaculum prongs.

#### GL503

Total opening 1-3/8in (3.5cm).  
Arm length 1-1/4in (3.2cm).  
Overall length  
3-1/2in (8.9cm).

#### GL502

Total opening 1-5/8in (4.1cm).  
Arm length 2in (5cm).  
Overall length  
4-1/2in (11.4cm).

#### ◆ GL501

Total opening 2-1/8in (5.4cm).  
Arm length 3in (7.6cm).  
Overall length  
5-1/4in (13.3cm).

#### ◆ GL500

Total opening 3-1/4in (8.3cm).  
Arm length 4-3/4in (12.1cm).  
Overall length  
7-1/4in (18.4cm).



### GELPI Perineal Retractor

Self-retaining.  
Balls stops on sharp  
tenaculum prongs.

#### GL510

Total opening 3-1/4in (8.3cm).  
Arm length 4-3/4in (12.1cm).  
Overall length  
7in (17.8cm).

#### B-0076

Total opening 2-3/4in (7cm).  
Arm length 4-1/2in (11.5cm),  
3in (7.6cm) deep hooks.  
Overall length  
6in (15.2cm).



### WILTSE-GELPI Retractor

Self-retaining. Sharp tenaculum  
prongs.

#### ◆ NL5370

Total opening 5in (12.7cm).  
Arm length 7-1/2in (19cm).  
2-3/4in (7cm) deep hooks.  
Overall length  
11in (27.9cm).



### Mini WEITLANER Retractors

Self-retaining. 2 x 3 prongs.  
Total opening 2-1/4in (5.7cm).  
Overall length 4-1/4in (10.8cm).

#### ◆ OS5531

Blunt prongs.

#### ◆ OS5532

Sharp prongs.





**WEITLANER Retractors**

3 x 4 prongs.

◆ **SU3110**

Sharp prongs.  
Overall length  
5-1/2in (14cm).

◆ **SU3110-001**

Blunt prongs.  
Overall length  
5-1/2in (14cm).

◆ **SU3112**

Sharp prongs.  
Overall length  
6-1/2in (16.5cm).

◆ **SU3112-001**

Blunt prongs.  
Overall length  
6-1/2in (16.5cm).

**SU3113**

Delicate. Sharp prongs.  
Overall length  
6-1/2in (16.5cm).

◆ **SU3114**

Sharp prongs.  
Overall length  
8in (20.3cm).

◆ **SU3114-001**

Blunt prongs.  
Overall length  
8in (20.3cm).

**SU3116**

Sharp prongs.  
Overall length  
9-1/2in (24.1cm).

**SU3116-001**

Blunt prongs.  
Overall length  
9-1/2in (24.1cm).

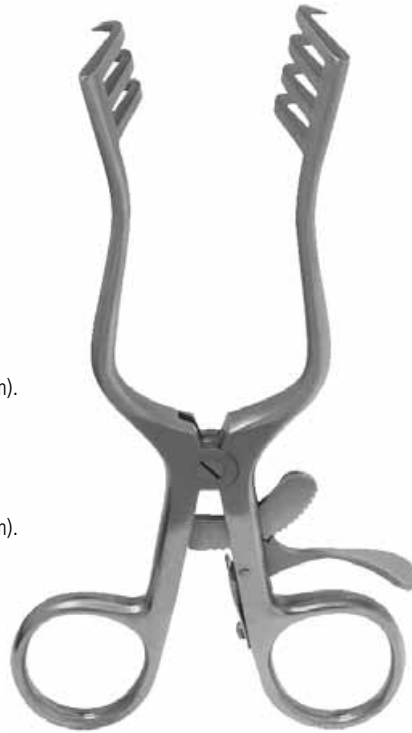

**BECKMAN Retractor**

Hinged arms, 3 x 4 sharp prongs.

◆ **SU3195**

Overall length  
6-3/4in (17.1cm).



**BECKMAN Goiter Retractor**

4 x 4 sharp prongs.

◆ **SU3190**

Overall length  
12in (30.5cm).



**HAMMOND Winged Retractor Blade**

Blade 3-3/8in x 5-3/8in  
(8.6cm x 13.7cm) wide.

◆ **SU3045**

Overall length  
8-1/2in (21.6cm).

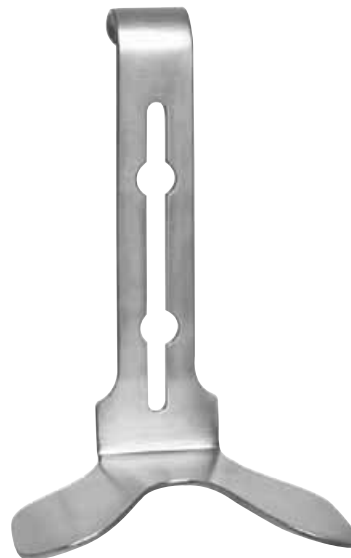

**MAYO-COLLINS Appendectomy Retractor**

Self-retaining with ratchet catch.

◆ **SU3105**

Overall length  
6-3/4in (17.1cm).

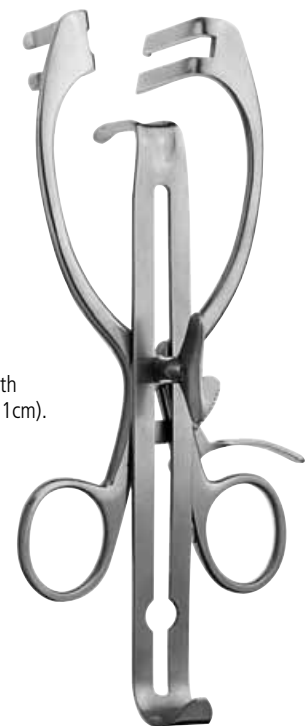

## Retractors

Écarteurs  
Wundspreizer/Retraktoren  
Divaricatori  
Separadores  
Retratores  
リトラクター

### BALFOUR Pediatric Abdominal Retractor

Includes one 1in (2.5cm) wide center blade and two 1in (2.5cm) deep wire side blades. Operative opening 3-1/2in (8.9cm).

#### SU3008

Overall width  
5-3/8in (13.7cm).



### O'SULLIVAN-O'CONNOR Abdominal Retractor

#### ◆ SU3055

Includes 3 center blades,  
2 blades 1-3/4in (4.4cm) wide,  
and 1 blade, 2-3/4in (7cm) wide,  
and 2 mounted side blades,  
2-3/4in (7cm) deep.



### V. Mueller® BALFOUR Abdominal Retractor

Includes one 3in (7.6cm) wide and 3-1/8in (7.9cm) wide center blades and two 2-1/2in (6.4cm) deep and 3-1/2in (8.9cm) deep wire side blades. Operative opening 9-1/4in (23.5cm).

#### ◆ SU3040

Overall width 12in (30.5cm).

#### SU3040-025

BALFOUR wire side blades. 2-1/2in (6.4cm) deep. Sold in pairs.

#### SU3040-035

BALFOUR wire side blades. 3-1/2in (8.9cm) deep. Sold in pairs.

#### SU3040-050

BALFOUR wire side blades. 5in (12.7cm) deep. Sold in pairs.

#### SU3040-070

BALFOUR wire side blades. 7in (17.8cm) deep. Sold in pairs.

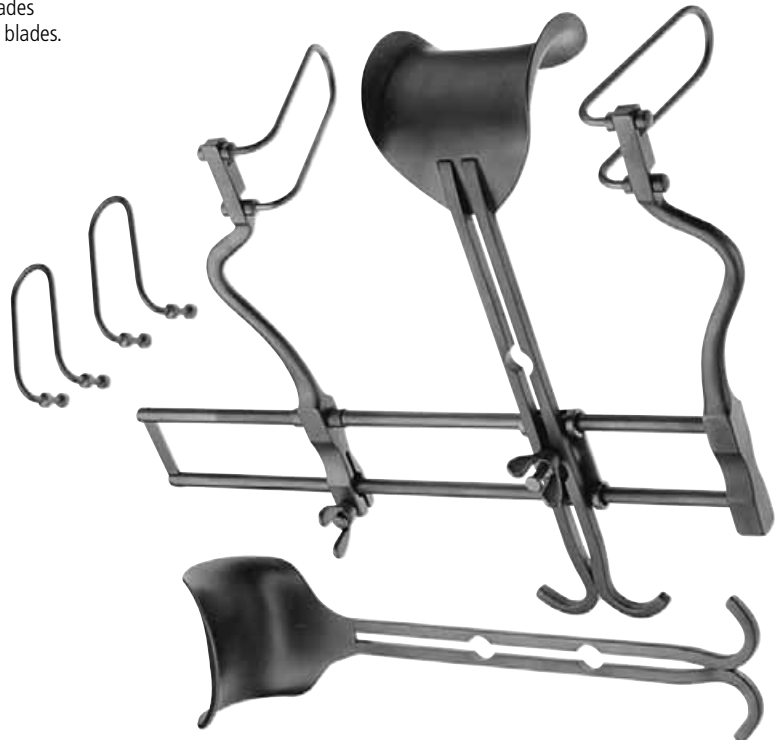

**GIBSON-BALFOUR Abdominal Retractor**

Includes one 3-1/8in (7.9cm) wide center blade and two each 2-1/2in (6.4cm) deep and 3-1/2in (8.9cm) deep wire side blades. Operative opening 13-1/4in (33.7cm).

**SU3042**

Overall width 16in (40.6cm).

**BALFOUR Retractors**

Includes one 3in (7.6cm) wide solid center blade and two 2-3/8in (6cm) deep side blades. Operative opening 7-1/4in (18.4cm). Overall width 10in (25.4cm).

◆ **SU3000**

Wire side blades.

**SU3010**

Solid side blades.

**BALFOUR Retractor Deep Model**

Includes one 3in (7.6cm) wide solid center blade and two 3-1/4in (8.3cm) deep wire side blades. Operative opening 9-1/4in (23.5cm).

◆ **SU3005**

Overall width 12in (30.5cm).

**BALFOUR Retractors**

Includes one 3in (7.6cm) wide center blade, two 2-1/2in (6.4cm) deep and two 3-1/2in (8.9cm) deep wire side blades.

◆ **SU3060**

Operative opening 8-1/2in (21.6cm). Overall width 10in (27cm).

◆ **SU3062**

Operative opening 10-1/2in (26.7cm). Overall width 13in (33cm).

**BALFOUR Side Blade****SU3064**

BALFOUR wire side blades. 2-1/2in (6.4cm) deep. Sold in pairs.

**SU3065**

BALFOUR wire side blades. 3-1/2in (8.9cm) deep. Sold in pairs.

**SU3066**

BALFOUR wire side blades. 4in (10.2cm) deep. Sold in pairs.

**SU3067**

BALFOUR solid side blades. 2-1/2in (6.4cm) deep. Sold in pairs.

**SU3068**

BALFOUR solid side blades. 3-1/2in (8.9cm) deep. Sold in pairs.

**SU3069**

BALFOUR solid side blades. 4in (10.2cm) deep. Sold in pairs.



## Retractor Blades

Larmes d'écarteur  
Wundspreizerblätter  
Lame divaricatore  
Cuchillas de separadores  
Lâminas de retrator  
リトラクターのブレード

### Fourth Blade Extensions

Extension arm for BALFOUR retractor. Recommended for use with SU3060 and SU3062. Blade not included.

#### SU3012

For right arm.

#### SU3013

For left arm.



### BALFOUR Center Blades

#### SU3020

Small.  
2-5/8in (6.7cm) wide.

#### SU3021

Medium.  
3in (7.6cm) wide.

#### SU3022

Large.  
3-1/8in (7.9cm) wide.

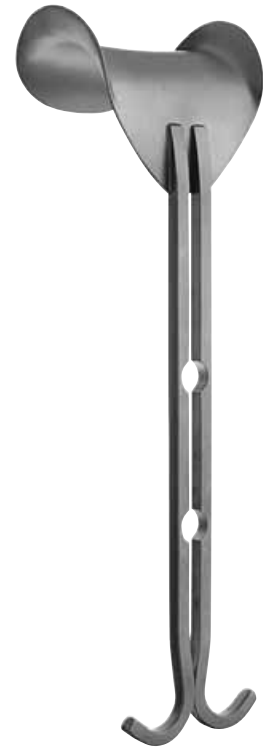

### HORGAN Center Blade

#### SU3026

5in x 2-1/8in  
(12.7cm x 5.4cm) wide.



### DIXON Center Blades

Malleable.

#### SU3030

6-3/4in x 2in  
(17.1cm x 5.1cm) wide.

#### SU3032

10-1/2in x 2-1/4in  
(26.7cm x 5.7cm) wide.



### YU-HOLTGREWE Malleable Blade

For use with BALFOUR retractors.

#### SU3043

2-1/2in x 7in  
(6.3cm x 17.8cm).



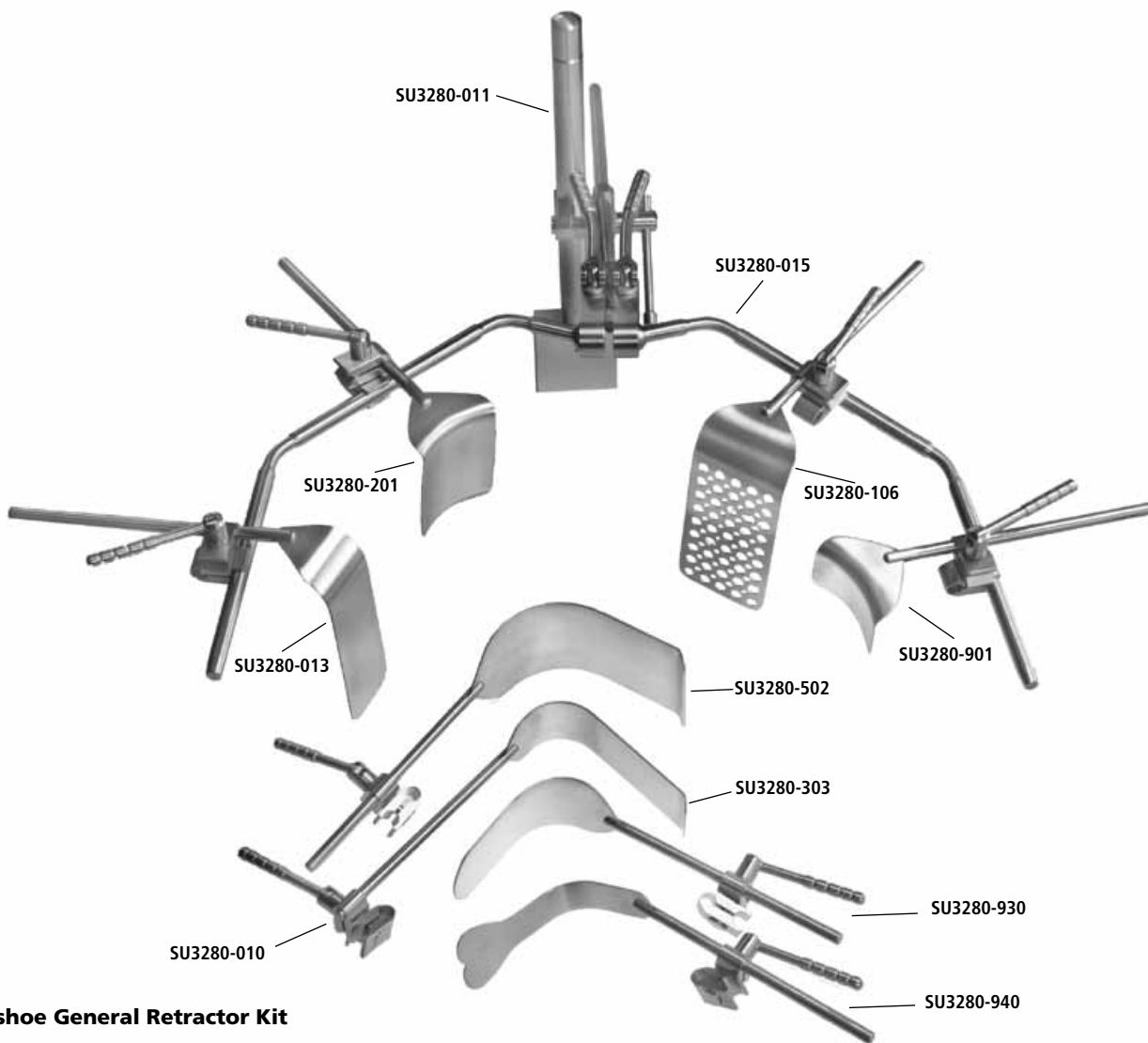

**Horseshoe General Retractor Kit**

**SU3280**

Set includes the following:

Cat. No.	Description	Set Quantity
SU3280-011	Table clamp with vertical post.	1
SU3280-015	Retractor frame.	1
SU3280-010	Retractor clamp.	10
SU3280-012	Extension arm.	1
SU3280-901	Mayo swivel blades 2-3/4in x 2in.	2
SU3280-801	Mayo swivel blade 3-1/2in x 2in.	1
SU3280-201	Fence swivel blade.	1
SU3280-502	Splanchnic ribbon swivel blade 2in x 4-1/2in.	1
SU3280-402	Splanchnic ribbon swivel blade 2in x 6in.	1
SU3280-303	Renal swivel blade 1in x 6in.	2
SU3280-930	Deaver swivel blade 2-3/4in x 4-1/2in.	1
SU3280-103	Malleable swivel blade 2in x 6-1/2in.	1
SU3280-106	Malleable swivel blade 3in x 6-1/2in.	1
SU3280-940	HARRINGTON "sweetheart" blades 2in x 5in.	1

## Retractor Blades

Larmes d'écarteur  
Wundspreizerblätter  
Lame divaricatore  
Cuchillas de separadores  
Lâminas de retrator  
リトラクターのブレード

### Horseshoe General Retractor Kit

Set includes the following:

#### SU3280-010

Retractor clamp.

#### SU3280-011

Table clamp with vertical post.

#### SU3280-012

Extension arm.

#### SU3280-015

Frame only.



### Malleable Swivel Blades

For use with the Horseshoe retractor set.

#### SU3280-102

Solid blade.  
2in x 6-1/2in (5.1cm x 16.5cm).

#### SU3280-103

Perforated blade.  
2in x 6-1/2in (5.1cm x 16.5cm).

#### SU3280-104

Aluminum. Perforated blade.  
2in x 6-1/2in (5.1cm x 16.5cm).

#### SU3280-101

Solid. 2in x 8in (5.1cm x 20.3cm).

#### SU3280-105

Solid blade.  
3in x 6-1/2in (7.6cm x 16.5cm).

#### SU3280-106

Perforated blade.  
3in x 6-1/2in (7.6cm x 16.5cm).

#### SU3280-107

Aluminum.  
Perforated blade.  
3in x 6-1/2in (7.6cm x 16.5cm).

#### SU3280-108

Large size. Solid blade.  
3in x 8in (7.6cm x 20.3cm).

#### SU3280-109

Large size. Solid blade.  
4in x 8in (10.2cm x 20.3cm).



### Bladder Swivel Blade

For use with the Horseshoe retractor set.

#### SU3280-110

3in x 6-1/2in (7.6cm x 16.5cm)



### Fence Swivel Blades

For use with the Horseshoe retractor set.

#### SU3280-201

4in x 6in (10.2cm x 15.2cm).

#### SU3280-202

Aluminum. 4in x 6in (10.2cm x 15.2cm).

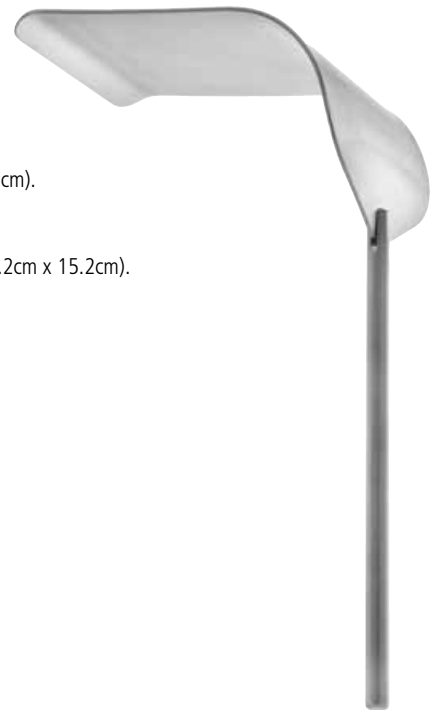

Larmes d'écarteur  
Wundspreizerblätter  
Lame divaricatore  
Cuchillas de separadores  
Lâminas de retrator  
リトラクターのブレード

**Renal Swivel Blades**

For use with the Horseshoe retractor set.

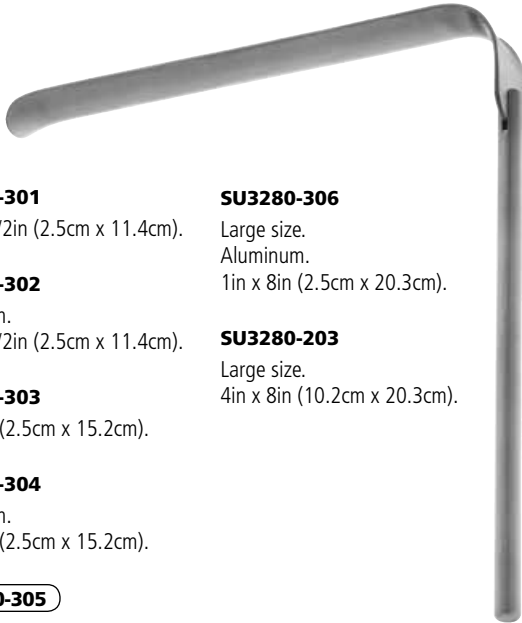

**SU3280-301**

1in x 4-1/2in (2.5cm x 11.4cm).

**SU3280-302**

Aluminum.  
1in x 4-1/2in (2.5cm x 11.4cm).

**SU3280-303**

1in x 6in (2.5cm x 15.2cm).

**SU3280-304**

Aluminum.  
1in x 6in (2.5cm x 15.2cm).

**SU3280-305**

Large size.  
1in x 8in (2.5cm x 20.3cm).

**SU3280-306**

Large size.  
Aluminum.  
1in x 8in (2.5cm x 20.3cm).

**SU3280-203**

Large size.  
4in x 8in (10.2cm x 20.3cm).

**Splanchnic Ribbon Swivel Blades**

For use with the Horseshoe retractor set.



**SU3280-401**

1-1/2in x 4in (3.8cm x 10.2cm).

**SU3280-403**

1-1/2in x 6in (3.8cm x 15.2cm).

**SU3280-501**

Aluminum.  
1-1/2in x 6in (3.8cm x 15.2cm).

**SU3280-502**

2in x 4-1/2in (5.1cm x 11.4cm).

**SU3280-503**

Aluminum.  
2in x 4-1/2in (5.1cm x 11.4cm).

**SU3280-402**

2in x 6in (5.1cm x 15.2cm).

**SU3280-504**

Aluminum.  
2in x 6in (5.1cm x 15.2cm).

**SU3280-505**

2in x 8in (5.1cm x 20.3cm).

**SU3280-506**

Aluminum.  
2in x 8in (5.1cm x 20.3cm).

**Groin Swivel Blade**

For use with the Horseshoe retractor set.



**SU3280-601**

1-1/2in x 3-1/2in (3.8cm x 8.9cm).

**BOOKWALTER-Type Blade**

Malleable. Small size.



**SU3280-701**

1/2in x 6in (1.2cm x 15.2cm).

## Retractor Blades

Larmes d'écarteur  
Wundspreizerblätter  
Lame divaricatore  
Cuchillas de separadores  
Lâminas de retrator  
リトラクターのブレード

### MAYO Swivel Blades

For use with the Horseshoe retractor set.

#### SU3280-903

2in x 2in (5.1cm x 5.1cm).

#### SU3280-901

2-3/4in x 2in (7cm x 5.1cm).

#### SU3280-902

Aluminum. 2-3/4in x 2in (7cm x 5.1cm).

#### SU3280-801

3-1/2in x 2in (8.9cm x 5.1cm).

#### SU3280-802

Aluminum. 3-1/2in x 2in (8.9cm x 5.1cm).

#### SU3280-803

3-1/2in x 2-3/4in (8.9cm x 7cm).



### DEAVER Swivel Blades

For use with the Horseshoe retractor set.

#### SU3280-930

2-3/4in x 4-1/2in (7cm x 11.4cm).

#### SU3280-931

Aluminum.  
2-3/4in x 4-1/2in (7cm x 11.4cm).

#### SU3280-904

2-3/4in x 8in (7cm x 20.3cm).

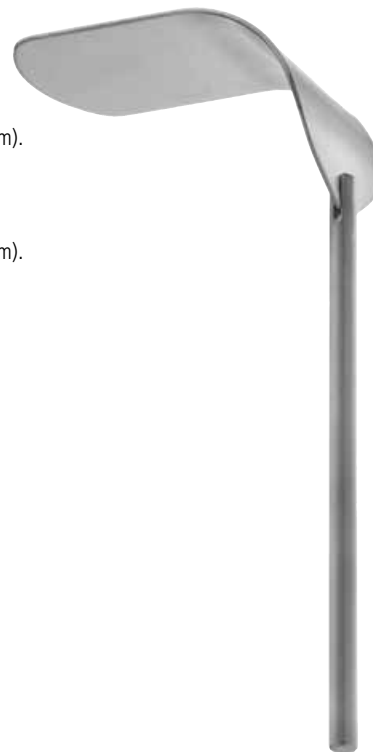

### HARRINGTON Swivel Blades

"Sweetheart" style. For use with the Horseshoe retractor set.

#### SU3280-940

2in x 5in (5.1cm x 12.7cm).

#### SU3280-941

Aluminum. 2in x 5in (5.1cm x 12.7cm).

#### SU3280-942

3in x 6-1/2in (7.6cm x 16.5cm)

#### SU3280-943

Large size. 4-1/2in x 10in (11.4cm x 25.4cm).

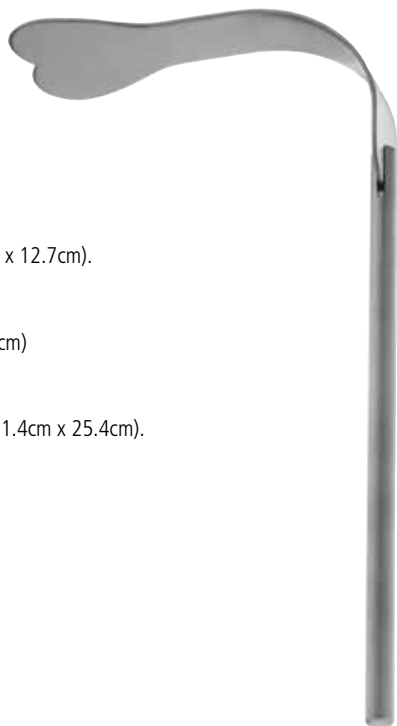

### KELLY Swivel Blades

For use with the Horseshoe retractor set.

#### SU3280-950

2in x 4in (5.1cm x 10.2cm).

#### SU3280-951

2in x 5in (5.1cm x 12.7cm).

#### SU3280-952

2in x 6in (5.1cm x 15.2cm).

#### SU3280-953

Modified. 3in x 2-1/2in (7.6cm x 6.3cm).

#### SU3280-954

Modified. 3in x 4in (7.6cm x 10.2cm).

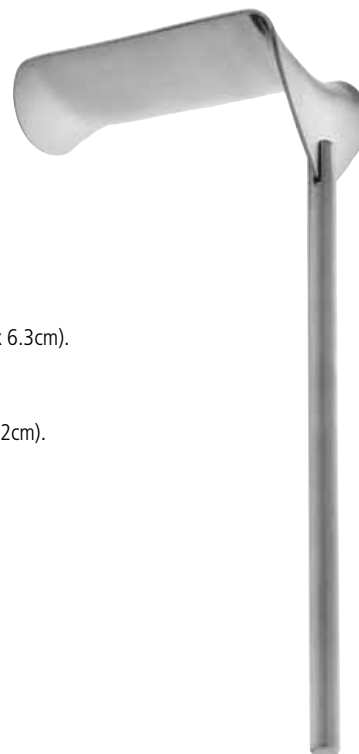

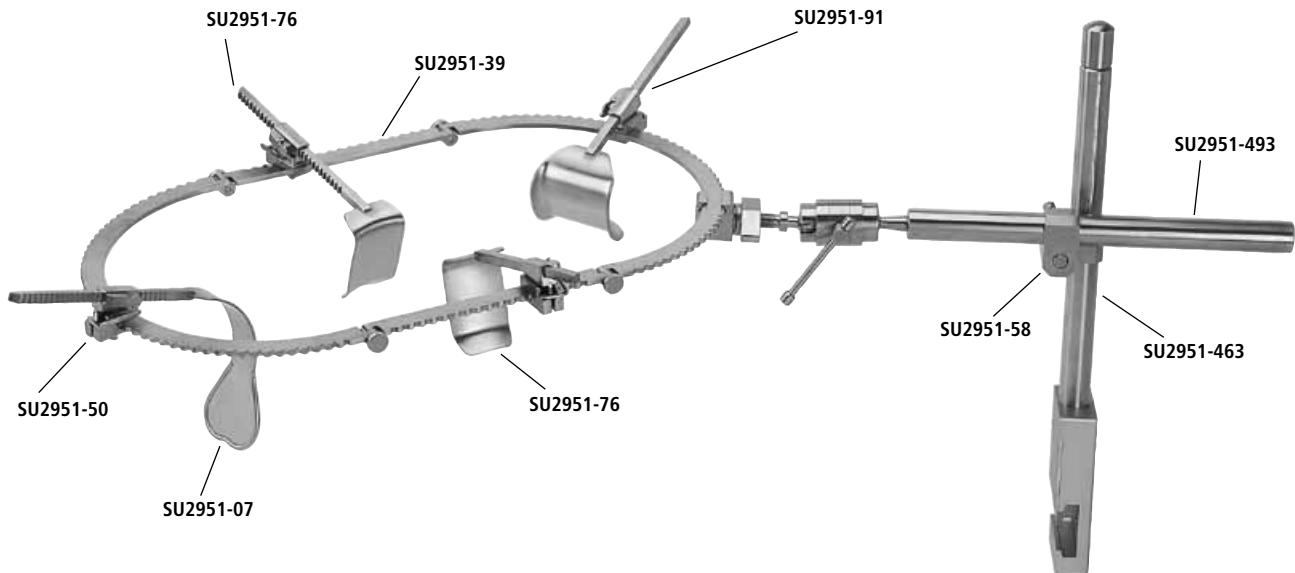

**Universal Ring Retractor Kit**

Set components may be purchased individually. Set includes the following:

◆ **SU2951-13C**

Cat. No.	Description	Set Quantity
<b>SU2951-32</b>	Oval Ring. Medium. I.D. 10-1/2in x 15in (26.7cm x 38.1cm)	1
<b>SU2951-39</b>	Segmented Oval Ring. Medium. I.D. 10-1/2in x 19-1/2in (26.7cm x 49.5cm)	1
<b>SU2951-50</b>	Advanced Tilting Blade Clamps	6
<b>SU2951-59</b>	Non-Tilting Blade Clamps	2
<b>SU2951-463</b>	Table Clamp. With vertical post. Overall length 17-1/2in (44cm)	1
<b>SU2951-493</b>	Horizontal Flex Bar	1
<b>SU2951-563</b>	Horizontal Solid Bar. Overall length 15-1/2in (39.4cm)	1
<b>SU2951-58</b>	Post Clamp. For 1in bar	1
<b>SU2951-76</b>	Kelly Retractor Blades. 2in x 3in wide (5.1cm x 7.6cm)	2
<b>SU2951-77</b>	Kelly Retractor Blade. 2in x 4in wide (5.1cm x 10.2cm)	1
<b>SU2951-78</b>	Kelly Retractor Blade. 2in x 5in wide (5.1cm x 12.7cm)	1
<b>SU2951-79</b>	Kelly Retractor Blade. 2in x 6in wide (5.1cm x 15.2cm)	1
<b>SU2951-813</b>	Malleable Blade. 1-1/2in x 6in wide (3.8cm x 15.2cm)	1
<b>SU2951-843</b>	Malleable Blades. 2in x 6in wide (5.1cm x 15.2cm)	2
<b>SU2951-863</b>	Malleable Blades. 3in x 6in wide (7.6cm x 15.2cm)	1
<b>SU2951-07</b>	HARRINGTON Sweetheart Blade. 2-1/2in x 5in wide (6.4cm x 12.7cm)	1
<b>SU2951-91</b>	BALFOUR Bladder Blade. 3in x 3-1/2in (7.6cm x 8.9cm)	1
<b>SU2952-21</b>	GELPI Retractor Blade	1

## Retractors

Écarteurs  
Wundspreizer/Retraktoren  
Divaricatori  
Separadores  
Retratores  
リトラクター

### Table Clamp

With vertical post. Overall length  
17-1/2in (44.5cm).

◆ **SU2951-463**



### Post Clamp

◆ **SU2951-58**



### Horizontal Flex Bar

◆ **SU2951-493**



### Extension Bar

◆ **SU2951-51**

Bar diameter 1in.  
Overall length  
13-1/2in (34.3cm).



### Horizontal Solid Bar

◆ **SU2951-563**

Overall length  
15-1/2in (39.4cm).



### Oval Rings

◆ **SU2951-31**

Small.  
Inside dimensions  
8-1/2in x 12in (21.6cm x 30.5cm).

◆ **SU2951-32**

Medium.  
10-1/2in x 15in (26.7cm x 38.1cm).

◆ **SU2951-33**

Large.  
Inside dimension  
12-1/2in x 18-1/2in (31.8cm x 47cm).

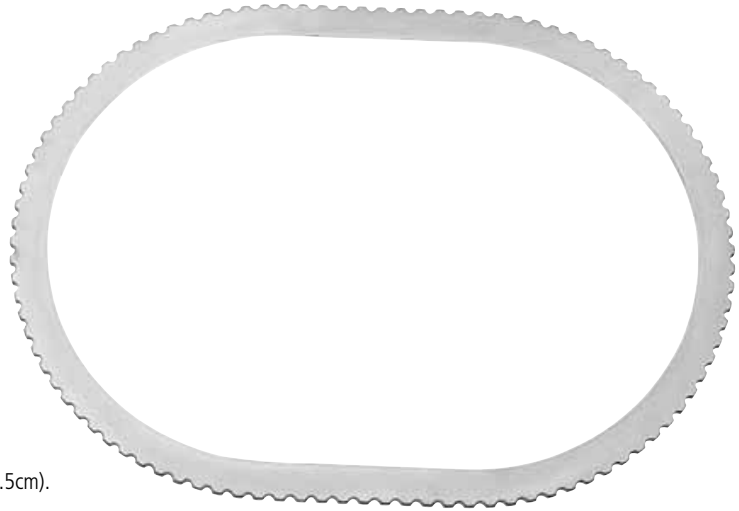

**Segmented Oval Ring**

Original-style.

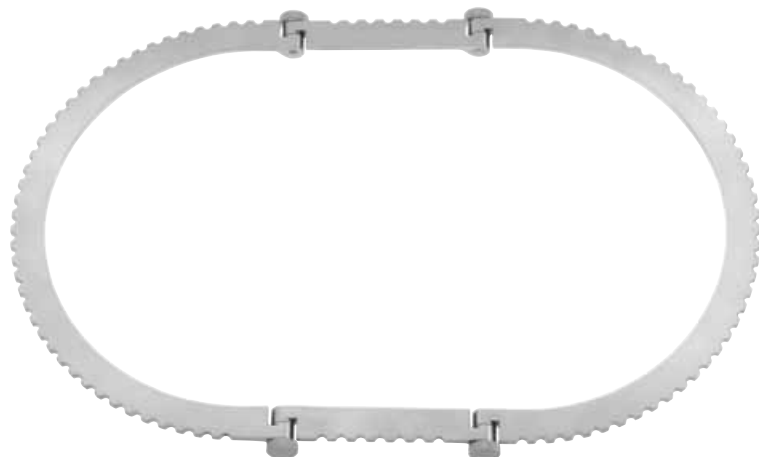

**SU2951-38**

Small. Inside dimension 8-1/2in x 14in (21.6cm x 35.6cm). Includes two - 4in (10.2cm) straight ring segments.

◆ **SU2951-39**

Medium. Inside dimension 10-1/2in x 19-1/2in (26.6cm x 49.5cm). Includes two - 8in (20.3cm) straight ring segments.

**SU2951-30**

Large. Inside dimension 12-1/2in x 19-1/2in (31.7cm x 49.5cm). Includes two - 6in (15.2cm) straight ring segments.

**Round Rings**

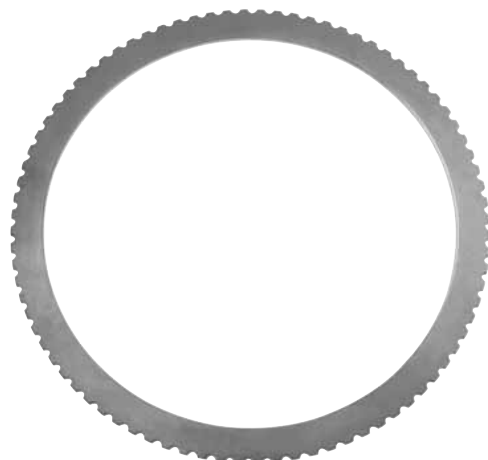

**SU2951-34**

Small. Inside diameter 8-1/2in (21.6cm)

**SU2951-35**

Medium. Inside diameter 10-1/2in (26.7cm).

**SU2951-36**

Large. Inside diameter 12-1/2in (31.8cm).

**Universal Ring Retractor Screw**

For segmented only.  
Sold 1 each.

**SU2951-37**



**Advanced Tilting Blade Clamp**

Original-type.

◆ **SU2951-50**

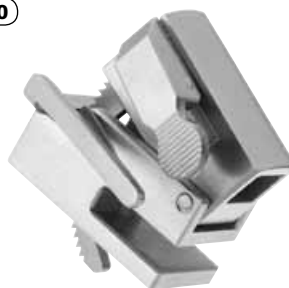

**Non-Tilting Blade Clamp**

◆ **SU2951-59**



## Retractor Blades

Larmes d'écarteur  
Wundspreizerblätter  
Lame divaricatore  
Cuchillas de separadores  
Lâminas de retrator  
リトラクターのブレード

### Malleable Blades



**SU2951-813**  
1-1/2in x 6in (3.8cm x 15.2cm).

◆ **SU2951-843**  
2in x 6in (5.1cm x 15.2cm).

◆ **SU2951-863**  
3in x 6in (7.6cm x 15.2cm).

### KELLY Retractor Blades

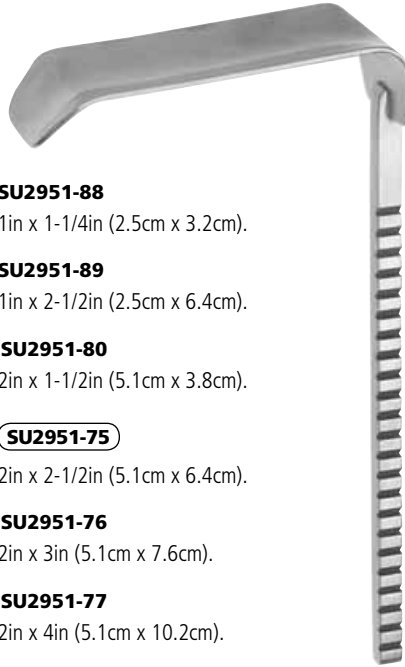

**SU2951-88**  
1in x 1-1/4in (2.5cm x 3.2cm).

**SU2951-89**  
1in x 2-1/2in (2.5cm x 6.4cm).

◆ **SU2951-80**  
2in x 1-1/2in (5.1cm x 3.8cm).

**SU2951-75**  
2in x 2-1/2in (5.1cm x 6.4cm).

◆ **SU2951-76**  
2in x 3in (5.1cm x 7.6cm).

◆ **SU2951-77**  
2in x 4in (5.1cm x 10.2cm).

**SU2951-78**  
2in x 5in (5.1cm x 12.7cm).

**SU2951-79**  
2in x 6in (5.1cm x 15.2cm).

### BALFOUR Bladder Blades

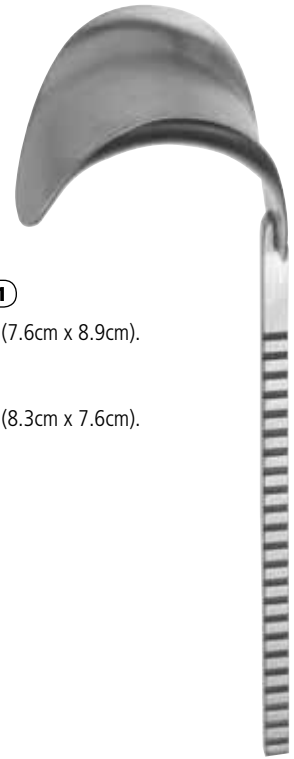

◆ **SU2951-91**  
3in x 3-1/2in (7.6cm x 8.9cm).

**SU2951-92**  
3-1/4in x 3in (8.3cm x 7.6cm).

### DEAVER Retractor Blades

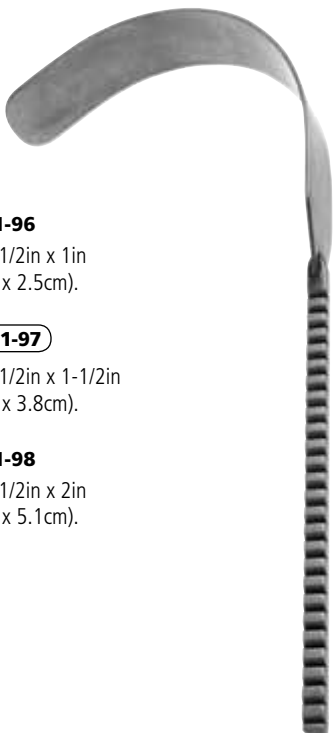

**SU2951-96**  
Blade 4-1/2in x 1in  
(11.4cm x 2.5cm).

**SU2951-97**  
Blade 4-1/2in x 1-1/2in  
(11.4cm x 3.8cm).

**SU2951-98**  
Blade 4-1/2in x 2in  
(11.4cm x 5.1cm).

### Skin Incision Blade

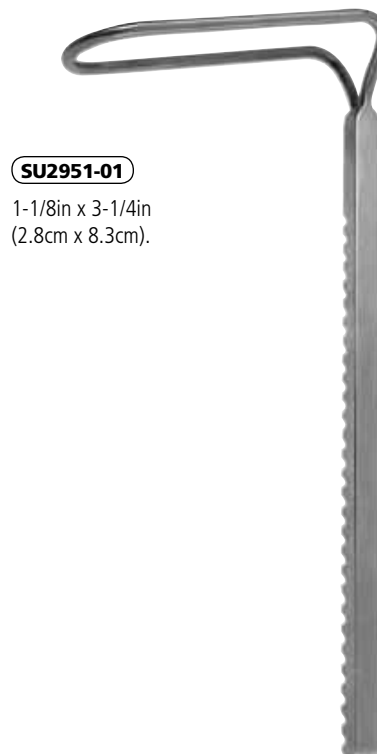

**SU2951-01**  
1-1/8in x 3-1/4in  
(2.8cm x 8.3cm).

### HARRINGTON Blades

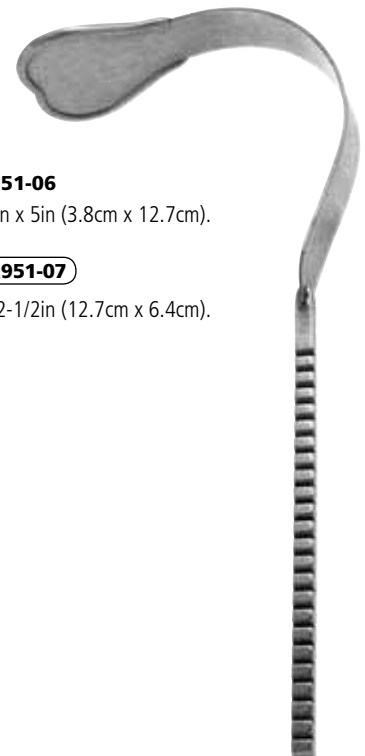

**SU2951-06**  
1-1/2in x 5in (3.8cm x 12.7cm).

◆ **SU2951-07**  
5in x 2-1/2in (12.7cm x 6.4cm).

Larmes d'écarteur  
 Wundspreizerblätter  
 Lame divaricatore  
 Cuchillas de separadores  
 Láminas de retrator  
 リトラクターのブレード

**ST. MARKS Bookwalter-Type Retractor Blades**

Angled tip.

**SU2953-50**

Overall length  
 7-1/2in (19cm).

**SU2953-55**

Extended bar.  
 Overall length  
 5-1/2in (14cm).



**GELPI Retractor Blade**

**SU2952-21**



**YU-HOLTGREWE Malleable Blade**

For the universal ring retractor set.

**SU2953-40**

2-1/2in x 7in  
 (6.3cm x 17.8cm).



**MEYERDING Retractor Blades**

**SU2952-32**

3-1/3in x 1in (8.5cm x 2.5cm).

**SU2952-31**

2-1/3in x 2/3in (5.9cm x 1.7cm).



## Retractor Blades

Larmes d'écarteur  
Wundspreizerblätter  
Lame divaricatore  
Cuchillas de separadores  
Lâminas de retrator  
リトラクターのブレード

### RIBBON Retractor Blades

For use with the Universal  
Ring Retractor Systems.

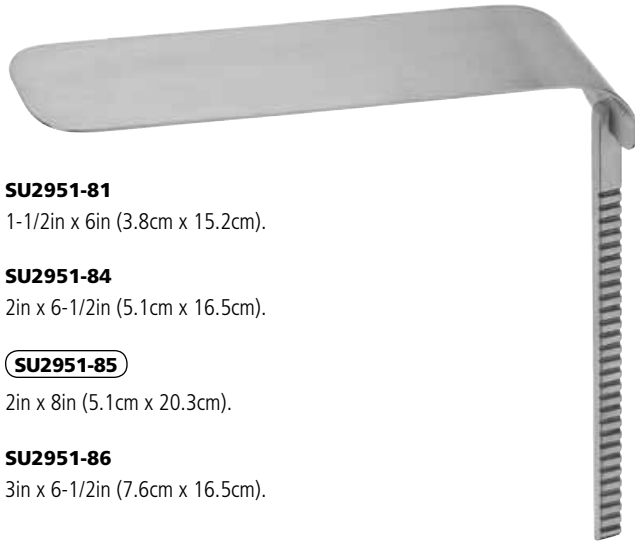

#### SU2951-81

1-1/2in x 6in (3.8cm x 15.2cm).

#### SU2951-84

2in x 6-1/2in (5.1cm x 16.5cm).

#### SU2951-85

2in x 8in (5.1cm x 20.3cm).

#### SU2951-86

3in x 6-1/2in (7.6cm x 16.5cm).

### RICHARDSON Retractor Blades

For use with the Universal  
Ring Retractor Systems.

#### SU2952-42

3/4in x 1in (1.9cm x 2.5cm).

#### SU2952-43

3/4in x 2in (1.9cm x 5.1cm).

#### SU2952-44

1in x 1-1/4in (2.5cm x 3.2cm).



### Rake Retractor Blades

For use with the Universal  
Ring Retractor Systems.

#### SU2952-71

3 prongs.

#### SU2952-72

4 prongs.

#### SU2952-73

6 prongs.



### Hand-Held Retractor Adapter

#### SU2952-11

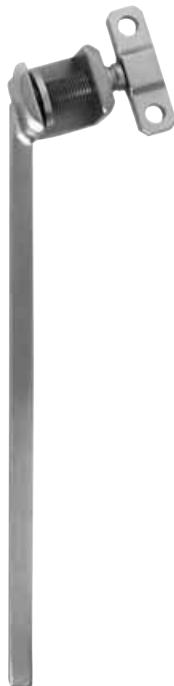

### Universal Ring Retractor Segments

Includes two straight  
ring segments.

#### SU2952-61

Small.  
4in (10.2cm). Pair.

#### SU2952-62

Medium.  
6in (15.2cm). Pair.

#### SU2952-63

Large.  
8in (20.3cm). Pair.



**Rectal Universal Ring Retractor Kit**

Contains a round ring, plus large and small rectal blades that can be used with any standard universal ring retractor system. Components may be purchased separately.

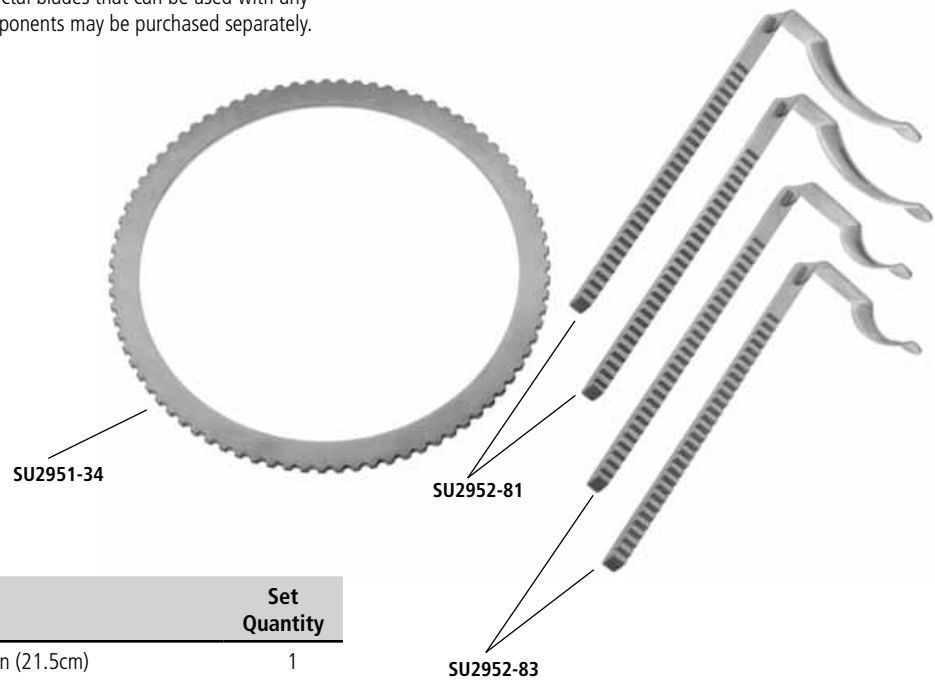
**SU2951-13K**

Includes the following:

Cat. No.	Description	Set Quantity
<b>SU2951-34</b>	Round ring, Small, 8-1/2in (21.5cm)	1
<b>SU2952-81</b>	Rectal blade, Small, 7/8in x 2-3/4in (2.2cm x 7cm)	2
<b>SU2952-83</b>	Rectal blade, Large, 7/8in x 4in (2.3cm x 10cm)	2

**Customer Support**

Our highly trained, centralized V. Mueller customer support team is available to take your calls from 7:00 a.m. to 6:00 p.m. (CST), M-F. This group is dedicated to providing a full range of support services, including:

- Order placement
- Order inquiries
- Delivery information
- Product information
- Pricing inquiries

If we can be of assistance, please call us at **800.323.9088**.

## Retractors

Écarteurs  
Wundspreizer/Retraktoren  
Divaricatori  
Separadores  
Retratores  
リトラクター

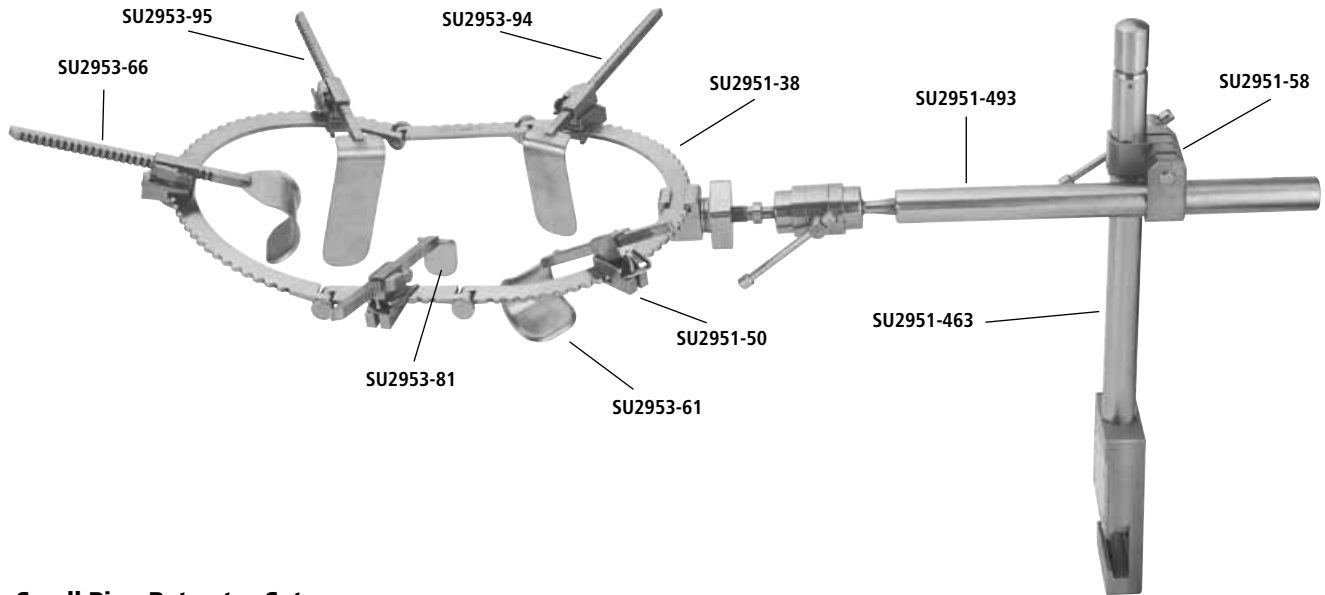

### Small Ring Retractor Set

Components may be purchased separately.

#### SU2951-13P

Set includes the following:

Cat. No.	Description	Set Quantity
SU2951-463	Table clamp with vertical post	1
SU2951-493	Horizontal flex bar	1
SU2951-50	Advanced tilting blade clamp	5
SU2951-38	Segmented oval ring. Small. With 4in ring segments	1
SU2951-58	Post clamp	1
SU2953-66	MAYO retractor blade 2in X 2in (5cm x 5cm)	2
SU2953-61	MAYO retractor blade 1-1/4in x 1-1/4in (3.2cm x 3.2cm)	2
SU2953-71	Malleable pediatric blade 3/4in x 2in (1.9cm x 5cm)	1
SU2953-74	Malleable pediatric blade 3/4in x 3in (1.9cm x 7.6cm)	1
SU2953-81	Malleable pediatric blade 1in x 1in (2.5cm x 2.5cm)	1
SU2953-85	Malleable pediatric blade 1in x 4in (2.5cm x 10.2cm)	1
SU2953-87	Malleable pediatric blade 1in x 5in (2.5cm x 12.7cm)	1
SU2953-94	Malleable pediatric blade 1-1/2in x 3in (3.8cm x 7.6cm)	1
SU2953-95	Malleable pediatric blade 1-1/2in x 4in (3.8cm x 10.2cm)	1



Larmes d'écarteur  
Wundspreizerblätter  
Lame divaricatore  
Cuchillas de separadores  
Lâminas de retrator  
リトラクターのブレード

**ST. MARKS Bookwalter-Type Retractor Blades**

Angled tip.

**SU2953-50**

Overall length  
7-1/2in (19cm).

**SU2953-55**

Extended bar.  
Overall length  
5-1/2in (14cm).



**MAYO Retractor Blade**

**SU2953-61**

Blade 1-1/4in x 1-1/4in  
(3.2cm x 3.2cm) wide.

**SU2953-66**

Blade 2in x 2in  
(5cm x 5cm) wide.

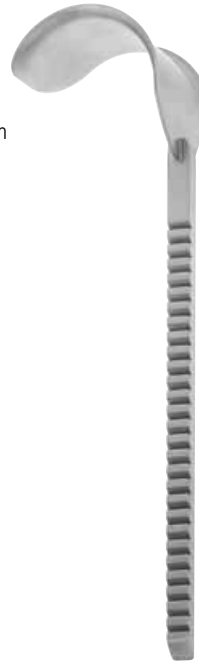

**Malleable Small Blades**

**SU2953-71**

Blade 3/4in x 2in (1.9cm x 5cm).

**SU2953-74**

Blade 3/4in x 3in (1.9cm x 7.6cm).

**SU2953-81**

Blade 1in x 1in (2.5cm x 2.5cm).

**SU2953-85**

Blade 1in x 4in (2.5cm x 10.2cm).

**SU2953-87**

Blade 1in x 5in (2.5cm x 12.7cm).

**SU2953-94**

Blade 1-1/2in x 3in (3.8cm x 7.6cm).

**SU2953-95**

Blade 1-1/2in x 4in (3.8cm x 10.2cm).

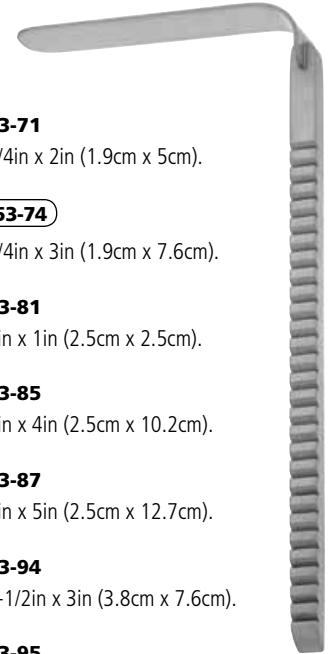

**Lateral Retractor Blade**

For the Vaginal Universal Retractor Set.

◆ **SU2953-17**

1in x 3in  
(2.5cm x 7.6cm).



**DEAVER Retractor Blades**

For the Vaginal Universal Retractor Set.

**SU2953-21**

1in x 3-1/2in  
(2.5cm x 8.9cm).

**SU2953-22**

1in x 5in  
(2.5cm x 12.7cm).

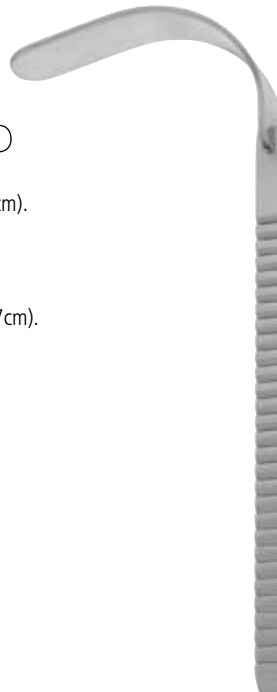

**Posterior Blade**

For the Vaginal Universal Retractor Set.

**SU2953-19**

1in x 4-1/2in  
(2.5cm x 11.4cm).

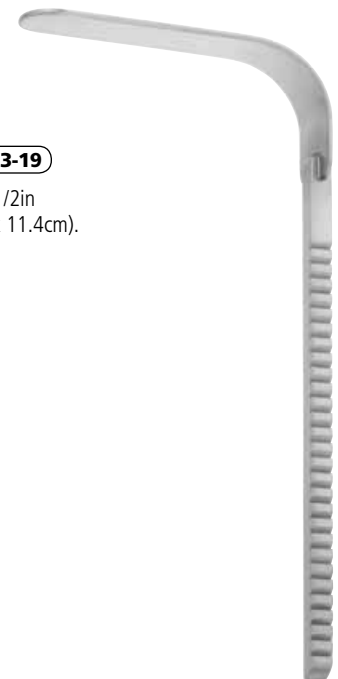

## Retractors

Écarteurs  
Wundspreizer/Retraktoren  
Divaricatori  
Separadores  
Retratores  
リトラクター

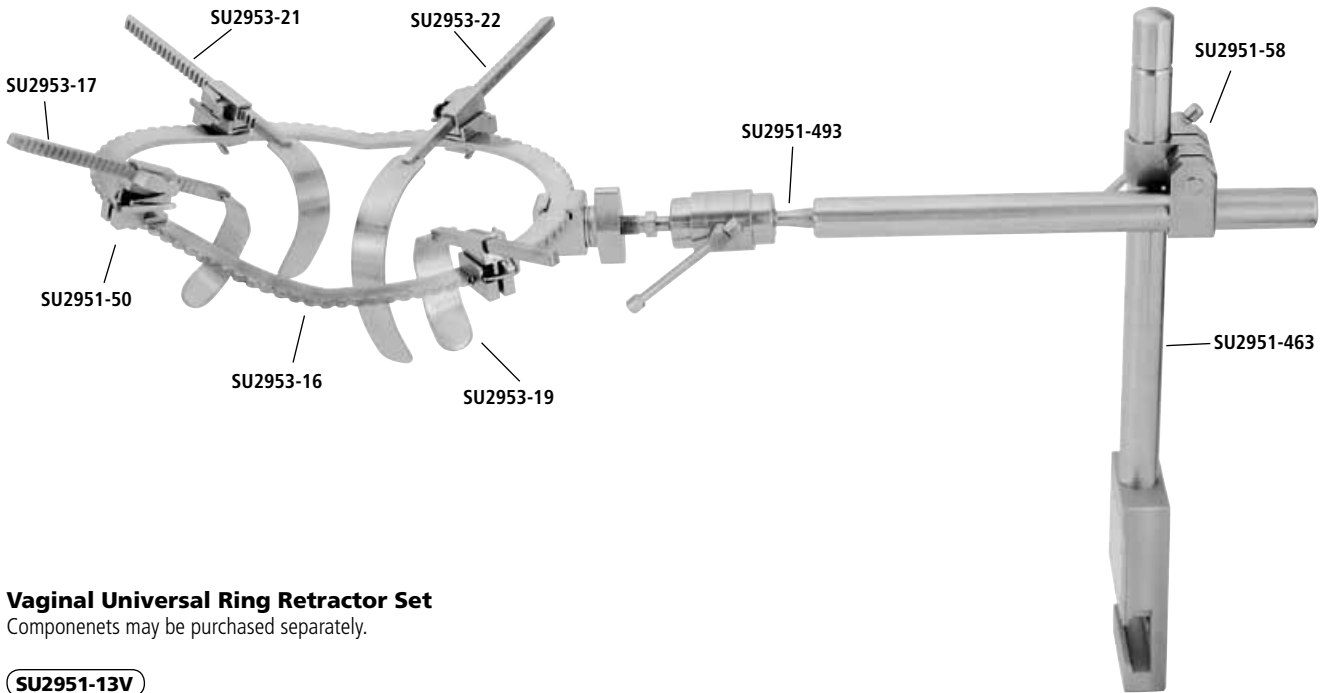

### Vaginal Universal Ring Retractor Set

Components may be purchased separately.

#### SU2951-13V

Set includes the following:

Cat. No.	Description	Set Quantity
<b>SU2953-16</b>	Vaginal Retractor Ring. Angled 20°. Inside dimensions 8in x 10-1/2in (20.3cm x 26.6cm).	1
<b>SU2953-17</b>	Lateral Retractor Blades. 1in x 3in (2.5cm x 7.6cm).	2
<b>SU2953-21</b>	DEAVER Retractor Blades. 1in x 3-1/2in (2.5cm x 8.9cm).	1
<b>SU2953-22</b>	DEAVER Retractor Blade. 1in x 5in (2.5cm x 12.7cm).	1
<b>SU2953-19</b>	Posterior Blade. 1in x 4-1/2in (2.5cm x 11.4cm).	1
<b>SU2951-58</b>	Post Clamp.	1
<b>SU2951-493</b>	Horizontal Flex Bar.	1
<b>SU2951-463</b>	Table Clamp. With vertical post. Overall length 17-1/2in (44.5cm).	1
<b>SU2951-50</b>	Advanced Tilting Blade Clamps. Original-type.	6

### Vaginal Retractor Ring

For the Vaginal Universal Retractor Set.

#### SU2953-16

Angled 20°.  
Inside dimensions  
8in x 10-1/2in  
(20.3cm x 26.6cm).

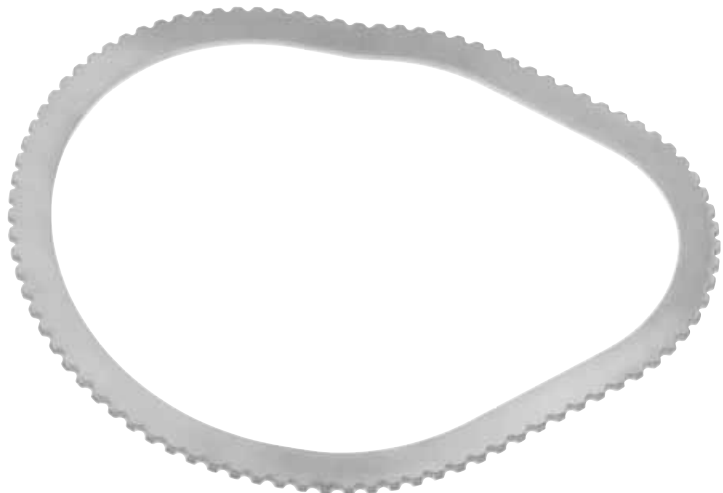

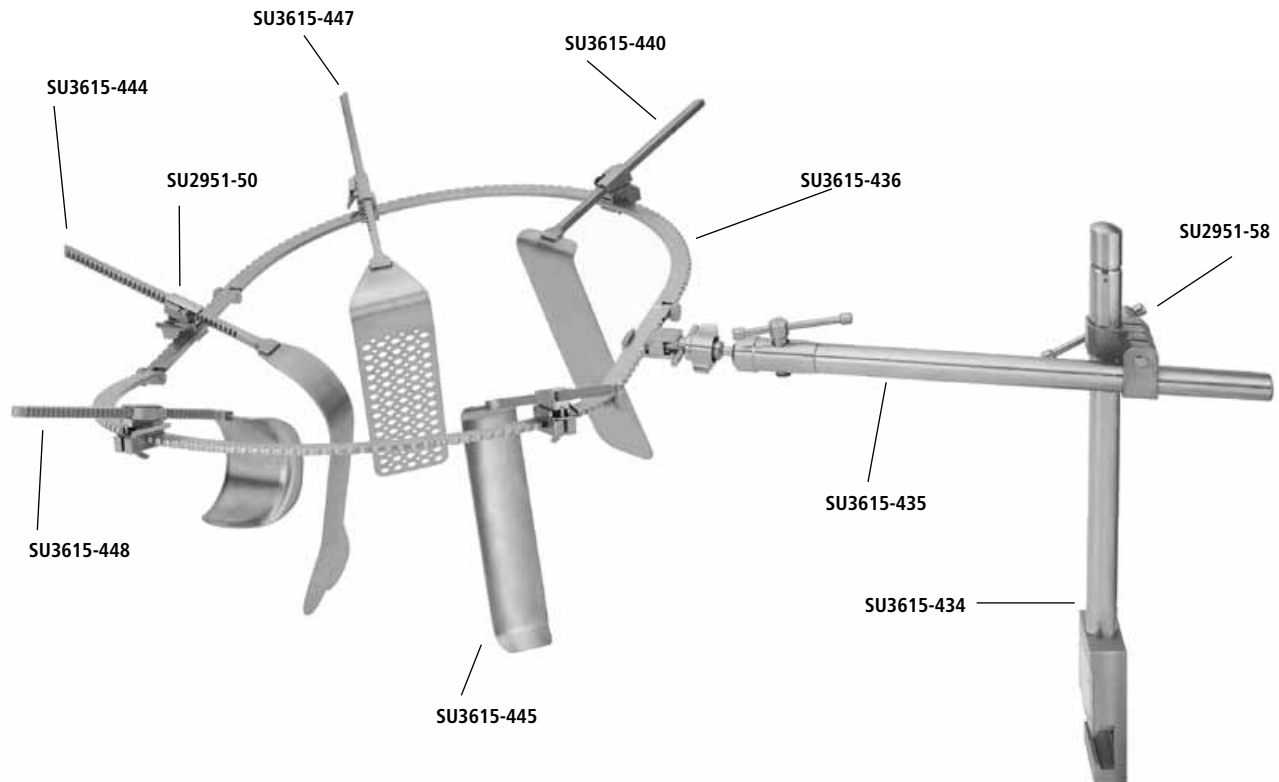

### Large Universal Ring Retractor Set

Set components may be purchased individually.

#### SU3615-433

Set includes the following:

Cat. No.	Description	Set Quantity
<b>SU3615-434</b>	Table Clamp. With vertical post. Overall length 24in (61cm)	1
<b>SU3615-435</b>	Horizontal Flex Bar	1
<b>SU3615-436</b>	Segmented Ring	1
<b>SU2951-50</b>	Advanced Tilting Blade Clamps	8
<b>SU2951-58</b>	Post clamp	1
<b>SU3615-439</b>	Malleable Blade. 2in x 10in (5.1cm x 25.4cm)	1
<b>SU3615-440</b>	Malleable Blade. 3in x 10 in (7.6cm x 25.4cm)	1
<b>SU3615-441</b>	Malleable Blade. 4in x 10in (10.2cm x 25.4cm)	1
<b>SU3615-442</b>	Malleable Blade. 3in x 12in (7.6cm x 30.5cm)	1
<b>SU3615-443</b>	Malleable Blade. 4in x 12in (10.2cm x 30.5cm)	1
<b>SU3615-444</b>	HARRINGTON Blade. 3-1/2in x 10in (8.9cm x 25.4cm)	1
<b>SU3615-445</b>	KELLY Blade. 2in x 8in (5.1cm x 20.3cm)	1
<b>SU3615-446</b>	Large Blades. 2in x 6-1/2in (5.1cm x 16.5cm)	2
<b>SU3615-447</b>	Large Blades. 3in x 6-1/2in (7.6cm x 16.5cm)	2
<b>SU3615-448</b>	BALFOUR Blades. 3-1/2in x 2-3/4in (8.9cm x 7cm)	2

## Retractor Blades

Larmes d'écarteur  
Wundspreizerblätter  
Lame divaricatore  
Cuchillas de separadores  
Lâminas de retrator  
リトラクターのブレード

### Table Clamp

With vertical post.  
Length 24in (61cm).

**SU3615-434**

Bariatric vertical  
post with clamp.



### Horizontal Flex Bar

**SU3615-435**



### Segmented Ring

**SU3615-436**

16in x 23in  
(40.6cm x 58.4cm).

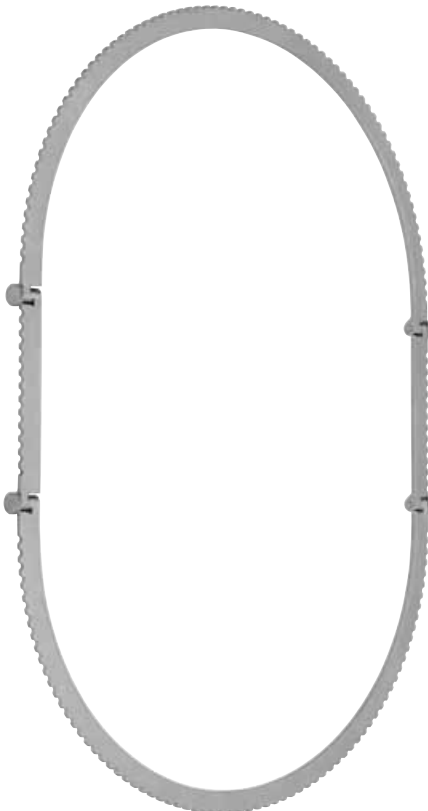

### Malleable Blades

**SU3615-439**

2in x 10in (5.1cm x 25.4cm).

**SU3615-440**

3in x 10in (7.6cm x 25.4cm).

**SU3615-441**

4in x 10in (10.2cm x 25.4cm).

**SU3615-442**

3in x 12in (7.6cm x 30.5cm).

**SU3615-443**

4in x 12in (10.2cm x 30.5cm).

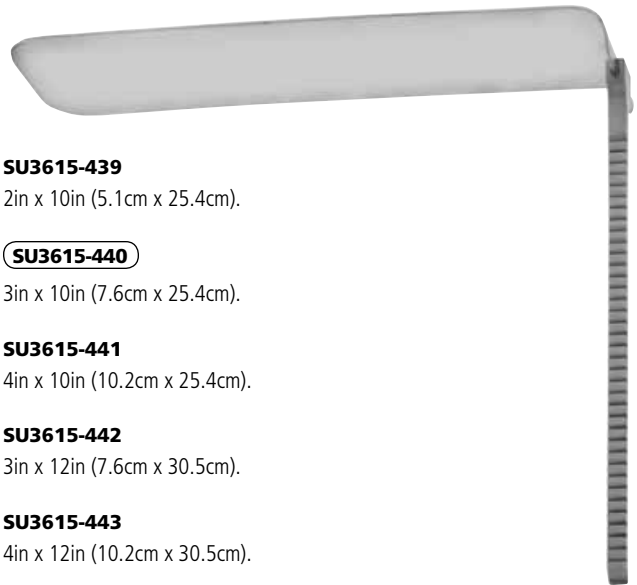

Larmes d'écarteur  
 Wundspreizerblätter  
 Lame divaricatore  
 Cuchillas de separadores  
 Láminas de retrator  
 リトラクターのブレード

**HARRINGTON Blade**

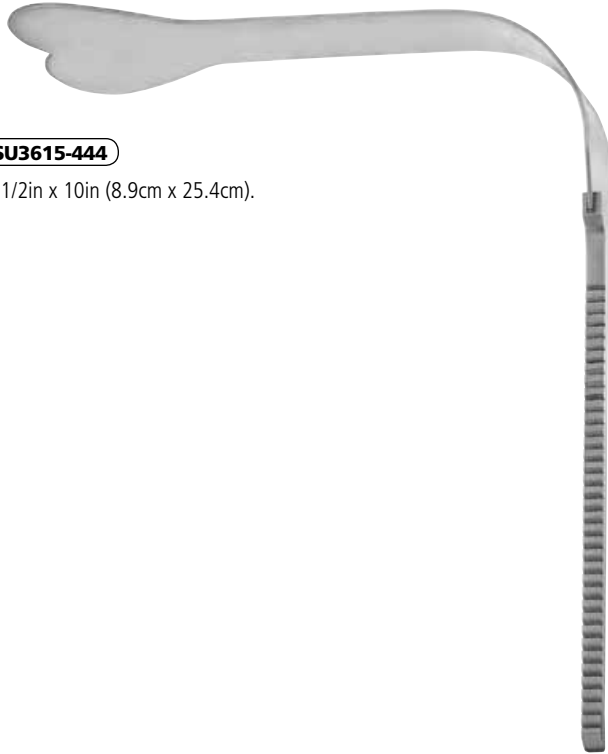

**SU3615-444**

3-1/2in x 10in (8.9cm x 25.4cm).

**KELLY Blade**



**SU3615-445**

2in x 8in (5.1cm x 20.3cm).

**Blades**

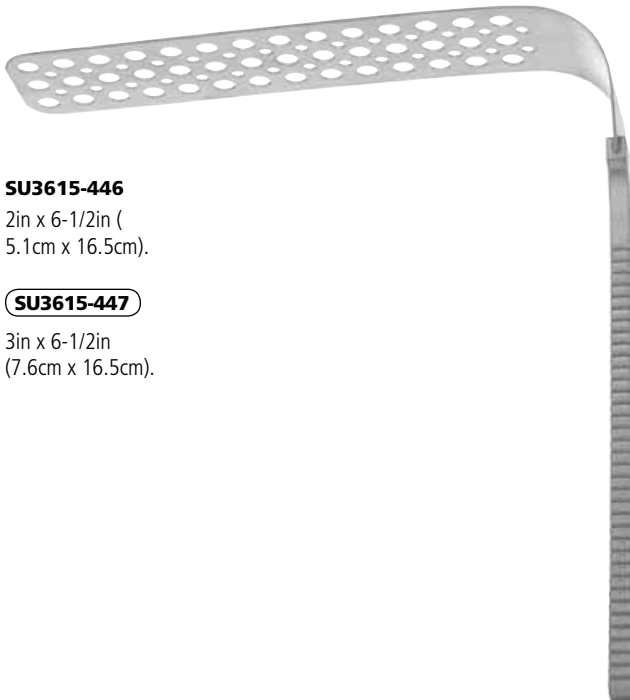

**SU3615-446**

2in x 6-1/2in (5.1cm x 16.5cm).

**SU3615-447**

3in x 6-1/2in (7.6cm x 16.5cm).

**BALFOUR Blade**

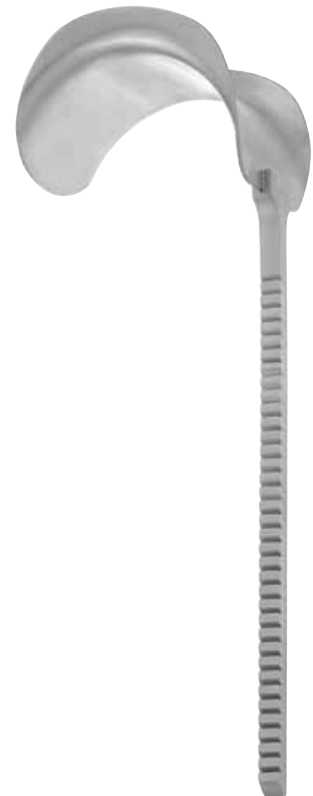

**SU3615-448**

3-1/2in x 2-3/4in (8.9cm x 7cm).

## Retractor Blades

Larmes d'écarteur  
Wundspreizerblätter  
Lame divaricatore  
Cuchillas de separadores  
Lâminas de retrator  
リトラクターのブレード

### Upper Hand Retractors

Sturdy aluminum side arms fit standard operating table, have socket-type connections to hold the blade support over the patient.

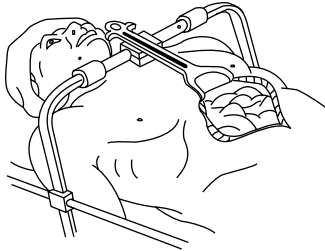

#### SU3085

Holds any 1 standard BALFOUR center blade.

#### SU3085-001

Holds any 2 standard BALFOUR blades or double blade support.



### MYERS Spiral Vein Strippers

Mirror finish.

#### SU11700

1/4in (6.4mm) olive. Working length 15in (38.1cm).

#### SU11701

1/4in (6.4mm) olive. Working length 25-1/4in (64.1cm).

#### SU11702

3/8in (9.5mm) olive. Working length 25-1/4in (64.1cm).

#### SU11704

1/2in (12.7mm) olive. Working length 39-3/8in (100cm).

#### SU11705

3/4in (19.1mm) olive. Working length 39-3/8in (100cm).



### Customer Support

Our highly trained, centralized V. Mueller customer support team is available to take your calls from 7:00 a.m. to 6:00 p.m. (CST), M-F. This group is dedicated to providing a full range of support services, including:

- Order placement
- Order inquiries
- Delivery information
- Product information
- Pricing inquiries

If we can be of assistance, please call us at **800.323.9088**.

**MYERS Interchangeable Vein Strippers**

Mirror finish.

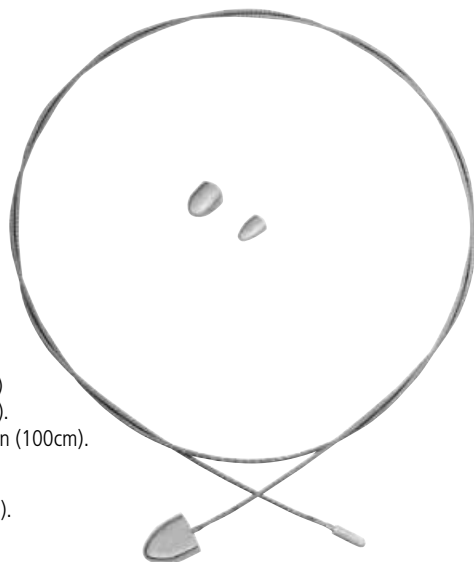
**SU11710**Olive 3/8in (9.5mm)  
and 1/2in (12.7mm).  
Staff length 39-3/8in (100cm).**SU11711037**

Olive. 3/8in (9.5mm).

**SU11711050**

Olive. 1/2in (12.7mm).

**SU11712**

Spiral coiled stainless wire, 39-3/8in (100cm) long, with 1/8in (3.2mm) olive at one end. Threaded 1/56 at both ends, fits all sizes of SU11711 series olives.

**Sterilizing and Storage Rack**

For SU11700 and SU11710. Mirror finish.

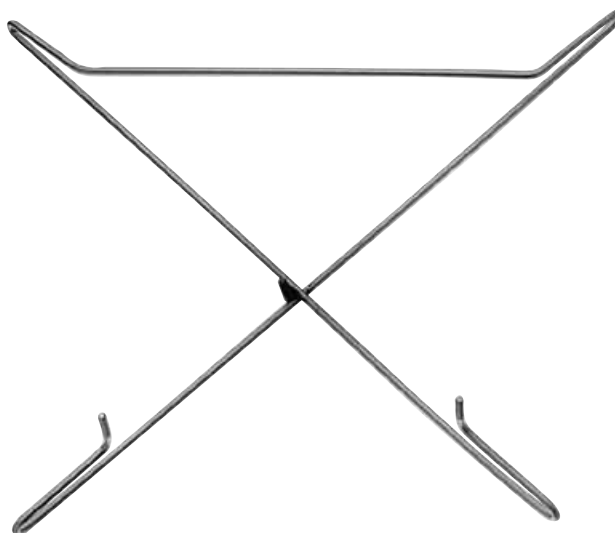
**SU11715****EMERSON Vein Stripper**

Includes two filiforms, threaded metal guide tip and sterilizing rack.

**SU11750**

Working length 37in (94cm).

**SU11755**Filiform 3cm 1/56in thread. Radiopaque.  
Coated with Polymer. Overall length 1-3/16in (3cm).**NABATOFF Vein Stripper**

Olives 9mm, 12mm and 15mm. Includes sterilizing case. Mirror finish.

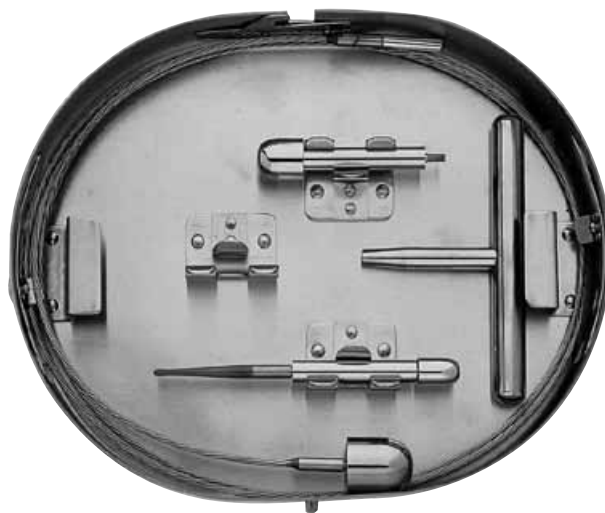
**SU11770**Overall length  
36in (91.4cm).

Miscellaneous

Divers  
 Verschiedenes  
 Varie  
 Varios  
 Diversos  
 その他

**MAYO-MYERS External Vein Strippers**

Straight shaft.  
 Overall length  
 15in (38.1cm).



**SU11855018**

Internal ring size  
 3/16in (5mm).

**SU11855028**

Internal ring size  
 9/32in (7mm).

**SU11855037**

Internal ring size  
 3/8in (10mm).

**MAYO External Vein Strippers**

Angled shaft.  
 Overall length  
 15in (38.1cm).



**SU11850018**

Internal ring size  
 3/16in (5mm).

**SU11850028**

Internal ring size  
 9/32in (7mm).

**SU11850037**

Internal ring size  
 3/8in (10mm).

**DIEFFENBACH Serrefines**

Overall length 2-1/4in (5.7cm).



**SU12550**

Straight.



**SU12551**

Curved.



**MYCOTIC Nail Nipper**

Concave blade. Double-action.

**SU15132**

Overall length  
 6in (15.2cm).



**Nail Nipper**

Straight, double spring.  
 Mirror finish.

**SU15100**

Overall length  
 5in (12.7cm).



**Nail Nipper**

Concave edge, double spring.  
 Mirror finish.

**SU15110**

Overall length  
 4-3/4in (12.1cm).



**Cuticle Nipper**

Convex edge, double spring.  
 Mirror finish.

**SU15085**

Overall length  
 4in (10.2cm).





Divers  
Verschiedenes  
Varie  
Varios  
Diversos  
その他

**Nail Nipper**

Concave edge,  
double spring.  
Mirror finish.

◆ **SU15120**

Overall length  
5-1/2in (14cm).

**Nail Nippers**

Concave edge.  
Barrel spring and  
catch in handles,  
screw lock.  
Mirror finish.

○ **SU15130**

Overall length  
4-3/4in (12.1cm).

**SU15131**

Overall length  
5-1/2in (14cm).

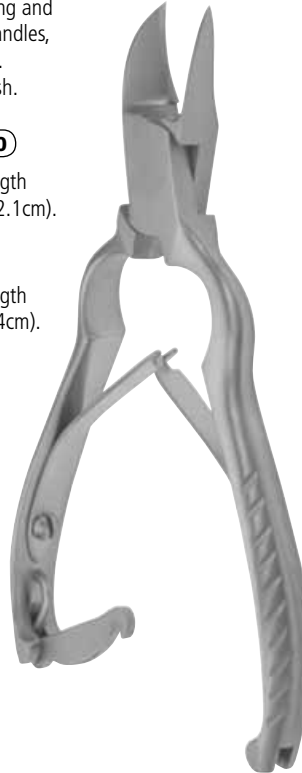
**KEYES Skin Punches**

Overall length 3-1/2in (8.9cm).

○ **SU15300001**

Diameter 1.5mm.

**SU15300002**

Diameter 2mm.

**SU15300003**

Diameter 3mm.

**SU15300004**

Diameter 4mm.

**SU15300005**

Diameter 5mm.

**SU15300006**

Diameter 6mm.

**SU15300007**

Diameter 7mm.

**SU15300008**

Diameter 8mm.

**FOX Dermal Curettes**

Overall length  
5-5/8in (14.3cm).

○ **SU15330003**

Diameter 3mm.

**SU15330004**

Diameter 4mm.

**SU15330005**

Diameter 5mm.

**SU15330006**

Diameter 6mm.

**SCHAMBERG Comedo Extractor**

Double-ended.

○ **SU15400**

Overall length  
3-3/4in (9.5cm).

**SAALFELD Comedo Extractors**

Double-ended,  
with lancet.

○ **SU15405**

Overall length  
5-3/4in (14.6cm).

**SU15410**

Overall length  
4-1/2in (11.5cm).

**UNNA Comedo Extractor**

Double-ended.  
Mirror finish.

○ **SU15415**

Overall length  
5-3/4in (14.6cm).



**Miscellaneous**

Divers  
 Verschiedenes  
 Varie  
 Varios  
 Diversos  
 その他

**RAYPORT Muscle Biopsy Clamps**

Disposable polypropylene clamps. For single use only. Sterile.

**SU130-1111**

Jaw 10mm wide.

◆ **SU130-1112**

Jaw 12mm wide.

**SU130-1113**

Jaw 16mm wide.



**PRICE Muscle Biopsy Clamps**

Double-pronged fork tips, with slide catch. Mirror finish.

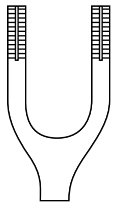

◆ **SU20910**

Jaws 8mm wide.

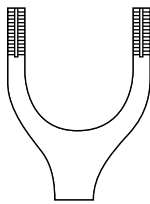

**SU20912**

Jaws 15mm wide.



**STAMEY Needles**

**SU2130-010**

Angled 10°.

**SU2130-015**

Angled 15°.

**SU2130-030**

Angled 30°.



**MENGHINI Liver Biopsy Set**

Complete with stopping plug, skin-perforating stylet, stylet for cleaning cannula and two adapters. Four sizes available. Mirror finish.

**SU21040001**

70mm x 1mm.

**SU21040002**

70mm x 1.2mm.

**SU21040003**

70mm x 1.4mm.

**SU21040004**

70mm x 1.6mm.

**SU21040005**

Replacement stopping plug for SU21040001, 70mm x 1mm.

**SU21040006**

Replacement stopping plug for SU21040002, 70mm x 1.2mm.

**SU21040007**

Replacement stopping plug for SU21040003, 70mm x 1.4mm.

**SU21040008**

Replacement stopping plug for SU21040004, 70mm x 1.6mm.

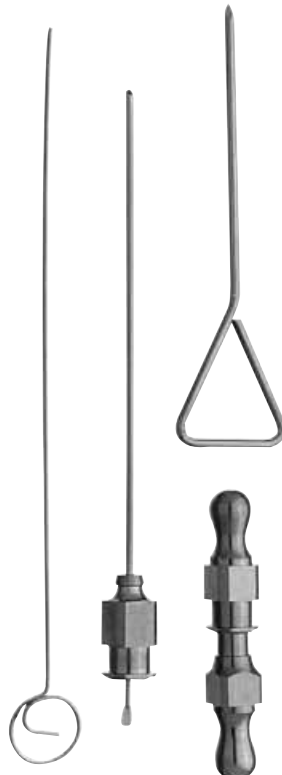

**FRANKLIN-SILVERMAN Biopsy Needles**

Luer hub is Nickel Plated.

**SU21060**

Outer cannula working length 3-3/8in (8.6cm). Cannula, hub overall length 4-7/8in (12.4cm). Inner split needle, hub overall length 5-5/8in (14.3cm).

**SU21061**

Outer cannula working length 4-1/2in (11.5cm). Cannula, hub overall length 6in (15.2cm). Inner split needle, hub overall length 6-3/4in (17.2cm).

**SU21062**

Outer cannula working length 6in (15.2cm). Cannula, hub overall length 7-1/2in (19cm). Inner split needle, hub overall length 8-1/4in (21cm).

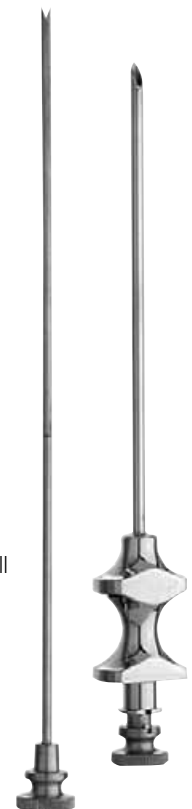

## Clip Removing Forceps

Pinces d'extraction pour agrafes  
Zange zum Entfernen von Clips  
Pinze per la rimozione di graffe  
Fórceps quitaclips  
Pinças removedoras de agrafos  
クリップ除去鉗子

### MICHEL Suture Clip Applying Forceps

SN365



### MICHEL Clip Applying/Removing Forceps

SN370



### HAGENBARTH Clip Applying Forceps

Cross-action.

SN375



### RICHTER Suture-Clip Removing Forceps

SN380



### WACHENFELDT Clip Applying Forceps

Cross-action.

SN385

Overall length  
4-3/4in (12cm).



### V. Mueller Instrument Warranty

We warranty every medical device and accessory bearing the V. Mueller brand name to be free of functional defects in workmanship and materials when used normally for its intended use. Any V. Mueller product proving to be so defective will be replaced or repaired at no charge. Repairs or modifications performed by unauthorized personnel may void all product warranties and could affect performance and efficacy of the device.

## Specula

Spéculum  
Spekula  
Speculum  
Espéculos  
検鏡

### HIRSCHMAN Anoscopes

Mirror and Satin finish.

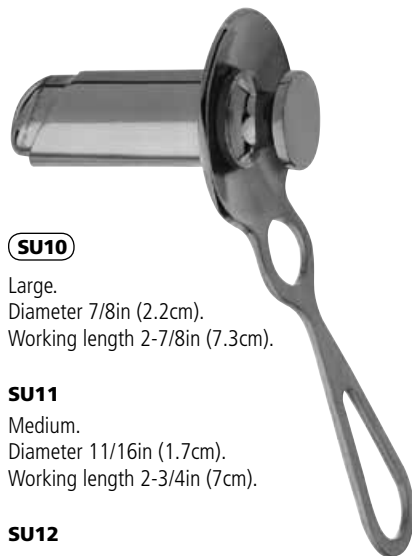

**SU10**

Large.  
Diameter 7/8in (2.2cm).  
Working length 2-7/8in (7.3cm).

**SU11**

Medium.  
Diameter 11/16in (1.7cm).  
Working length 2-3/4in (7cm).

**SU12**

Small.  
Diameter 9/16in (1.4cm).  
Working length 2-3/4in (7cm).

### BUIE-HIRSCHMAN Anoscopes

Mirror and Satin finish.



**SU20**

Large.  
Diameter 7/8in (2.2cm).  
Working length 3-7/8in (9.8cm).

**SU21**

Medium.  
Diameter 11/16in (1.7cm).  
Working length 3-3/4in (9.5cm).

**SU22**

Small.  
Diameter 9/16in (1.4cm).  
Working length 3-3/4in (9.5cm).

### IVES Anoscope

White Plastic obturator. Diameter 1in (2.5cm).



**SU30**

Working length 3-1/4in (8.3cm).

### FANSLER Proctoscope

Open at top. Diameter 1-1/3in (3.3cm).  
Mirror finish.



**SU220**

Working length 2-3/8in (6cm).

### VERNON-DAVID Rectal Speculum

Diameter 3/4in (2cm). Chrome Plated.



**SU40**

Overall length 3in (7.6cm).

### BRINKERHOFF Rectal Specula

Mirror finish.



**SU60**

Large.  
Diameter 3/4in x 1-1/4in (1.9cm x 3.2cm).  
Overall length 4-1/2in (11.4cm).

**SU61**

Medium.  
Diameter 5/8in x 1in (1.6cm x 2.5cm).  
Overall length 3-3/4in (9.5cm).

**SU62**

Small.  
Diameter 1/2in x 1in (1.3cm x 2.5cm).  
Overall length 3-3/4in (9.5cm).

**PRATT Rectal Speculum**

Bivalve type. Regular size.  
Mirror finish.

**SU110**

Blades 3-1/2in x 1in  
(8.9cm x 2.5cm) wide.

**CHELSEA EATON Anal Specula**

Mirror finish. Overall length 2-1/2in (6.4cm).

**SU210**

Small.  
Diameter 7/8in (2.2cm).

**SU211**

Large.  
Diameter 1-1/4in (3.1cm).

**SAWYER Retractors**

Mirror finish.

**SU164**

Small.  
Blade 2-3/4in x 3/4in  
(7cm x 1.9cm) wide.

**SU165**

Medium.  
Blade 3-1/4in x 1-1/8in  
(8.2cm x 2.9cm) wide.

**SU166**

Large.  
Blade 3-1/2in x 1-1/2in  
(9cm x 3.8cm) wide.

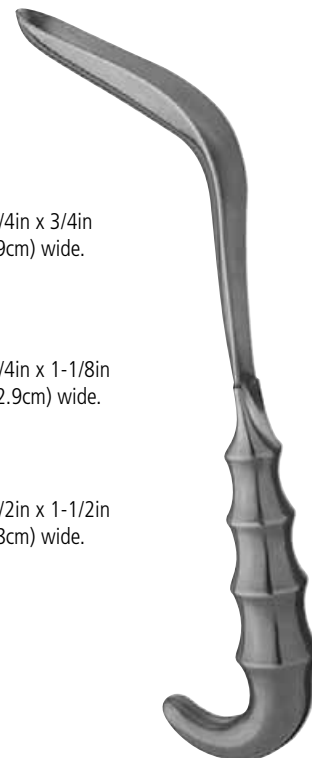
**FERGUSON-MOON Rectal Retractors**

Mirror and Satin finish.

**SU170**

Blade 3in x 1-3/8in  
(7.5cm x 3.5cm) wide.

**SU171**

Blade 2-3/8in x 15/16 wide  
(6cm x 2.4cm).

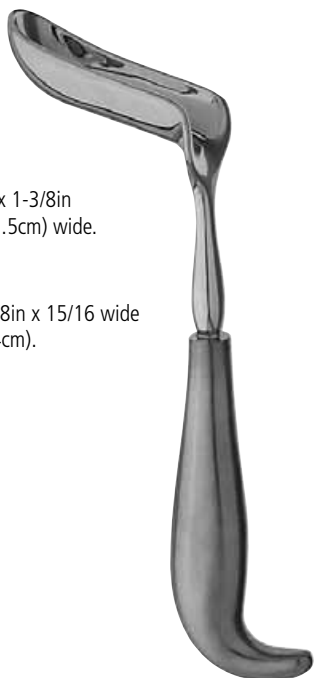
**HILL-FERGUSON Rectal Retractors**

Mirror and Satin finish.

**SU180**

Blade 3in x 1-3/8in  
(7.6cm x 3.5cm) wide.

**SU181**

Blade 2-1/2in x 15/16in  
(6.4cm x 2.4cm) wide.

**◆ SU182**

Blade 3in x 1-1/4in  
(7.6cm x 3.2cm) wide.

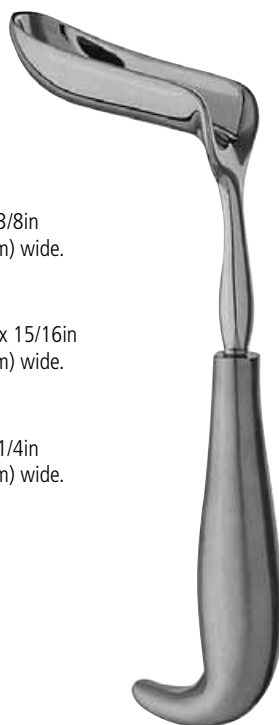
**BUIE-SMITH Anal Retractors**

Self-retaining. Swivel blades.  
Opens to 2-1/8in (5.4cm).

**SU290**

Short blade.  
2-7/8in x 7/8in  
(7.3cm x 2.2cm) wide.

**SU290-001**

Long blade.  
3-3/4in x 7/8in  
(9.5cm x 2.2cm) wide.



**Retractors/Forceps/Clamps**

Écarteurs/Forceps/Clamps  
 Wundspreizer/Retraktoren/Zangen/Klemmen  
 Divaricatori/Pinze/Morse  
 Separadores/Fórceps/Pinzas  
 Retratores/Fórceps/Piças  
 リトラクター/鉗子/クランプ

**PARKS Anal Retractor**

Self-retaining. Swivel blades.

◆ **SU295**

Includes two sets of side blades and one center blade.



**FERGUSON Tenaculum Forceps**

◆ **SU950**

Overall length 6-1/4in (15.9cm).



**ADAIR Tissue Forceps**

◆ **SU960**

Overall length 6-1/4in (15.9cm).



◆ **CH1565**

Overall length 9in (22.9cm).



**PRATT-SMITH Hemostatic Forceps**

Concave, T-shaped jaws, with delicate serrations.

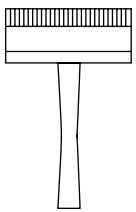

◆ **SU970**

Overall length 6in (15.2cm).

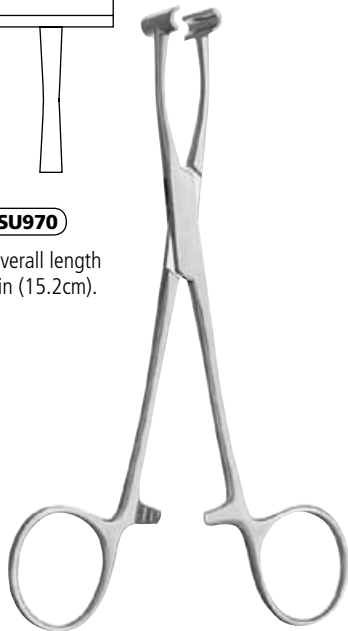

**PENNINGTON Hemorrhoidal Forceps**

Triangular open jaws have full horizontal serrations.

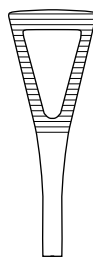

◆ **SU980**

Overall length 6-1/4in (15.9cm).

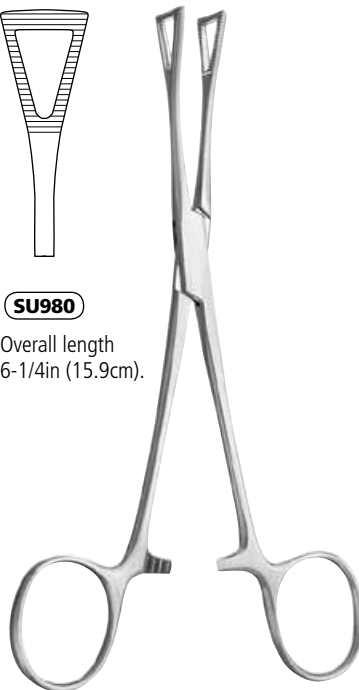

**BUIE Pile Clamp**

Model is serrated all the way to the heel of slightly curved and tapering jaws.



◆ **SU1000**

Overall length 8-1/4in (21cm).



Sondes/Crochets  
Sonden/Haken  
Sonde/Uncini  
Sondas/Ganchos  
Sondas/Ganchos  
プローブ/フック

**LARRY Rectal Director**

Grooved.  
Chrome Plated.

**SU740**

Overall length  
6in (15.2cm).



**BUIE Fistula Probes**

Silver Probe/Stainless  
Steel Handle.  
Overall length  
6-1/2in (16.5cm).

**SU760**

Light.

**SU761**

Heavy.



**PRATT Rectal Probe**

Malleable. Silver probe.  
Stainless Steel handle.

**SU770**

Overall length  
10in (25.4cm).



**BARR Fistula Probe**

Double-ended.  
Chrome Plated.

**SU780**

Overall length  
7in (17.8cm).



**EARLE Rectal Probe**

Mirror finish.

**SU790**

Overall length  
6-7/8in (17.5cm).

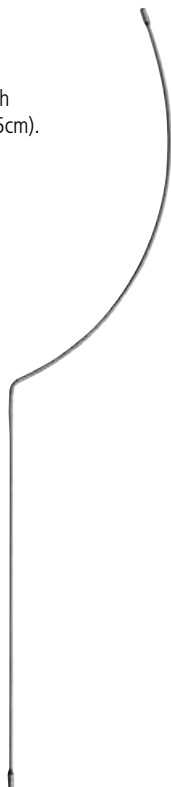

**LOCKHART-MUMMERY  
Fistula Probe**

Overall length  
6-1/2in (16.5cm).

**SU791**

No 1.  
Straight.

**SU792**

No 2.  
Slight curve.

**SU793**

No 3.  
Curved.

**SU794**

No 4.  
Heavy curve.



**ROSSER Crypt Hook**

Matte and Mirror finish.

**SU810**

Overall length  
6-5/8in (16.8cm).



**STEWART Crypt Hooks**

Overall length  
9in (22.9cm).

**SU860**

Short hook,  
length 7/8in (2.2cm).

**SU861**

Long hook,  
length 1-1/8in (2.9cm).



**Miscellaneous**

Divers  
 Verschiedenes  
 Varie  
 Varios  
 Diversos  
 その他

**McGIVNEY Hemorrhoidal Ligator**

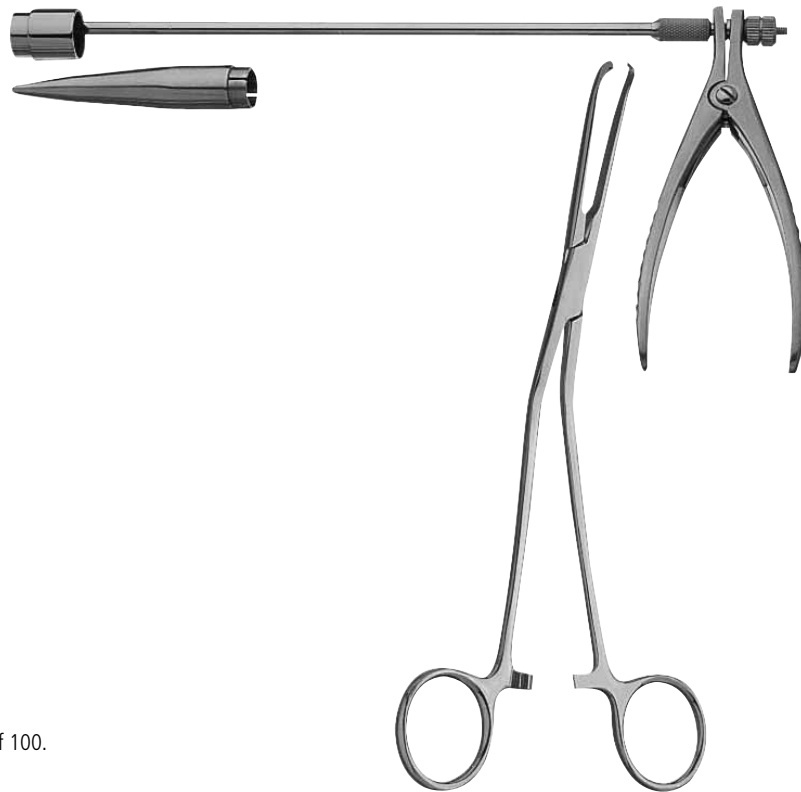

◆ **SU405**

Set includes: ligating drum, cone, 7-1/2in (19.1cm) grasping forceps, and one box Latex "O" Bands.

**SU405-1**

Ligator.

**SU405-2**

Overall length  
 7-1/2in (19.1cm).  
 Grasping forceps.

**SU405-3**

Cone.

**SU405-4**

Non-latex O bands.  
 For SU405-1 and SU410-01.

**SU406**

Latex "O" Bands.  
 For SU405 through SU410-4. Box of 100.

**FRANKFELDT Grasping Forceps**

Jaw opens to  
 1in (2.5cm).

**SU620**

Working length  
 14in (35.6cm).



**FRANKFELDT Rectal Snares**

Set includes insulated stem and hinged snare loop.

**SU660-014**

Overall length  
 14in (35.6cm).

**SU660-016**

Overall length  
 16in (40.6cm).

**SU662**

Stem bushing only.

**SU662-014**

Insulated stem only.  
 Overall length  
 14in (35.6cm).

**SU662-016**

Insulated stem only.  
 Overall length  
 16in (40.6cm).

**SU665-014**

Hinged wire loop only.  
 Overall length  
 14in (35.6cm).

**SU665-016**

Hinged wire loop only.  
 Overall length  
 16in (40.6cm).





**V. Mueller® Biopsy Forceps**

Alligator jaws with basket. Bite 3.5mm x 5.5mm.

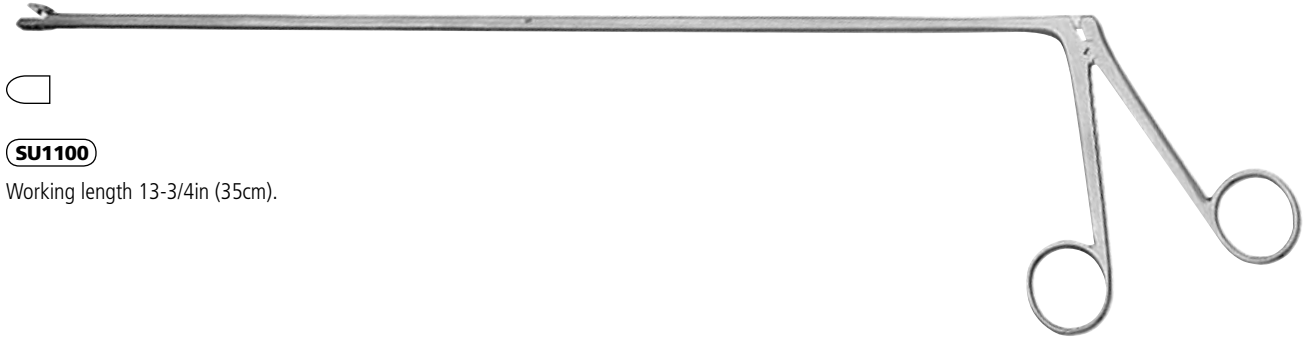

**SU1100**

Working length 13-3/4in (35cm).

**YEOMANS Biopsy Forceps**

Alligator jaws with basket. Bite 4mm x 12mm.



**SU1101**

Working length 13-3/4in (35cm).

**TURELL Specimen Forceps**

Alligator jaws with basket, 1/8in x 5/16in (3.2mm x 8mm) wide, angled 30°. Shaft rotates 360°.



**SU1115-016**

Working length 16in (40.6cm).

**Biopsy Forceps**

Alligator jaws with basket, 7/16in x 1/8in (1.1cm x 3mm) wide. Shaft rotates 360°.

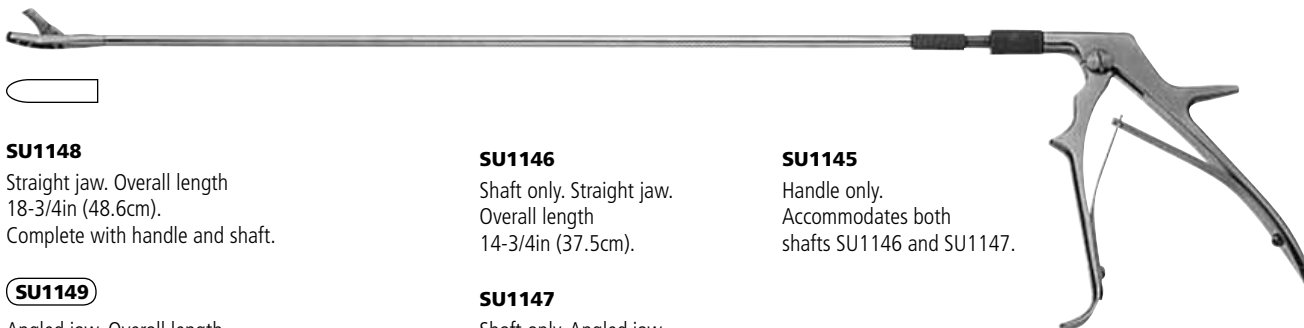

**SU1148**

Straight jaw. Overall length 18-3/4in (48.6cm). Complete with handle and shaft.

**SU1149**

Angled jaw. Overall length 18-3/4in (48.6cm). Complete with handle and shaft.

**SU1146**

Shaft only. Straight jaw. Overall length 14-3/4in (37.5cm).

**SU1147**

Shaft only. Angled jaw. Overall length 14-3/4in (37.5cm).

**SU1145**

Handle only. Accommodates both shafts SU1146 and SU1147.

